

Hypertherm[®]

Duramax™ Retrofit Torch HRT, MRT



Operator Manual – 807190

Revision 0

Duramax™ Retrofit Torch ***HRT, MRT***

Operator Manual **(P/N 807190)**

Revision 0 – January 2011

Hypertherm, Inc.
Hanover, NH USA
www.hypertherm.com
email: info@hypertherm.com

© 2011 Hypertherm, Inc.
All Rights Reserved

Hypertherm, Powermax, and Duramax are trademarks of Hypertherm, Inc.
and may be registered in the United States and/or other countries.

Hypertherm, Inc.

Etna Road, P.O. Box 5010
Hanover, NH 03755 USA
603-643-3441 Tel (Main Office)
603-643-5352 Fax (All Departments)
info@hypertherm.com (Main Office Email)
800-643-9878 Tel (Technical Service)
technical.service@hypertherm.com (Technical Service Email)
800-737-2978 Tel (Customer Service)
customer.service@hypertherm.com (Customer Service Email)

Hypertherm Automation

5 Technology Drive, Suite 300
West Lebanon, NH 03784 USA
603-298-7970 Tel
603-298-7977 Fax

Hypertherm Plasmatechnik GmbH

Technologiepark Hanau
Rodenbacher Chaussee 6
D-63457 Hanau-Wolfgang, Deutschland
49 6181 58 2100 Tel
49 6181 58 2134 Fax
49 6181 58 2123 (Technical Service)

Hypertherm (S) Pte Ltd.

82 Genting Lane
Media Centre
Annexe Block #A01-01
Singapore 349567, Republic of Singapore
65 6841 2489 Tel
65 6841 2490 Fax
65 6841 2489 (Technical Service)

Hypertherm (Shanghai) Trading Co., Ltd.

Unit A, 5th Floor, Careri Building
432 West Huai Hai Road
Shanghai, 200052
PR China
86-21 5258 3330/1 Tel
86-21 5258 3332 Fax

Hypertherm Europe B.V.

Vaartveld 9
4704 SE
Roosendaal, Nederland
31 165 596907 Tel
31 165 596901 Fax
31 165 596908 Tel (Marketing)
31 165 596900 Tel (Technical Service)
00 800 4973 7843 Tel (Technical Service)

Hypertherm Japan Ltd.

Level 9, Edobori Center Building
2-1-1 Edobori, Nishi-ku
Osaka 550-0002 Japan
81 6 6225 1183 Tel
81 6 6225 1184 Fax

Hypertherm Brasil Ltda.

Avenida Doutor Renato de
Andrade Maia 350
Parque Renato Maia
CEP 07114-000
Guarulhos, SP Brasil
55 11 2409 2636 Tel
55 11 2408 0462 Fax

Hypertherm México, S.A. de C.V.

Avenida Toluca No. 444, Anexo 1,
Colonia Olivar de los Padres
Delegación Álvaro Obregón
México, D.F. C.P. 01780
52 55 5681 8109 Tel
52 55 5683 2127 Fax

ELECTROMAGNETIC COMPATIBILITY (EMC)

Introduction

Hypertherm's CE-marked equipment is built in compliance with standard EN60974-10. The equipment should be installed and used in accordance with the information below to achieve electromagnetic compatibility.

The limits required by EN60974-10 may not be adequate to completely eliminate interference when the affected equipment is in close proximity or has a high degree of sensitivity. In such cases it may be necessary to use other measures to further reduce interference.

This cutting equipment is designed for use only in an industrial environment.

Installation and use

The user is responsible for installing and using the plasma equipment according to the manufacturer's instructions. If electromagnetic disturbances are detected then it shall be the responsibility of the user to resolve the situation with the technical assistance of the manufacturer. In some cases this remedial action may be as simple as earthing the cutting circuit, see *Earthing of Workpiece*. In other cases it could involve constructing an electromagnetic screen enclosing the power source and the work complete with associated input filters. In all cases electromagnetic disturbances must be reduced to the point where they are no longer troublesome.

Assessment of area

Before installing the equipment the user shall make an assessment of potential

electromagnetic problems in the surrounding area. The following shall be taken into account:

- a. Other supply cables, control cables, signalling and telephone cables; above, below and adjacent to the cutting equipment.
- b. Radio and television transmitters and receivers.
- c. Computer and other control equipment.
- d. Safety critical equipment, for example guarding of industrial equipment.
- e. Health of the people around, for example the use of pacemakers and hearing aids.
- f. Equipment used for calibration or measurement.
- g. Immunity of other equipment in the environment. User shall ensure that other equipment being used in the environment is compatible. This may require additional protection measures.
- h. Time of day that cutting or other activities are to be carried out.

The size of the surrounding area to be considered will depend on the structure of the building and other activities that are taking place. The surrounding area may extend beyond the boundaries of the premises.

Methods of reducing emissions

Mains supply

Cutting equipment must be connected to the mains supply according to the manufacturer's recommendations. If interference occurs, it may

be necessary to take additional precautions such as filtering of the mains supply. Consideration should be given to shielding the supply cable of permanently installed cutting equipment, in metallic conduit or equivalent. Shielding should be electrically continuous throughout its length. The shielding should be connected to the cutting mains supply so that good electrical contact is maintained between the conduit and the cutting power source enclosure.

Maintenance of cutting equipment

The cutting equipment must be routinely maintained according to the manufacturer's recommendations. All access and service doors and covers should be closed and properly fastened when the cutting equipment is in operation. The cutting equipment should not be modified in any way except as set forth in and in accordance with the manufacturer's written instructions. For example, the spark gaps of arc striking and stabilizing devices should be adjusted and maintained according to the manufacturer's recommendations.

Cutting cables

The cutting cables should be kept as short as possible and should be positioned close together, running at or close to the floor level.

Equipotential bonding

Bonding of all metallic components in the cutting installation and adjacent to it should be considered. However, metallic components bonded to the workpiece will increase the risk that the operator could receive a shock by touching these metallic components and the electrode (nozzle for laser heads) at the same time. The operator should be insulated from all such bonded metallic components.

Earthing of workpiece

Where the workpiece is not bonded to earth for electrical safety, nor connected to earth because of its size and position, for example, ship's hull or building steelwork, a connection bonding the workpiece to earth may reduce emissions in some, but not all instances. Care should be taken to prevent the earthing of the workpiece increasing the risk of injury to users, or damage to other electrical equipment. Where necessary, the connection of the workpiece to earth should be made by a direct connection to the workpiece, but in some countries where direct connection is not permitted, the bonding should be achieved by suitable capacitances selected according to national regulations.

Note: the cutting circuit may or may not be earthed for safety reasons. Changing the earthing arrangements should only be authorized by a person who is competent to assess whether the changes will increase the risk of injury, for example, by allowing parallel cutting current return paths which may damage the earth circuits of other equipment. Further guidance is provided in IEC 60974-9, Arc Welding Equipment, Part 9: Installation and Use.

Screening and shielding

Selective screening and shielding of other cables and equipment in the surrounding area may alleviate problems of interference. Screening of the entire plasma cutting installation may be considered for special applications.

Attention

Genuine Hypertherm parts are the factory-recommended replacement parts for your Hypertherm system. Any damage or injury caused by the use of other than genuine Hypertherm parts may not be covered by the Hypertherm warranty, and will constitute misuse of the Hypertherm Product.

You are solely responsible for the safe use of the Product. Hypertherm does not and cannot make any guarantee or warranty regarding the safe use of the product in your environment.

General

Hypertherm, Inc. warrants that its Products shall be free from defects in materials and workmanship for the specific periods of time set forth herein and as follows: if Hypertherm is notified of a defect (i) with respect to the power supply within a period of two (2) years from the date of its delivery to you, with the exception of Powermax brand power supplies, which shall be within a period of three (3) years from the date of delivery to you, and (ii) with respect to the torch and leads within a period of one (1) year from its date of delivery to you, and with respect to torch lifter assemblies within a period of one (1) year from its date of delivery to you, and with respect to laser heads within a period of one (1) year from its date of delivery to you, and with respect to Automation products one (1) year from its date of delivery to you, with the exception of the EDGE Pro CNC and ArcGlide THC, which shall be within a period of two (2) years from the date of delivery to you.

This warranty shall not apply to any Powermax brand power supplies that have been used with phase converters. In addition, Hypertherm does not warranty systems that have been damaged as a result of poor power quality, whether from phase converters or incoming line power. This warranty shall not apply to any Product which has been incorrectly installed, modified, or otherwise damaged.

Hypertherm provides repair, replacement or adjustment of the Product as the sole and exclusive remedy, if and only if the warranty set forth herein properly is invoked and applies. Hypertherm, at its sole option, shall repair, replace, or adjust, free of charge, any defective Products covered by this warranty which shall be returned with Hypertherm's prior authorization (which shall not be unreasonably withheld), properly packed, to Hypertherm's place of business in Hanover, New Hampshire, or to an authorized Hypertherm repair facility, all costs, insurance and freight pre paid by the customer. Hypertherm shall not be liable for any repairs, replacement, or adjustments of Products covered by this warranty, except those made pursuant to this paragraph and with Hypertherm's prior written consent.

The warranty set forth above is exclusive and is in lieu of all other warranties, express, implied, statutory, or otherwise with respect to the Products or as to the results which may be obtained therefrom, and all implied warranties or conditions of quality or of merchantability or fitness for a particular purpose or against infringement. The foregoing shall constitute the sole and exclusive remedy for any breach by Hypertherm of its warranty.

WARRANTY

Distributors/OEMs may offer different or additional warranties, but Distributors/OEMs are not authorized to give any additional warranty protection to you or make any representation to you purporting to be binding upon Hypertherm.

Distributors/OEMs may offer different or additional warranties, but Distributors/OEMs are not authorized to give any additional warranty protection to you or make any representation to you purporting to be binding upon Hypertherm.

Patent indemnity

Except only in cases of products not manufactured by Hypertherm or manufactured by a person other than Hypertherm not in strict conformity with Hypertherm's specifications and in cases of designs, processes, formulae, or combinations not developed or purported to be developed by Hypertherm, Hypertherm will have the right to defend or settle, at its own expense, any suit or proceeding brought against you alleging that the use of the Hypertherm product, alone and not in combination with any other product not supplied by Hypertherm, infringes any patent of any third party. You shall notify Hypertherm promptly upon learning of any action or threatened action in connection with any such alleged infringement (and in any event no longer than fourteen (14) days after learning of any action or threat of action), and Hypertherm's obligation to defend shall be conditioned upon Hypertherm's sole control of, and the indemnified party's cooperation and assistance in, the defense of the claim.

Limitation of liability

In no event shall Hypertherm be liable to any person or entity for any incidental, consequential direct, indirect, punitive or exemplary damages (including but not limited to lost profits) regardless of whether such liability is based on breach of contract, tort, strict liability, breach of warranty, failure of essential purpose, or otherwise, and even if advised of the possibility of such damages.

National and local codes

National and local codes governing plumbing and electrical installation shall take precedence over any instructions contained in this manual. In no event shall Hypertherm be liable for injury to persons or property damage by reason of any code violation or poor work practices.

Liability cap

In no event shall Hypertherm's liability, if any, whether such liability is based on breach of contract, tort, strict liability, breach of warranties, failure of essential purpose or otherwise, for any claim, action, suit or proceeding (whether in court, arbitration, regulatory proceeding or otherwise) arising out of or relating to the use of the Products exceed in the aggregate the amount paid for the Products that gave rise to such claim.

Insurance

At all times you will have and maintain insurance in such quantities and types, and with coverage sufficient and appropriate to defend and to hold Hypertherm harmless in the event of any cause of action arising from the use of the products.

Transfer of rights

You may transfer any remaining rights you may have hereunder only in connection with the sale of all or substantially all of your assets or capital stock to a successor in interest who agrees to be bound by all of the terms and conditions of this Warranty. Within thirty (30) days before any such transfer occurs, you agree to notify in writing Hypertherm, which reserves the right of approval. Should you fail timely to notify Hypertherm and seek its approval as set forth herein, the Warranty set forth herein shall be null and void and you will have no further recourse against Hypertherm under the Warranty or otherwise.

Electromagnetic compatibility	EMC-1
Warranty.....	W-1

Section 1**Specifications**

Component weights.....	1-2
Duramax HRT hand torch dimensions	1-2
Duramax MRT full-length machine torch dimensions	1-3
Duramax MRT without positioning sleeve (mini torch)	1-3

Section 2**Torch Setup**

Introduction	2-2
Consumable life.....	2-2
Hand torch setup	2-3
Choose the hand torch consumables	2-3
Hand torch consumables	2-4
Install the hand torch consumables.....	2-5
Machine torch setup.....	2-6
Converting a Duramax retrofit machine torch into a mini torch	2-7
Mount the torch.....	2-9
Choose the machine torch consumables	2-12
Machine torch consumables.....	2-12
Install the machine torch consumables	2-15
Aligning the torch	2-15
Torch installation	2-16

Section 3**Operation**

Using the cut charts	3-3
Estimated kerf-width compensation.....	3-3
100 amp mechanized shielded cutting for Powermax1650.....	3-6
85 amp mechanized shielded cutting for Powermax1650	3-8
80 amp mechanized shielded cutting for Powermax1250/1650	3-12
65 amp mechanized shielded cutting for Powermax1250/1650	3-14
60 amp mechanized shielded cutting for Powermax1000/1250/1650.....	3-18
45 amp mechanized shielded cutting for Powermax1000/1250/1650.....	3-20

TABLE OF CONTENTS

100 amp mechanized unshielded cutting for Powermax1650	3-24
85 amp mechanized unshielded cutting for Powermax1650.....	3-26
65 amp mechanized unshielded cutting for Powermax1250/1650	3-30
45 amp mechanized unshielded cutting for Powermax1000/1250/1650	3-34
FineCut® consumables for Powermax1000/1250/1650	3-38
Using the hand torch.....	3-41
Operate the safety trigger	3-41
Hand torch cutting hints	3-42
Start a cut from the edge of the workpiece.....	3-43
Pierce a workpiece.....	3-44
Gouge a workpiece	3-45
Common hand-cutting faults	3-48
Using the machine torch	3-49
Ensure the torch and table are set up correctly	3-49
Understand and optimize cut quality.....	3-49
To pierce a workpiece using the machine torch	3-52
Common machine-cutting faults.....	3-52

Section 4

Maintenance and parts

Perform routine maintenance	4-2
Inspect the consumables	4-3
Hand torch replacement parts	4-4
Machine torch replacement parts	4-5
Accessory parts.....	4-6

Section 1

SPECIFICATIONS

In this section:

Component weights	1-2
Duramax HRT hand torch dimensions	1-2
Duramax MRT full-length machine torch dimensions	1-3
Duramax MRT without positioning sleeve (mini torch)	1-3

SPECIFICATIONS

Component weights

Torch type	Weight – lbs (kg)
Hand torch 25 ft (7.6 m)	7.1 (3.2)
Hand torch 50 ft (15 m)	12.5 (5.7)
Machine torch 25 ft (7.6 m)	7.6 (3.4)
Machine torch 50 ft (15 m)	13.2 (6.0)

Duramax HRT hand torch dimensions

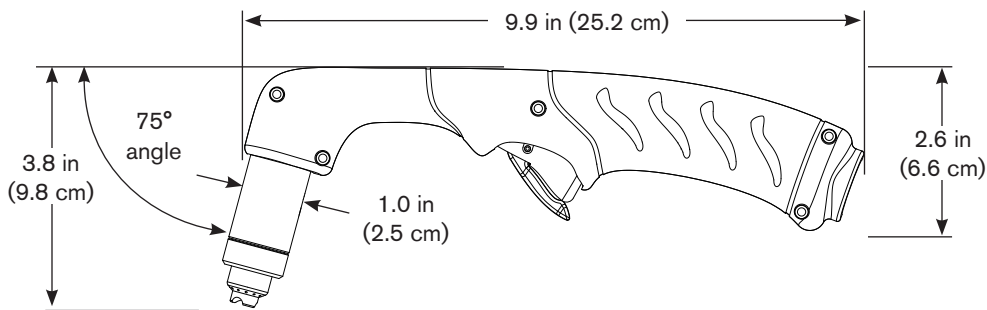

Duramax MRT full-length machine torch dimensions

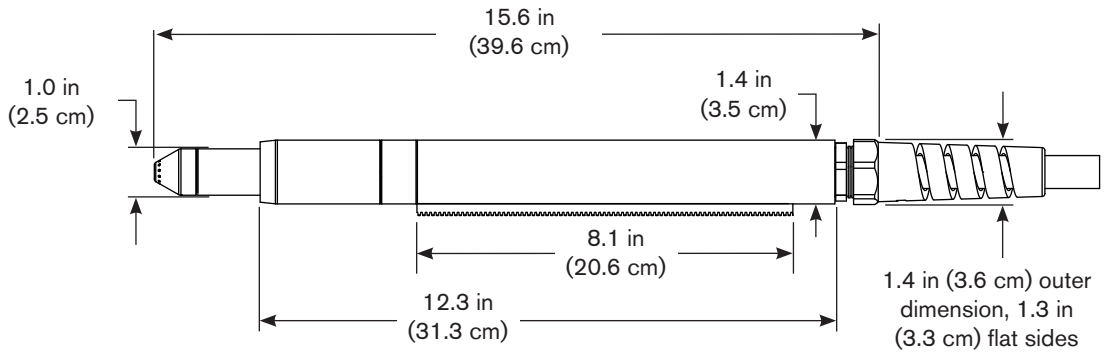

Duramax MRT without positioning sleeve (mini torch) dimensions

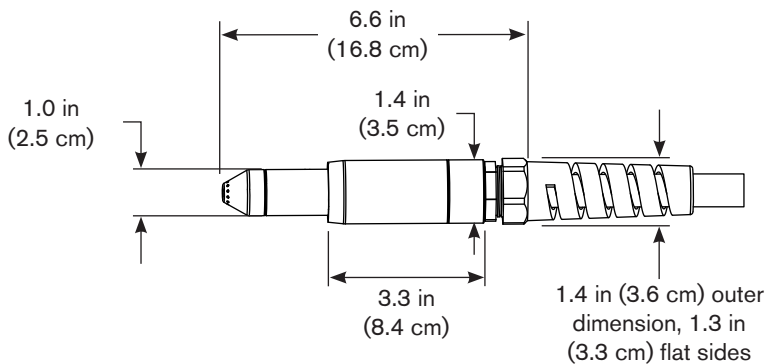

SPECIFICATIONS

Section 2

TORCH SETUP

In this section:

Introduction	2-2
Consumable life.....	2-2
Hand torch setup	2-3
Choose the hand torch consumables	2-3
Hand torch consumables	2-4
Install the hand torch consumables.....	2-5
Machine torch setup.....	2-6
Converting a Duramax retrofit machine torch into a mini torch	2-7
Mount the torch.....	2-9
Choose the machine torch consumables	2-12
Machine torch consumables.....	2-12
Install the machine torch consumables	2-15
Aligning the torch	2-15
Torch installation	2-16

Introduction

Duramax™ series handheld and machine retrofit torches are available for the Powermax1000, Powermax1250, and Powermax1650 systems. The ETR (Easy Torch Removal)™ quick-disconnect system makes it easy to remove the torch for transport or to switch from one torch to the other if your applications require the use of different torches. The torches are cooled by ambient air and do not require special cooling procedures.

This section explains how to setup your torch and choose the appropriate consumables for the job.

Consumable life

How often you need to change the consumables on your retrofit torch will depend on a number of factors:

- Thickness of the material – the thicker the material being cut, the more often consumables need to be changed.
- Average length of cut – the longer the average cut, the more often consumables need to be changed.
- Type of cutting – handheld cutting will require more consumable changes than machine cutting.
- Air quality – the presence of oil, moisture, or other contaminants will reduce consumable life.
- Piercing / edge starting – piercing the metal causes more consumable wear than starting cuts from the edge of the metal.
- Proper torch-to-work distance – when gouging or cutting with unshielded consumables, maintaining proper torch-to-work distance will result in better consumable life.
- Proper pierce height – maintaining proper pierce height will result in better consumable life.
- Cutting in “continuous pilot arc” mode or normal cutting mode – cutting with a continuous pilot arc causes more consumable wear than cutting in normal cutting mode.

You will find more information about proper cutting techniques in Section 3, *Operation*.

Hand torch setup

Duramax HRT

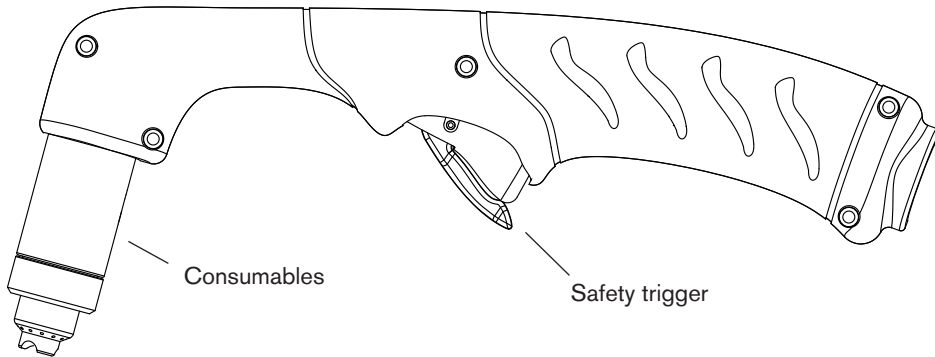

Choose the hand torch consumables

Duramax retrofit torches are shipped with a full set of cutting consumables pre-installed. Hypertherm also includes spare cutting electrodes, nozzles, and gouging consumables in the consumables box, for handheld torches.

Consumables for handheld cutting are shown on the next page. Notice that the retaining cap and electrode are the same for cutting, gouging, and FineCut® applications. Only the shield, nozzle, and swirl ring are different.

For the best cut quality on thin materials, you may prefer to use FineCut consumables, or use a 45 A nozzle and reduce the current setting to 45 amps.

TORCH SETUP

Hand torch consumables

Drag-cutting consumables: Powermax1000/1250/1650

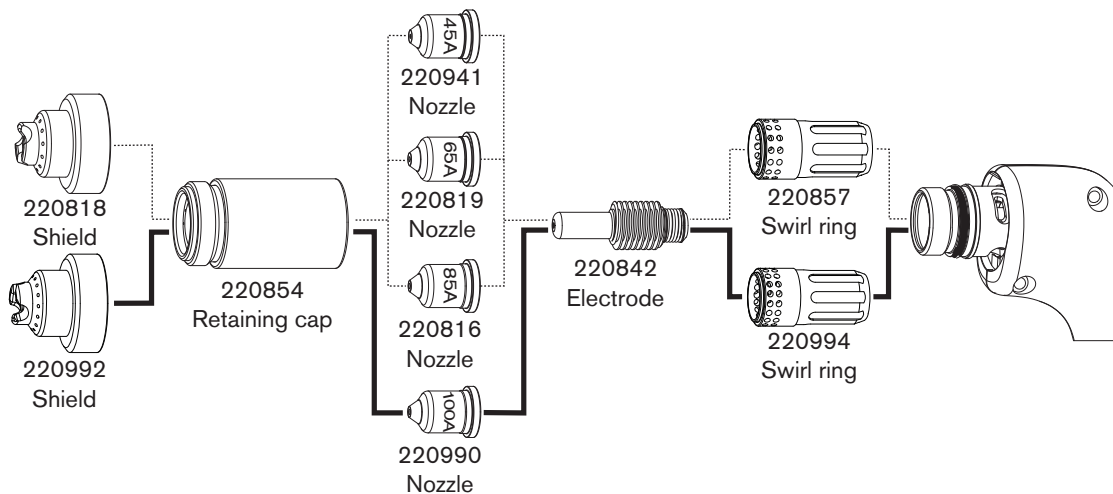

Gouging consumables: Powermax1000/1250/1650

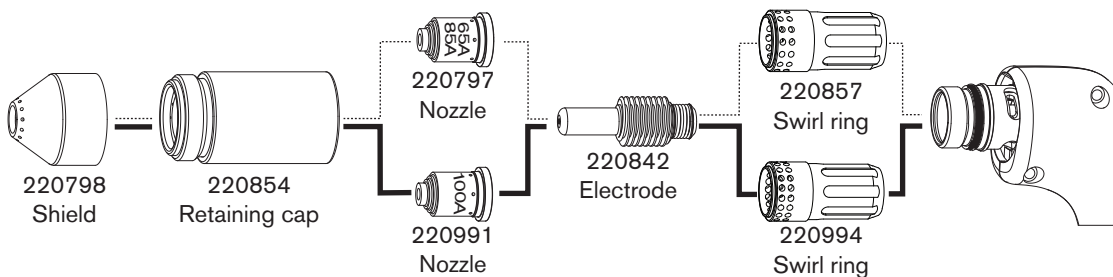

FineCut® consumables: Powermax1000/1250/1650

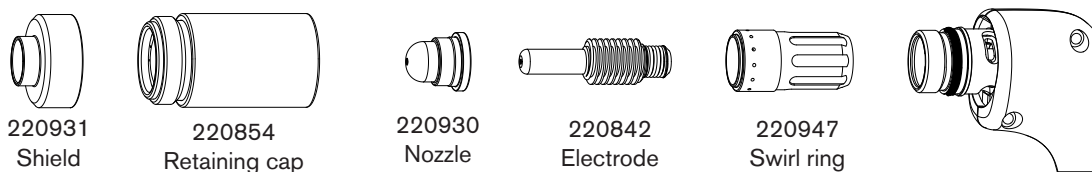

Powermax1000 – Use 45-65 A consumables
Powermax1250 – Use 45-85 A consumables
Powermax1650 – Use 45-100 A consumables

Install the hand torch consumables

		<p>WARNING INSTANT-ON TORCHES PLASMA ARC CAN CAUSE INJURY AND BURNS</p>
	<p>The plasma arc comes on immediately when the torch trigger is activated. Make sure the power is OFF before changing consumables.</p>	

To operate the hand torch, a complete set of consumable parts must be installed: shield, retaining cap, nozzle, electrode, and swirl ring.

With the power switch in the OFF (O) position, install the torch consumables as shown below.

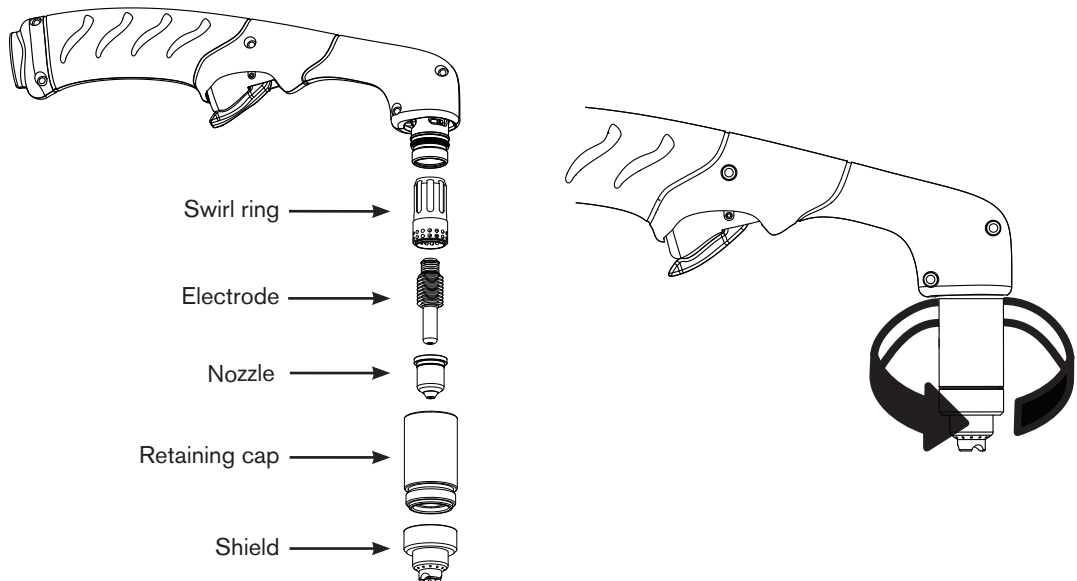

Machine torch setup

Duramax MRT

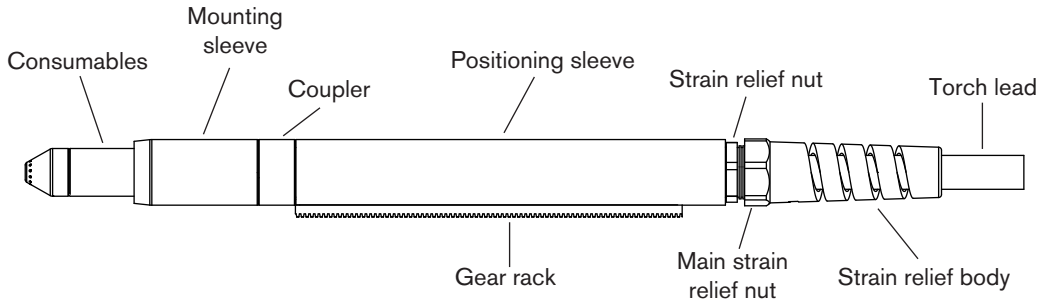

Duramax MRT without positioning sleeve (mini torch)

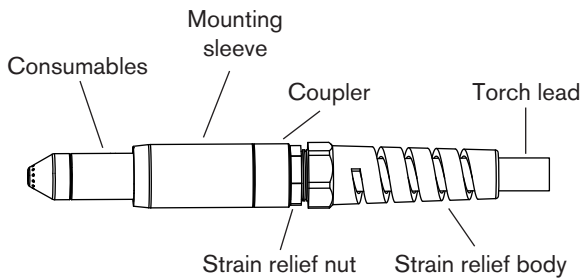

Before using either style of machine torch, you must:

- Mount the torch on your cutting table or other equipment.
- Choose and install the consumables.
- Align the torch.
- Attach the torch lead to the power supply.
- Set up the power supply for remote starting with either the remote-start pendant or a machine interface cable.

Converting a Duramax retrofit machine torch into a mini torch

You can convert a full-length machine torch to a mini-machine torch by removing the positioning sleeve.

Note: If you are converting a full-length machine torch to a mini-machine torch *and* mounting the torch at the same time, skip this section and follow the instructions in “Mount the torch” on page 2-9.

Refer to the figures in the section “Machine torch setup” on page 2-6 and follow these instructions.

Note: While disconnecting and reconnecting the torch parts, maintain the same orientation between the torch head and torch lead. Twisting the torch head in relation to the torch lead can cause damage.

1. Disconnect the torch lead from the power supply and remove the consumables from the torch.
2. Unscrew the strain relief body from the strain relief nut and slide the strain relief body back along the torch lead.
3. Unscrew the strain relief nut from the positioning sleeve and slide the nut back along the torch lead.
4. Unscrew the positioning sleeve from the coupler.
5. Unscrew the coupler from the mounting sleeve.
6. Remove the three screws from the consumables end of the mounting sleeve and slide the mounting sleeve off the front of the torch body.

TORCH SETUP

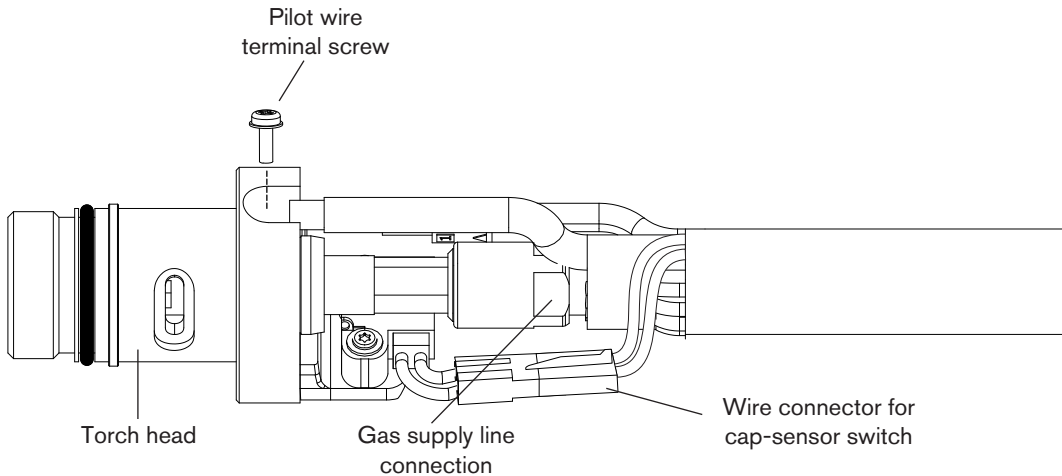

7. Disconnect the wire connector for the cap-sensor switch.
8. Use a #2 Phillips screwdriver to remove the screw that secures the torch's pilot wire to the torch body.
9. Use 1/4-inch and 3/8-inch wrenches, or adjustable wrenches, to loosen the nut that secures the gas supply line to the torch lead. Set the torch body aside.
10. Slide the coupler and positioning sleeve off the front of the torch lead.
11. Slide the coupler over the torch lead.
12. Reconnect the gas line to the torch lead.
13. Reattach the torch's pilot wire to the torch body using the screw.
14. Reconnect the cap-sensor switch's wire connector.
15. Slide the mounting sleeve over the front of the torch body. Align the slot on the front of the mounting sleeve (next to one of the three screw holes) with the cap-sensor plunger on the torch body.
16. Attach the mounting sleeve to the torch body using the three screws.
17. Screw the coupler into the mounting sleeve.
18. Screw the strain relief nut into the coupler.
19. Screw the strain relief body into the strain relief nut.

Mount the torch

Depending on the type of cutting table you have, you may or may not need to disassemble the torch to route it through the track and mount it. If your cutting table's track is large enough for you to thread the torch through it without removing the torch body from the lead, do so and then attach the torch to the lifter per the manufacturer's instructions.

Note: The Duramax machine torches can be mounted on a wide variety of X-Y tables, track burners, pipe bevelers, and other equipment. Install the torch per the manufacturer's instructions and follow the instructions below for disassembly if necessary.

If you need to disassemble and reassemble the torch, refer to the figures in the section "Machine torch setup" on page 2-6 and follow these instructions.

Note: While disconnecting and reconnecting the torch parts, maintain the same orientation between the torch head and torch lead. Twisting the torch head in relation to the torch lead can cause damage.

1. Disconnect the torch lead from the power supply and remove the consumables from the torch.
2. Unscrew the strain relief body from the strain relief nut and slide the strain relief body back along the torch lead.
3. Unscrew the strain relief nut from the positioning sleeve (full-length machine torch) and slide the nut back along the torch lead.
4. Unscrew the positioning sleeve from the coupler.
5. Unscrew the coupler from the mounting sleeve.
6. Remove the three screws from the consumables end of the mounting sleeve and slide the mounting sleeve off the front of the torch body.

TORCH SETUP

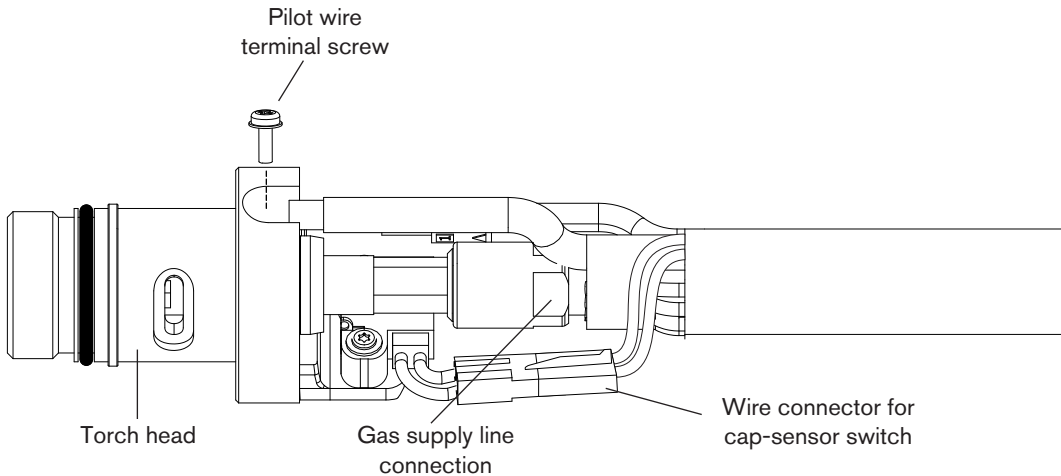

7. Disconnect the wire connector for the cap-sensor switch.
8. Use a #2 Phillips screwdriver to remove the screw that secures the torch's pilot wire to the torch body.
9. Use 1/4-inch and 3/8-inch wrenches, or adjustable wrenches, to loosen the nut that secures the gas supply line to the torch lead. Set the torch body aside.

Note: Cover the end of the gas line on the torch lead with tape to keep dirt and other contaminants from getting in the gas line when you route the lead through the track.

10. Slide the coupler, positioning sleeve (full-length machine torch), strain relief nut, and strain relief body off the front of the torch lead.
11. If you do not need the gear rack on a full-length machine torch, slide the gear rack from the positioning sleeve toward the consumables end of the sleeve.
12. Route the torch lead through the cutting table's track.

13. Slide the strain relief body and strain relief nut over the torch lead.
14. If you are mounting a full-length machine torch, slide the positioning sleeve over the torch head.
15. Slide the coupler over the torch lead.
16. Reconnect the gas line to the torch lead.
17. Reattach the torch's pilot wire to the torch body using the screw.
18. Reconnect the cap-sensor switch's wire connector.
19. Slide the mounting sleeve over the front of the torch body. Align the slot on the front of the mounting sleeve (next to one of the three screw holes) with the cap-sensor plunger on the torch body.
20. Attach the mounting sleeve to the torch body using the three screws.
21. Screw the coupler into the mounting sleeve.
22. If you are mounting a full-length machine torch, screw the positioning sleeve into the coupler.
23. Reconnect the strain relief nut and strain relief body.
24. Attach the torch to the lifter per the manufacturer's instructions.

TORCH SETUP

Choose the machine torch consumables

Powermax systems with the Duramax MRT retrofit torch are shipped with a complete set of consumables. Hypertherm also includes spare electrodes and nozzles. In addition, an ohmic-sensing retaining cap is available for use with shielded consumables. With shielded consumables, the torch tip may touch the metal when cutting. With unshielded consumables, you must keep the torch a small distance, about .08 inch (2 mm), away from the metal. Unshielded consumables generally have a shorter life than shielded consumables.

Machine torch consumables

Mechanized shielded consumables: Powermax1000/1250/1650

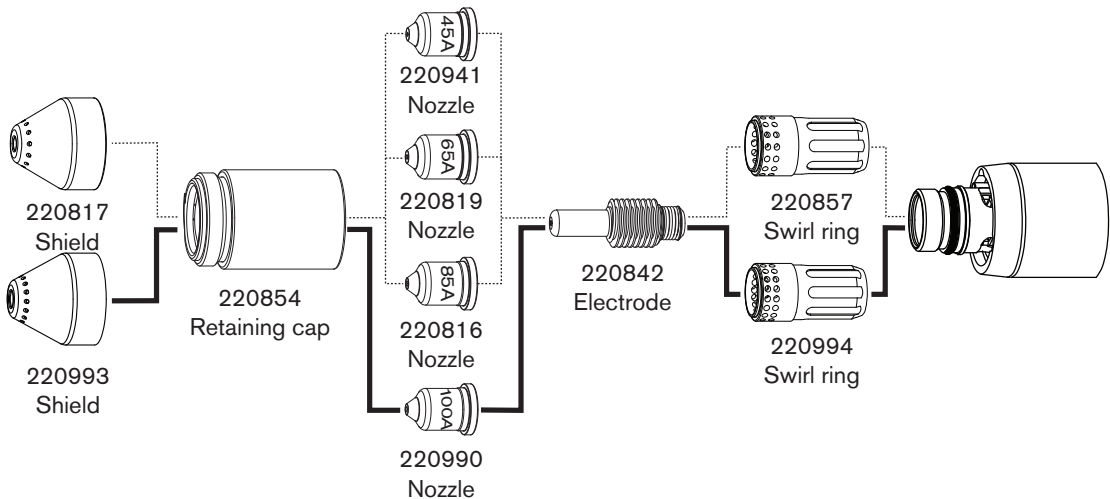

Powermax1000 – Use 45-65 A consumables
Powermax1250 – Use 45-85 A consumables
Powermax1650 – Use 45-100 A consumables

Mechanized shielded with ohmic consumables: Powermax1000/1250/1650

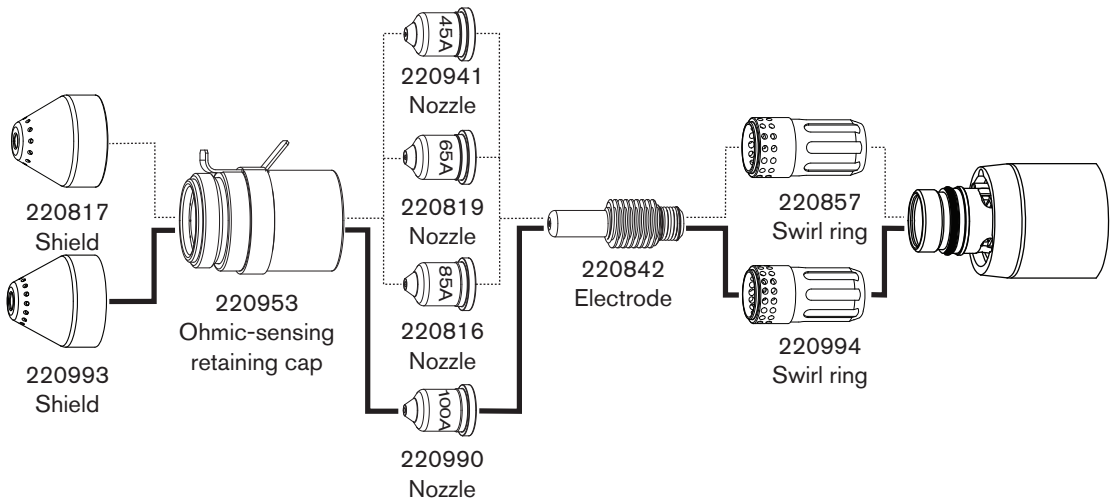

Mechanized unshielded consumables: Powermax1000/1250/1650

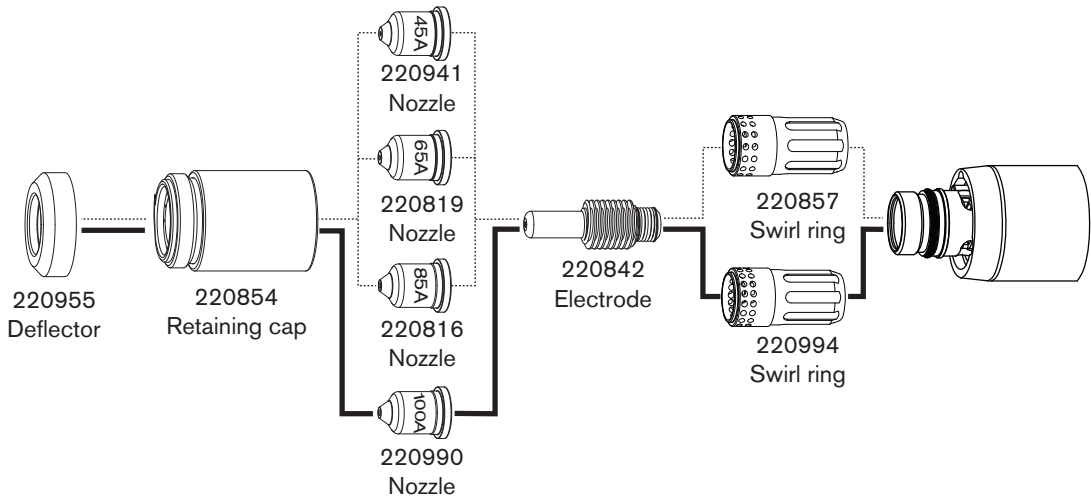

Powermax1000 – Use 45-65 A consumables
 Powermax1250 – Use 45-85 A consumables
 Powermax1650 – Use 45-100 A consumables

TORCH SETUP

Gouging consumables: Powermax1000/1250/1650

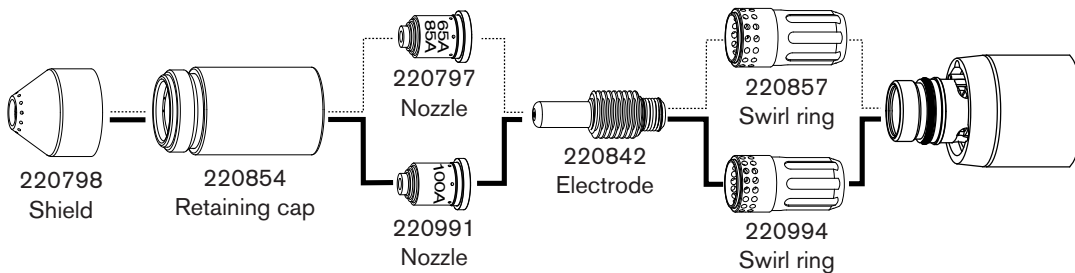

FineCut® shielded consumables: Powermax1000/1250/1650

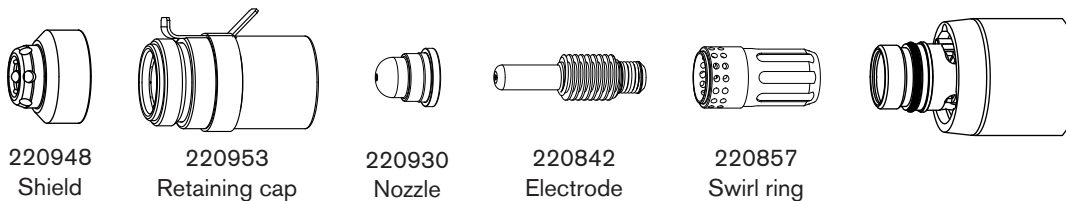

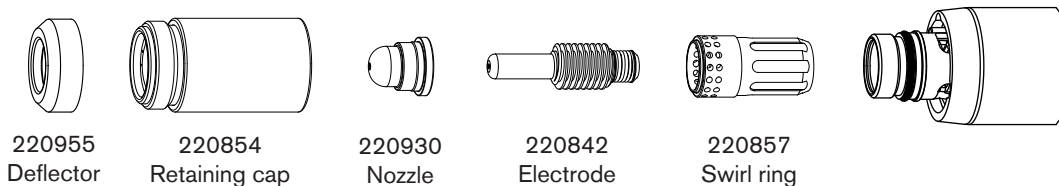

FineCut® unshielded consumables: Powermax1000/1250/1650



Powermax1000 – Use 45-65 A consumables
Powermax1250 – Use 45-85 A consumables
Powermax1650 – Use 45-100 A consumables

Install the machine torch consumables

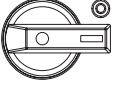
		<p style="text-align: center;">WARNING INSTANT-ON TORCHES PLASMA ARC CAN CAUSE INJURY AND BURNS</p>
	<p>The plasma arc comes on immediately when the torch is activated. Make sure the power is OFF before changing the consumables.</p>	

To operate the machine torch, a complete set of consumable parts must be installed: shield, retaining cap, nozzle, electrode, and swirl ring.

With the power switch in the OFF (O) position, install the machine torch consumables in a manner similar to the hand torch consumables. Refer to “Install the hand torch consumables” on page 2-5.

Aligning the torch

Mount the machine torch perpendicular to the workpiece in order to get a vertical cut. Use a square to align the torch at 0° and 90°.

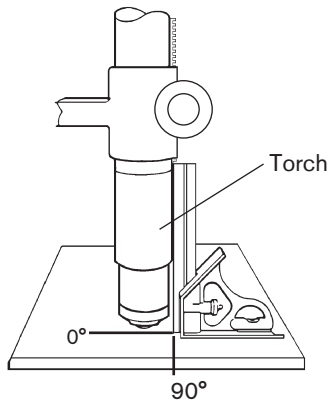

TORCH SETUP

Torch installation

1. Turn OFF the power.

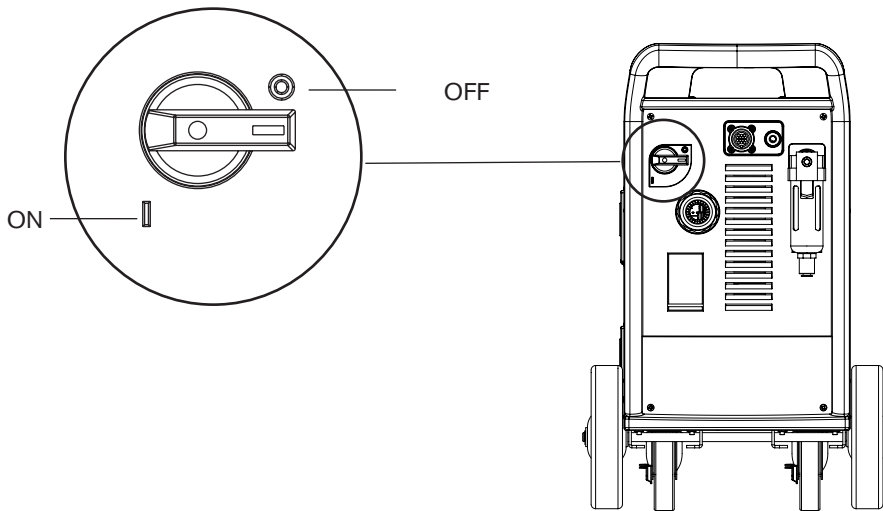

2. Remove the power cord from the power receptacle.

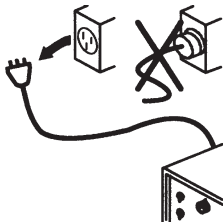

3. Open the Easy Torch Removal (ETR) door and route the lead through the end cap.

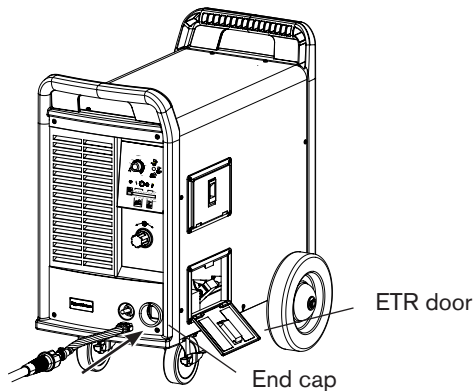

4. Align the marks on the strain relief.

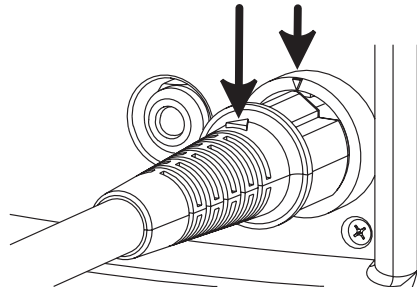

5. Pull back the quick-release collar and insert the lead's gas fitting.

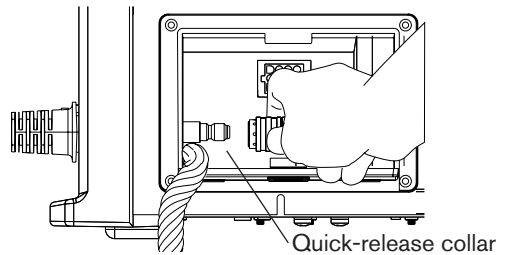

6. Slide the quick-release collar forward to lock the gas fitting in place. Make sure that the gas fitting is secure.

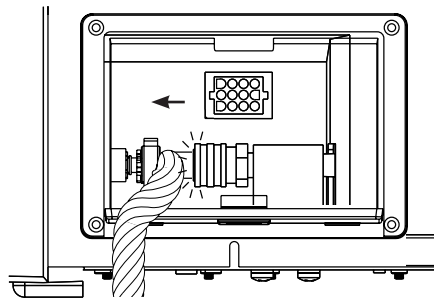

7. Make sure that the red dot on the connector is on top, then plug in the electrical connector.

Close the ETR door.

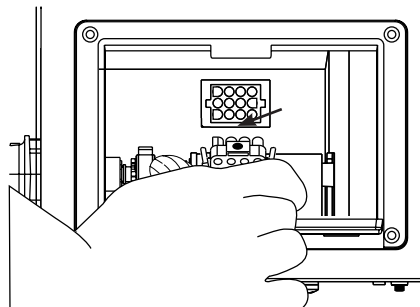

Section 3

OPERATION

In this section:

Using the cut charts	3-3
Estimated kerf-width compensation.....	3-3
100 amp mechanized shielded cutting for Powermax1650.....	3-6
85 amp mechanized shielded cutting for Powermax1650	3-8
80 amp mechanized shielded cutting for Powermax1250/1650	3-12
65 amp mechanized shielded cutting for Powermax1250/1650	3-14
60 amp mechanized shielded cutting for Powermax1000/1250/1650.....	3-18
45 amp mechanized shielded cutting for Powermax1000/1250/1650.....	3-20
100 amp mechanized unshielded cutting for Powermax1650	3-24
85 amp mechanized unshielded cutting for Powermax1650.....	3-26
65 amp mechanized unshielded cutting for Powermax1250/1650	3-30
45 amp mechanized unshielded cutting for Powermax1000/1250/1650	3-34
FineCut® consumables for Powermax1000/1250/1650	3-38
Using the hand torch.....	3-41
Operate the safety trigger	3-41
Hand torch cutting hints	3-42
Start a cut from the edge of the workpiece.....	3-43
Pierce a workpiece.....	3-44
Gouge a workpiece	3-45
Common hand-cutting faults	3-48

OPERATION

Using the machine torch3-49

- Ensure the torch and table are set up correctly3-49
- Understand and optimize cut quality.....3-49
- To pierce a workpiece using the machine torch3-52
- Common machine-cutting faults.....3-52

Using the cut charts

The following sections provide cut charts for each set of mechanized consumables. A consumable diagram with part numbers precedes each section.

The arc voltage increases as the consumables wear and the voltage setting should be increased to maintain the correct Torch-to-Work Distance.

Note: Hypertherm collected the data under laboratory test conditions using new consumables.

Estimated kerf-width compensation

The widths in the tables on the following two pages are for reference. The data is obtained with the “Best Quality” settings. Differences between installations and material composition may cause actual results to vary from those shown in the tables.

OPERATION

Estimated kerf-width compensation – Metric (mm)

Process	Thickness (mm)									
	0.5	1	2	3	6	8	10	12	16	20
Mild Steel										
100 A Shielded					2.0	2.1	2.2	2.2	2.3	2.7
85 A Shielded				1.7	1.8	1.9	2.0	2.2	2.4	2.6
80 A Shielded				1.7	1.7	1.8	1.8	1.8	2.0	2.3
65 A Shielded			1.6	1.6	1.8	1.9	2.0	2.2	2.3	
60 A Shielded			1.4	1.4	1.6	1.6	1.7	1.8	1.9	
45 A Shielded	1.1	1.1	1.4	1.5	1.7					
FineCut	0.7	0.7	1.3	1.3						
85 A Unshielded			1.7	1.8	1.9	2.0	2.1	2.1	2.3	
65 A Unshielded			1.6	1.6	1.7	1.8	1.9	2.0		
45 A Unshielded	0.5	0.9	1.3	1.3						
Stainless Steel										
100 A Shielded					1.9	1.9	2.0	2.1	2.2	2.3
85 A Shielded				1.6	1.8	1.9	2.1	2.3	2.4	2.5
80 A Shielded				1.7	1.7	1.8	1.8	1.9	2.1	2.2
65 A Shielded			1.4	1.5	1.8	1.9	2.0	2.2	2.4	
60 A Shielded			1.5	1.5	1.6	1.7	1.8	1.8	2.0	
45 A Shielded	0.9	1.1	1.5	1.6	1.8					
FineCut	0.6	0.6	1.4	1.5						
85 A Unshielded			1.7	1.7	1.8	1.9	2.1	2.2	2.4	
65 A Unshielded			1.6	1.6	1.8	1.8	1.9	2.0		
45 A Unshielded	0.5	1.0	1.3	1.5	1.5					
Aluminum										
100 A Shielded					2.1	2.1	2.1	2.1	2.1	2.3
85 A Shielded				2.0	1.9	2.0	2.1	2.2	2.4	2.6
80 A Shielded				1.7	1.7	1.7	1.8	1.8	1.8	
65 A Shielded			1.9	1.9	1.9	2.0	2.1	2.3	2.5	
60 A Shielded			1.5	1.5	1.5	1.5	1.6	1.6	1.6	
45 A Shielded		1.5	1.5	1.6	1.5					
85 A Unshielded			1.9	1.9	1.9	2.0	2.0	2.1	2.2	
65 A Unshielded			1.8	1.8	1.8	1.8	1.9	2.0		
45 A Unshielded		1.6	1.5	1.4	1.5					

Estimated kerf-width compensation – English (inches)

Process	Thickness (inches)									
	22 GA	18 GA	14 GA	10 GA	3/16	1/4	3/8	1/2	5/8	3/4
	Mild Steel									
100 A Shielded						0.079	0.085	0.085	0.089	0.107
85 A Shielded				0.068	0.071	0.073	0.078	0.090	0.095	0.100
80 A Shielded					0.068	0.068	0.071	0.073	0.078	0.088
65 A Shielded			0.062	0.065	0.068	0.070	0.076	0.088	0.090	0.091
60 A Shielded			0.055	0.057	0.060	0.063	0.067	0.071	0.076	0.084
45 A Shielded	0.035	0.054	0.055	0.061	0.065	0.066				
FineCut	0.024	0.043	0.049	0.051						
85 A Unshielded				0.070	0.073	0.075	0.080	0.085	0.090	
65 A Unshielded			0.062	0.064	0.066	0.068	0.075	0.081		
45 A Unshielded	0.020	0.050	0.051	0.054	0.057	0.059				
Stainless Steel										
100 A Shielded						0.074	0.079	0.083	0.087	0.090
85 A Shielded				0.068	0.071	0.073	0.078	0.090	0.095	0.100
80 A Shielded						0.066	0.072	0.077	0.082	0.088
65 A Shielded			0.062	0.065	0.068	0.070	0.076	0.088	0.090	0.091
60 A Shielded						0.065	0.069	0.073	0.080	0.088
45 A Shielded	0.035	0.054	0.055	0.061	0.065	0.066				
FineCut	0.024	0.043	0.049	0.051						
85 A Unshielded				0.070	0.073	0.075	0.080	0.085	0.090	
65 A Unshielded			0.062	0.064	0.066	0.068	0.075	0.081		
45 A Unshielded	0.020	0.050	0.051	0.054	0.057	0.059				
Aluminum										
		1/32	1/16	1/8	3/16	1/4	3/8	1/2	5/8	3/4
100 A Shielded						0.083	0.085	0.080	0.084	0.089
85 A Shielded				0.080	0.078	0.075	0.080	0.090	0.095	0.100
80 A Shielded				0.069		0.065	0.072	0.069	0.075	
65 A Shielded			0.073	0.074	0.075	0.076	0.083	0.091	0.100	
60 A Shielded			0.064	0.061		0.057	0.061	0.063	0.065	
45 A Shielded		0.059	0.061	0.065		0.060				
85 A Unshielded				0.075	0.075	0.075	0.080	0.082	0.088	
65 A Unshielded			0.070	0.070	0.070	0.070	0.072	0.079		
45 A Unshielded		0.062	0.058	0.057		0.061				

OPERATION

100 amp mechanized shielded cutting for Powermax1650

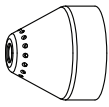

220993
Shield

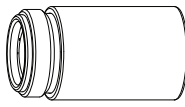

220854
Retaining cap



220990
Nozzle

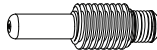

220842
Electrode

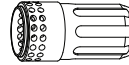

220994
Swirl ring

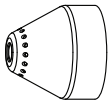
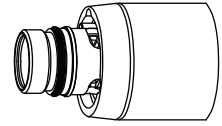

220993
Shield

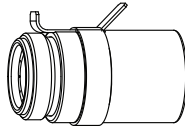

220953
Ohmic-sensing
retaining cap



220990
Nozzle

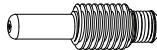

220842
Electrode

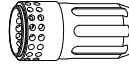

220994
Swirl ring

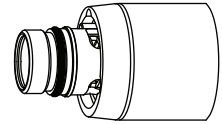

- Recommended cut speeds are a good starting point for finding the best quality cut (best angle, least dross, and best cut-surface finish). Adjust the speed for your application and table to obtain the desired cut quality.
- Maximum cut speeds are the fastest speeds possible to cut material without regard to cut quality.

Note: Torch-to-work distance for the following cut chart is 1/8 in (3.2 mm) for all cuts.

Mild steel

Arc current	Arc voltage	Pierce delay	Material thickness		Recommended cut speed		Maximum cut speed	
			in	mm	ipm	mm/min	ipm	mm/min
100	153	0.5	1/4	6.4	135	3429	208	5283
	155	0.5	3/8	9.5	77	1955	119	3022
	159	1.0	1/2	12.7	57	1447	88	2235
	160	1.0	5/8	15.9	40	1016	61	1549
	161	1.5	3/4	19.0	26	660	47	1193
	163	NA	1	25.4	18	457	28	711
	167		1 1/4	31.8	12	305	19	482

Stainless steel

Arc current	Arc voltage	Pierce delay	Material thickness		Recommended cut speed		Maximum cut speed	
			in	mm	ipm	mm/min	ipm	mm/min
100	154	0.5	1/4	6.4	150	3810	231	5867
	156	0.5	3/8	9.5	79	2006	122	3099
	161	1.0	1/2	12.7	52	1320	79	2006
	162	1.0	5/8	15.9	34	863	52	1320
	164	1.5	3/4	19.0	25	635	39	990
	166	NA	1	25.4	15	381	23	584
	169		1 1/4	31.8	9	228	14	355

Aluminum

Arc current	Arc voltage	Pierce delay	Material thickness		Recommended cut speed		Maximum cut speed	
			in	mm	ipm	mm/min	ipm	mm/min
100	154	0.5	1/4	6.4	164	4165	253	6426
	157	0.5	3/8	9.5	92	2336	142	3606
	160	1.0	1/2	12.7	70	1778	108	2743
	161	1.0	5/8	15.9	50	1270	77	1955
	162	1.5	3/4	19.0	33	838	57	1447
	165	NA	1	25.4	21	533	33	838

OPERATION

85 amp mechanized shielded cutting for Powermax1650

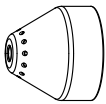

220817
Shield

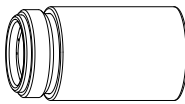

220854
Retaining cap



220816
Nozzle

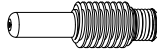

220842
Electrode

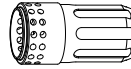

220857
Swirl ring

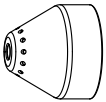
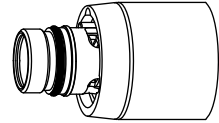

220817
Shield

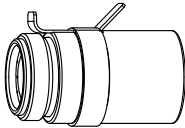

220953
Ohmic-sensing
retaining cap



220816
Nozzle

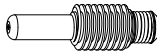

220842
Electrode

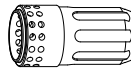

220857
Swirl ring

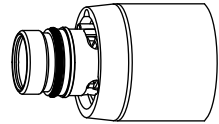

- Best Quality Settings (cut speed and voltage) — Settings that provide the starting point for finding the best cut quality (best angle, least dross, best cut-surface finish). Adjust the speed for your application and table to obtain the desired result.
- Production Settings (cut speed and voltage) — 80% of the maximum speed ratings. These speeds result in the greatest number of cut parts, but not necessarily the best possible cut quality.

**85 A Shielded
Mild Steel**

Metric

Material Thickness	Torch-to-Work Distance	Initial Pierce Height		Pierce Delay Time	Best Quality Settings		Production Settings		
					Cut Speed	Voltage	Cut Speed	Voltage	
mm	mm	mm	%	seconds	mm/min	Volts	mm/min	Volts	
3	1.5	3.8	250	0.1	6800	122	9200	120	
4				0.2	5650	122	7300	122	
6				0.5	3600	123	4400	125	
8					2500	125	3100	127	
10					1680	127	2070	128	
12		4.5	300	0.7	1280	130	1600	130	
16				1.0	870	134	930	133	
20		6.0	400	1.5	570	137	680	136	
25		Edge Start				350	142	450	141
30						200	146	300	144

English

Material Thickness	Torch-to-Work Distance	Initial Pierce Height		Pierce Delay Time	Best Quality Settings		Production Settings		
					Cut Speed	Voltage	Cut Speed	Voltage	
in	in	in	%	seconds	ipm	Volts	ipm	Volts	
10 GA	0.06	0.15	250	0.0	250	122	336	121	
3/16				0.2	185	123	220	123	
1/4				0.5	130	123	160	126	
3/8					70	126	86	127	
1/2					45	131	56	131	
5/8		0.18	300	1.0	35	134	37	133	
3/4				0.24	400	1.5	24	136	29
7/8		Edge Start				19	139	22	138
1						13	142	17	141
1-1/8						9	145	13	143
1-1/4					7	148	10	146	

OPERATION

85 A Shielded Stainless Steel

Metric

Material Thickness	Torch-to-Work Distance	Initial Pierce Height		Pierce Delay Time	Best Quality Settings		Production Settings	
					Cut Speed	Voltage	Cut Speed	Voltage
mm	mm	mm	%	seconds	mm/min	Volts	mm/min	Volts
3	1.5	3.8	250	0.1	7500	122	9200	120
4				0.2	6100	122	7500	120
6				0.5	3700	122	4600	122
8					2450	124	3050	124
10		4.5	300	1550	127	1900	126	
12				0.7	1100	131	1400	130
16				1.0	700	135	760	134
20				Edge Start		480	138	570
25		Edge Start		300	143	370	141	

English

Material Thickness	Torch-to-Work Distance	Initial Pierce Height		Pierce Delay Time	Best Quality Settings		Production Settings	
					Cut Speed	Voltage	Cut Speed	Voltage
in	in	in	%	seconds	ipm	Volts	ipm	Volts
10 GA	0.06	0.15	250	0.2	275	122	336	120
3/16					200	122	240	121
1/4				0.5	130	122	164	122
3/8					65	126	80	125
1/2		0.18	300	36	132	48	131	
5/8				1.0	28	135	30	134
3/4		Edge Start		20	137	24	136	
7/8		Edge Start		16	140	19	139	
1		Edge Start		11	143	14	141	

**85 A Shielded
Aluminum**

Metric

Material Thickness	Torch-to-Work Distance	Initial Pierce Height		Pierce Delay Time	Best Quality Settings		Production Settings	
					Cut Speed	Voltage	Cut Speed	Voltage
mm	mm	mm	%	seconds	mm/min	Volts	mm/min	Volts
3	1.5	3.8	250	0.1	8000	122	9400	121
4				0.2	6500	123	8000	123
6				0.5	3800	126	4900	126
8		2650	130		3470	129		
10		1920	132		2500	131		
12		4.5	300	0.7	1450	134	1930	133
16				1.0	950	139	1200	137
20		Edge Start			600	143	880	141
25					380	146	540	144

English

Material Thickness	Torch-to-Work Distance	Initial Pierce Height		Pierce Delay Time	Best Quality Settings		Production Settings	
					Cut Speed	Voltage	Cut Speed	Voltage
in	in	in	%	seconds	ipm	Volts	ipm	Volts
1/8	0.06	0.15	250	0.2	300	122	360	121
1/4				0.5	130	127	172	127
3/8					80	132	104	131
1/2		0.18	300		50	135	68	133
5/8				1.0	38	139	48	137
3/4		Edge Start			25	142	37	140
7/8					20	144	29	142
1					14	146	20	144

OPERATION

80 amp mechanized shielded cutting for Powermax1250/1650

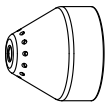

220817
Shield

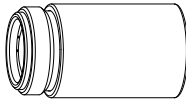

220854
Retaining cap



220816
Nozzle

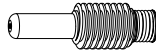

220842
Electrode

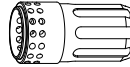

220857
Swirl ring

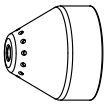
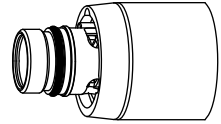

220817
Shield

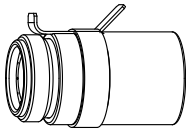

220953
Ohmic-sensing
retaining cap



220816
Nozzle

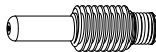

220842
Electrode

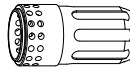

220857
Swirl ring

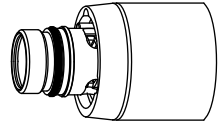

- Recommended cut speeds are a good starting point for finding the best quality cut (best angle, least dross, and best cut-surface finish). Adjust the speed for your application and table to obtain the desired cut quality.
- Maximum cut speeds are the fastest speeds possible to cut material without regard to cut quality.

Note: Torch-to-work distance for the following cut chart is 1/16 in (1.5 mm) for all cuts.

Mild steel

Arc current	Arc voltage	Pierce delay	Material thickness		Recommended cut speed		Maximum cut speed	
			in	mm	ipm	mm/min	ipm	mm/min
80	132	0.25	3/16	4.8	140	3556	216	5486
	134	0.50	1/4	6.4	105	2667	161	4089
	137		3/8	9.5	61	1549	94	2388
	140		1/2	12.7	39	991	60	1524
	145	1.0	5/8	15.9	26	660	40	1016
	148	N/A	3/4	19.0	20	508	31	787
	150		7/8	22.2	15	381	23	584
	156		1	25.4	10	254	16	406

Stainless steel

Arc current	Arc voltage	Pierce delay	Material thickness		Recommended cut speed		Maximum cut speed	
			in	mm	ipm	mm/min	ipm	mm/min
80	134	0.25	3/16	4.8	140	3556	216	5486
	136	0.50	1/4	6.4	103	2616	158	4013
	139	0.75	3/8	9.5	54	1372	83	2108
	142		1/2	12.7	33	838	50	1270
	145	1.0	5/8	15.9	22	559	34	864
	150	N/A	3/4	19.0	16	406	24	610
	153		1	25.4	9	229	14	356

Aluminum

Arc current	Arc voltage	Pierce delay	Material thickness		Recommended cut speed		Maximum cut speed	
			in	mm	ipm	mm/min	ipm	mm/min
80	134	0.25	1/8	3.2	295	7493	454	11532
	139		1/4	6.4	114	2896	176	4470
	143	0.75	3/8	9.5	60	1524	121	3073
	146		1/2	12.7	37	940	75	1905
	154	N/A	3/4	19.0	19	483	37	940

OPERATION

65 amp mechanized shielded cutting for Powermax1250/1650

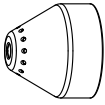

220817
Shield

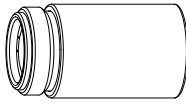

220854
Retaining cap



220819
Nozzle

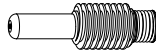

220842
Electrode

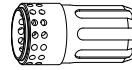

220857
Swirl ring

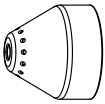
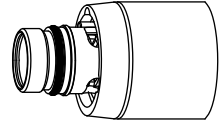

220817
Shield

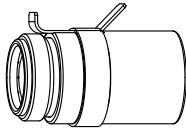

220953
Ohmic-sensing
retaining cap



220819
Nozzle

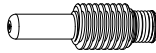

220842
Electrode

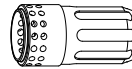

220857
Swirl ring

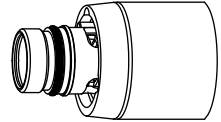

- Best Quality Settings (cut speed and voltage) — Settings that provide the starting point for finding the best cut quality (best angle, least dross, best cut-surface finish). Adjust the speed for your application and table to obtain the desired result.
- Production Settings (cut speed and voltage) — 80% of the maximum speed ratings. These speeds result in the greatest number of cut parts, but not necessarily the best possible cut quality.

**65 A Shielded
Mild Steel**

Metric

Material Thickness	Torch-to-Work Distance	Initial Pierce Height		Pierce Delay Time	Best Quality Settings		Production Settings		
					Cut Speed	Voltage	Cut Speed	Voltage	
mm	mm	mm	%	seconds	mm/min	Volts	mm/min	Volts	
2	1.5	3.8	250	0.1	6050	124	7000	121	
3				0.2	5200	125	6100	123	
4				0.5	4250	125	5100	124	
6					2550	127	3240	127	
8					1700	129	2230	128	
10		4.5	300	0.7	1100	131	1500	129	
12				1.2	850	134	1140	131	
16		6.0	400	2.0	560	138	650	136	
20		Edge Start				350	142	450	142
25						210	145	270	145

English

Material Thickness	Torch-to-Work Distance	Initial Pierce Height		Pierce Delay Time	Best Quality Settings		Production Settings		
					Cut Speed	Voltage	Cut Speed	Voltage	
in	in	in	%	seconds	ipm	Volts	ipm	Volts	
16 GA	0.06	0.15	250	0.1	260	123	294	121	
10 GA					190	125	224	123	
3/16				0.2	140	126	168	125	
1/4					0.5	90	127	116	127
3/8						45	130	62	129
1/2		0.18	300	1.2	30	135	40	132	
5/8		0.24	400	2.0	23	138	26	136	
3/4		Edge Start				15	141	19	141
7/8						12	143	14	143
1						8	145	10	145

OPERATION

65 A Shielded Stainless Steel

Metric

Material Thickness	Torch-to-Work Distance	Initial Pierce Height		Pierce Delay Time	Best Quality Settings		Production Settings	
					Cut Speed	Voltage	Cut Speed	Voltage
mm	mm	mm	%	seconds	mm/min	Volts	mm/min	Volts
2	1.5	3.8	250	0.1	8100	125	10000	121
3				0.2	6700	125	8260	123
4				0.5	5200	125	6150	124
6					2450	126	2850	126
8				0.7	1500	129	1860	129
10		4.5	300		960	132	1250	132
12					750	135	920	134
16		Edge Start			500	139	500	139
20					300	143	370	143

English

Material Thickness	Torch-to-Work Distance	Initial Pierce Height		Pierce Delay Time	Best Quality Settings		Production Settings		
					Cut Speed	Voltage	Cut Speed	Voltage	
in	in	in	%	seconds	ipm	Volts	ipm	Volts	
16 GA	0.06	0.15	250	0.1	345	124	426	121	
10 GA					240	125	296	123	
3/16				0.2	155	126	168	125	
1/4					0.5	80	126	96	126
3/8						40	131	52	131
1/2		0.18	300	1.2	26	136	32	135	
5/8					Edge Start			20	139
3/4		14	142	15				142	

**65 A Shielded
Aluminum**

Metric

Material Thickness	Torch-to-Work Distance	Initial Pierce Height		Pierce Delay Time	Best Quality Settings		Production Settings	
					Cut Speed	Voltage	Cut Speed	Voltage
mm	mm	mm	%	seconds	mm/min	Volts	mm/min	Volts
2	1.5	3.8	250	0.1	8800	121	10300	122
3				0.2	7400	124	8800	124
4				0.5	6000	126	7350	125
6					3200	130	4400	128
8				0.7	1950	133	2750	130
10		4.5	300		1200	136	1650	132
12					1000	138	1330	136
16		Edge Start			650	143	800	141
20		Edge Start			380	147	560	145

English

Material Thickness	Torch-to-Work Distance	Initial Pierce Height		Pierce Delay Time	Best Quality Settings		Production Settings	
					Cut Speed	Voltage	Cut Speed	Voltage
in	in	in	%	seconds	ipm	Volts	ipm	Volts
1/16	0.06	0.15	250	0.1	365	121	428	121
1/8					280	124	336	124
1/4				0.5	105	131	152	128
3/8					50	135	68	131
1/2				0.18	300	1.2	35	139
5/8		Edge Start			26	143	32	141
3/4		Edge Start			16	146	24	144

OPERATION

60 amp mechanized shielded cutting for Powermax1000/1250/1650

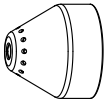

220817
Shield

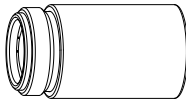

220854
Retaining cap



220819
Nozzle

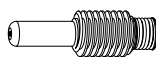

220842
Electrode

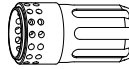

220857
Swirl ring

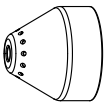
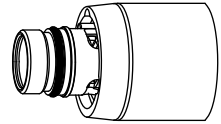

220817
Shield

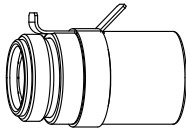

220953
Ohmic-sensing
retaining cap



220819
Nozzle

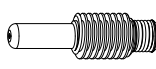

220842
Electrode

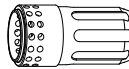

220857
Swirl ring

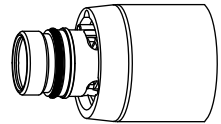

- Recommended cut speeds are a good starting point for finding the best quality cut (best angle, least dross, and best cut-surface finish). Adjust the speed for your application and table to obtain the desired cut quality.
- Maximum cut speeds are the fastest speeds possible to cut material without regard to cut quality.

Note: Torch-to-work distance for the following cut chart is 1/16 in (1.5 mm) for all cuts.

Mild steel

Arc current	Arc voltage	Pierce delay	Material thickness		Recommended cut speed		Maximum cut speed	
			in	mm	ipm	mm/min	ipm	mm/min
60	134	0	16 Ga	1.5	502	12751	627	15926
	134		10 Ga	3.4	211	5359	264	6706
	138	0.25	1/4	6.4	86	2184	132	3353
	141	0.75	3/8	9.5	41	1041	63	1600
	141	1.50	1/2	12.7	27	686	42	1067
	147		5/8	15.9	20	512	31	787
	153		3/4	19.0	14	363	22	559

Stainless steel

Arc current	Arc voltage	Pierce delay	Material thickness		Recommended cut speed		Maximum cut speed	
			in	mm	ipm	mm/min	ipm	mm/min
60	134	0	16 Ga	1.5	406	10312	625	15875
	136	0.25	10 Ga	3.4	159	4039	244	6198
	139	0.50	1/4	6.4	72	1829	110	2794
	145	0.75	3/8	9.5	34	864	53	1346
	146	2.00	1/2	12.7	23	584	35	889
	149		5/8	15.9	17	429	26	660
	154		3/4	19.0	12	297	18	457

Aluminum

Arc current	Arc voltage	Pierce delay	Material thickness		Recommended cut speed		Maximum cut speed	
			in	mm	ipm	mm/min	ipm	mm/min
60	135	0	1/16	1.6	433	10995	666	16916
	138	0.25	1/8	3.2	260	6604	400	10160
	141		1/4	6.4	94	2388	145	3683
	146	0.75	3/8	9.5	48	1219	74	1880
	149	1.50	1/2	12.7	30	762	51	1295
	153		5/8	15.9	21	545	33	838

OPERATION

45 amp mechanized shielded cutting for Powermax1000/1250/1650

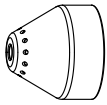

220817
Shield

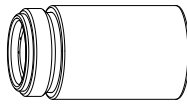

220854
Retaining cap



220941
Nozzle

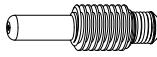

220842
Electrode

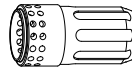

220857
Swirl ring

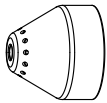
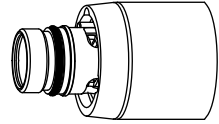

220817
Shield

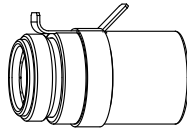

220953
Ohmic-sensing
retaining cap



220941
Nozzle

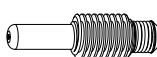

220842
Electrode

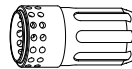

220857
Swirl ring

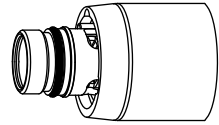

- Best Quality Settings (cut speed and voltage) — Settings that provide the starting point for finding the best cut quality (best angle, least dross, best cut-surface finish). Adjust the speed for your application and table to obtain the desired result.
- Production Settings (cut speed and voltage) — 80% of the maximum speed ratings. These speeds result in the greatest number of cut parts, but not necessarily the best possible cut quality.

**45 A Shielded
Mild Steel**

Metric

Material Thickness	Torch-to-Work Distance	Initial Pierce Height		Pierce Delay Time	Best Quality Settings		Production Settings	
					Cut Speed	Voltage	Cut Speed	Voltage
mm	mm	mm	%	seconds	mm/min	Volts	mm/min	Volts
0.5	1.5	3.8	250	0.0	9000	128	12500	126
1					9000	128	10800	128
1.5				0.1	9000	130	10200	129
2					6600	130	7800	129
3				0.4	3850	133	4900	131
4					2200	134	3560	131
6				0.5	1350	137	2050	132

English

Material Thickness	Torch-to-Work Distance	Initial Pierce Height		Pierce Delay Time	Best Quality Settings		Production Settings	
					Cut Speed	Voltage	Cut Speed	Voltage
in	in	in	%	seconds	ipm	Volts	ipm	Volts
26 GA	0.02	0.08	400	0.0	350	128	500	128
22 GA					350	128	450	128
18 GA				0.1	350	129	400	128
16 GA					350	130	400	129
14 GA	0.06	0.15	250	0.2	270	130	320	129
12 GA				0.4	190	133	216	131
10 GA					100	134	164	131
3/16				0.5	70	135	108	132
1/4				0.6	48	137	73	132

OPERATION

45 A Shielded Stainless Steel

Metric

Material Thickness	Torch-to-Work Distance	Initial Pierce Height		Pierce Delay Time	Best Quality Settings		Production Settings	
					Cut Speed	Voltage	Cut Speed	Voltage
mm	mm	mm	%	seconds	mm/min	Volts	mm/min	Volts
0.5	1.5	3.8	250	0.0	9000	130	12500	129
1					9000	130	10800	130
1.5				9000	130	10200	130	
2				6000	132	8660	131	
3				0.4	3100	132	4400	132
4					2000	134	2600	134
6				0.5	900	140	1020	139

English

Material Thickness	Torch-to-Work Distance	Initial Pierce Height		Pierce Delay Time	Best Quality Settings		Production Settings	
					Cut Speed	Voltage	Cut Speed	Voltage
in	in	in	%	seconds	ipm	Volts	ipm	Volts
26 GA	0.02	0.08	400	0.0	350	130	500	129
22 GA					350	130	450	129
18 GA				0.1	350	130	400	130
16 GA					350	130	400	130
14 GA	0.06	0.15	250	0.2	250	132	360	131
12 GA				0.4	140	132	206	131
10 GA					100	133	134	134
3/16				0.5	52	135	58	135
1/4				0.6	30	141	35	140

**45 A Shielded
Aluminum**

Metric

Material Thickness	Torch-to-Work Distance	Initial Pierce Height		Pierce Delay Time	Best Quality Settings		Production Settings	
					Cut Speed	Voltage	Cut Speed	Voltage
mm	mm	mm	%	seconds	mm/min	Volts	mm/min	Volts
1	1.5	3.8	250	0.0	8250	136	11000	136
2				0.1	6600	136	9200	135
3				0.2	3100	139	6250	134
4				0.4	2200	141	4850	135
6				0.5	1500	142	2800	137

English

Material Thickness	Torch-to-Work Distance	Initial Pierce Height		Pierce Delay Time	Best Quality Settings		Production Settings	
					Cut Speed	Voltage	Cut Speed	Voltage
in	in	in	%	seconds	ipm	Volts	ipm	Volts
1/32	0.06	0.15	250	0.0	325	136	450	136
1/16				0.1	325	136	400	136
3/32				0.2	200	136	328	134
1/8				0.4	100	140	224	134
1/4				0.5	54	142	96	137

OPERATION

100 amp mechanized unshielded cutting for Powermax1650

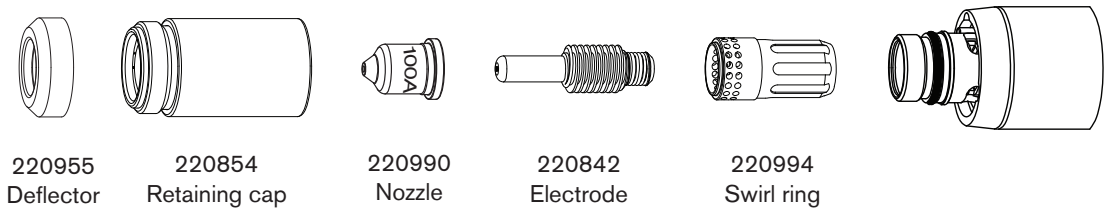

- Recommended cut speeds are a good starting point for finding the best quality cut (best angle, least dross, and best cut-surface finish). Adjust the speed for your application and table to obtain the desired cut quality.
- Maximum cut speeds are the fastest speeds possible to cut material without regard to cut quality.

Note: Torch-to-work distance for the following cut chart is 3/16 in (4.8 mm) for all cuts.

Mild steel

Arc current	Arc voltage	Pierce delay	Material thickness		Recommended cut speed		Maximum cut speed	
			in	mm	ipm	mm/min	ipm	mm/min
100	136	0.5	1/4	6.4	137	3479	210	5334
	139	0.5	3/8	9.5	79	2006	122	3098
	142	1.0	1/2	12.7	59	1498	91	2311
	146	1.0	5/8	15.9	37	939	57	1447
	150	1.5	3/4	19.0	28	711	43	1092
	155	NA	1	25.4	17	431	26	660
	160		1 1/4	31.8	10	254	16	406

Stainless steel

Arc current	Arc voltage	Pierce delay	Material thickness		Recommended cut speed		Maximum cut speed	
			in	mm	ipm	mm/min	ipm	mm/min
100	136	0.5	1/4	6.4	157	3987	241	6121
	139	0.5	3/8	9.5	85	2159	131	3327
	142	1.0	1/2	12.7	53	1346	81	2057
	146	1.0	5/8	15.9	33	838	51	1295
	150	1.5	3/4	19.0	22	558	33	838
	155	NA	1	25.4	14	355	22	558
	161		1 1/4	31.8	7	177	11	279

Aluminum

Arc current	Arc voltage	Pierce delay	Material thickness		Recommended cut speed		Maximum cut speed	
			in	mm	ipm	mm/min	ipm	mm/min
100	137	0.5	1/4	6.4	166	4216	255	6477
	139	0.5	3/8	9.5	99	2514	153	3886
	142	1.0	1/2	12.7	70	1778	107	2717
	147	1.0	5/8	15.9	50	1270	77	1955
	150	1.5	3/4	19.0	33	838	51	1295
	154	NA	1	25.4	20	508	31	787

OPERATION

85 amp mechanized unshielded cutting for Powermax1650

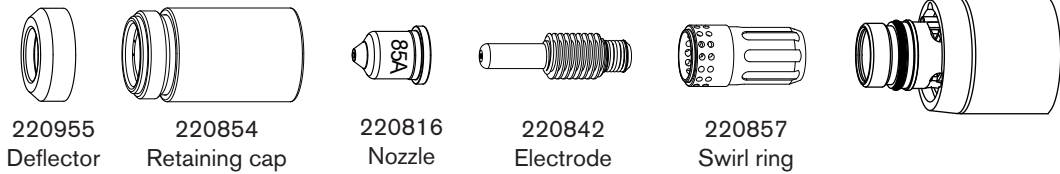

- **Best Quality Settings** (cut speed and voltage) — Settings that provide the starting point for finding the best cut quality (best angle, least dross, best cut-surface finish). Adjust the speed for your application and table to obtain the desired result.
- **Production Settings** (cut speed and voltage) — 80% of the maximum speed ratings. These speeds result in the greatest number of cut parts, but not necessarily the best possible cut quality.

**85 A Unshielded
Mild Steel**

Metric

Material Thickness	Torch-to-Work Distance	Initial Pierce Height		Pierce Delay Time	Best Quality Settings		Production Settings	
					Cut Speed	Voltage	Cut Speed	Voltage
mm	mm	mm	%	seconds	mm/min	Volts	mm/min	Volts
2	2.0	5.0	250	0.0	7150	117	10400	116
3				0.1	6240	118	9000	117
4				0.2	5250	118	7200	117
6				0.5	3450	120	4400	119
8					2400	121	3100	121
10		1560	123	2070	122			
12		6.0	300	0.7	1200	126	1600	124
16		Edge Start			820	132	930	128
20					540	137	640	132
25					320	143	400	137

English

Material Thickness	Torch-to-Work Distance	Initial Pierce Height		Pierce Delay Time	Best Quality Settings		Production Settings	
					Cut Speed	Voltage	Cut Speed	Voltage
in	in	in	%	seconds	ipm	Volts	ipm	Volts
14 GA	0.08	0.20	250	0.1	280	117	416	116
10 GA				0.2	230	118	328	117
3/16					175	119	220	118
1/4				0.5	125	120	160	119
3/8					65	122	86	122
1/2		0.24	300	0.6	42	127	56	125
5/8		Edge Start			33	131	37	128
3/4					23	136	27	131
7/8					18	140	21	134
1					12	144	15	138

OPERATION

85 A Unshielded Stainless Steel

Metric

Material Thickness	Torch-to-Work Distance	Initial Pierce Height		Pierce Delay Time	Best Quality Settings		Production Settings	
					Cut Speed	Voltage	Cut Speed	Voltage
mm	mm	mm	%	seconds	mm/min	Volts	mm/min	Volts
2	2.0	5.0	250	0.1	8550	117	11300	116
3					7000	118	9660	117
4				5600	118	7800	118	
6				0.5	3400	120	4570	121
8					2250	121	2970	122
10				6.0	300	0.5	1430	123
12		0.7	1000			129	1340	128
16		Edge Start			650	134	730	133
20		Edge Start			360	138	570	137

English

Material Thickness	Torch-to-Work Distance	Initial Pierce Height		Pierce Delay Time	Best Quality Settings		Production Settings	
					Cut Speed	Voltage	Cut Speed	Voltage
in	in	in	%	seconds	ipm	Volts	ipm	Volts
14 GA	0.08	0.20	250	0.1	340	117	452	116
10 GA					0.2	250	118	352
3/16				180		119	249	119
1/4				0.5	120	120	160	121
3/8					60	122	77	123
1/2				0.24	300	0.6	35	131
5/8		Edge Start			26	134	29	133
3/4		Edge Start			17	137	24	136

**85 A Unshielded
Aluminum**

Metric

Material Thickness	Torch-to-Work Distance	Initial Pierce Height		Pierce Delay Time	Best Quality Settings		Production Settings		
					Cut Speed	Voltage	Cut Speed	Voltage	
mm	mm	mm	%	seconds	mm/min	Volts	mm/min	Volts	
2	2.0	5.0	250	0.1	8700	118	11200	118	
3					7350	120	9600	119	
4				6000	122	8100	120		
6				3300	125	4930	122		
8		6.0	300	0.5	2350	127	3250	124	
10					1800	128	2140	127	
12		Edge Start			0.7	1300	133	1720	130
16					840	139	1130	134	
20	470				144	700	138		

English

Material Thickness	Torch-to-Work Distance	Initial Pierce Height		Pierce Delay Time	Best Quality Settings		Production Settings	
					Cut Speed	Voltage	Cut Speed	Voltage
in	in	in	%	seconds	ipm	Volts	ipm	Volts
1/8	0.08	0.20	250	0.2	280	120	368	119
3/16					200	123	271	120
1/4				110	126	172	122	
3/8				75	127	88	126	
1/2		0.24	300	0.6	45	135	62	131
5/8		Edge Start			34	139	45	134
3/4					22	143	32	137

OPERATION

65 amp mechanized unshielded cutting for Powermax1250/1650

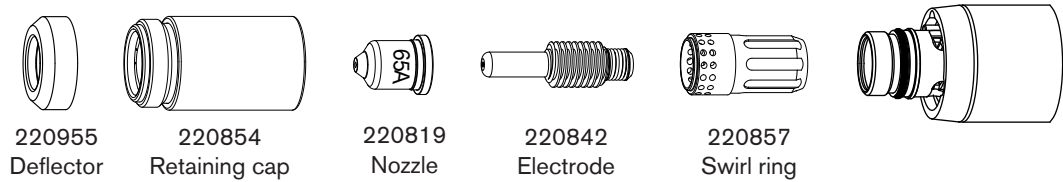

- **Best Quality Settings** (cut speed and voltage) — Settings that provide the starting point for finding the best cut quality (best angle, least dross, best cut-surface finish). Adjust the speed for your application and table to obtain the desired result.
- **Production Settings** (cut speed and voltage) — 80% of the maximum speed ratings. These speeds result in the greatest number of cut parts, but not necessarily the best possible cut quality.

**65 A Unshielded
Mild Steel**

Metric

Material Thickness	Torch-to-Work Distance	Initial Pierce Height		Pierce Delay Time	Best Quality Settings		Production Settings	
					Cut Speed	Voltage	Cut Speed	Voltage
mm	mm	mm	%	seconds	mm/min	Volts	mm/min	Volts
2	2.0	5.0	250	0.1	6050	117	7340	117
3				0.2	5200	118	6330	118
4				0.5	4250	118	5250	118
6					2550	120	3560	120
8					1620	123	2230	121
10		6.0	300	0.7	970	127	1500	122
12		Edge Start			760	129	1140	124
16					500	134	650	129
20					280	138	400	133

English

Material Thickness	Torch-to-Work Distance	Initial Pierce Height		Pierce Delay Time	Best Quality Settings		Production Settings	
					Cut Speed	Voltage	Cut Speed	Voltage
in	in	in	%	seconds	ipm	Volts	ipm	Volts
16 GA	0.08	0.20	250	0.1	255	116	308	117
10 GA					190	118	232	118
3/16					135	119	172	119
1/4				0.5	90	120	116	120
3/8					0.24	300	0.7	40
1/2		Edge Start			27	130	40	125
5/8					20	134	26	129
3/4					13	137	18	132

OPERATION

65 A Unshielded Stainless Steel

Metric

Material Thickness	Torch-to-Work Distance	Initial Pierce Height		Pierce Delay Time	Best Quality Settings		Production Settings	
					Cut Speed	Voltage	Cut Speed	Voltage
mm	mm	mm	%	seconds	mm/min	Volts	mm/min	Volts
2	2.0	5.0	250	0.1	7950	117	10300	116
3				0.2	6600	118	8500	117
4				0.5	5050	119	6500	119
6					2300	121	3070	121
8				0.7	1400	123	1900	122
10		6.0	300	0.7	920	126	1250	123
12		Edge Start			710	130	925	127
16		Edge Start			430	135	500	133

English

Material Thickness	Torch-to-Work Distance	Initial Pierce Height		Pierce Delay Time	Best Quality Settings		Production Settings	
					Cut Speed	Voltage	Cut Speed	Voltage
in	in	in	%	seconds	ipm	Volts	ipm	Volts
16 GA	0.08	0.20	250	0.1	340	116	437	115
10 GA					235	118	304	118
3/16				0.2	150	120	194	120
1/4				0.5	75	121	100	121
3/8		0.24	300	0.7	38	125	52	122
1/2		Edge Start			25	132	32	129
5/8		Edge Start			17	135	20	133

**65 A Unshielded
Aluminum**

Metric

Material Thickness	Torch-to-Work Distance	Initial Pierce Height		Pierce Delay Time	Best Quality Settings		Production Settings	
					Cut Speed	Voltage	Cut Speed	Voltage
mm	mm	mm	%	seconds	mm/min	Volts	mm/min	Volts
2	2.0	5.0	250	0.1	7750	123	11300	122
3				0.2	6550	124	9500	123
4				0.5	5400	125	7640	124
6					3000	127	3900	126
8				0.7	1800	130	2460	127
10		6.0	300	0.7	1100	133	1640	129
12		Edge Start			900	135	1250	133
16		Edge Start			600	139	700	136

English

Material Thickness	Torch-to-Work Distance	Initial Pierce Height		Pierce Delay Time	Best Quality Settings		Production Settings	
					Cut Speed	Voltage	Cut Speed	Voltage
in	in	in	%	seconds	ipm	Volts	ipm	Volts
1/16	0.08	0.20	250	0.1	325	122	476	122
1/8					250	124	360	123
3/16					175	125	245	124
1/4				0.5	100	127	128	126
3/8		0.24	300		0.7	45	132	68
1/2		Edge Start			32	136	44	134
5/8		Edge Start			24	138	28	136

OPERATION

45 amp mechanized unshielded cutting for Powermax1000/1250/1650

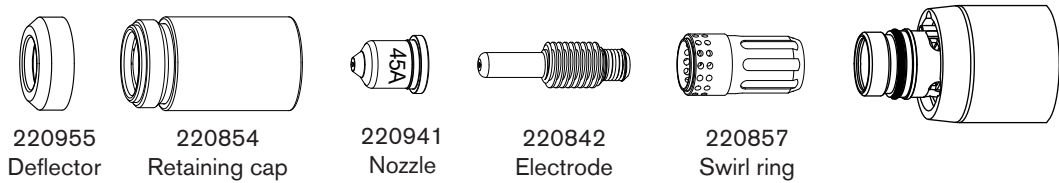

- Best Quality Settings (cut speed and voltage) — Settings that provide the starting point for finding the best cut quality (best angle, least dross, best cut-surface finish). Adjust the speed for your application and table to obtain the desired result.
- Production Settings (cut speed and voltage) — 80% of the maximum speed ratings. These speeds result in the greatest number of cut parts, but not necessarily the best possible cut quality.

**45 A Unshielded
Mild Steel**

Metric

Material Thickness	Torch-to-Work Distance	Initial Pierce Height		Pierce Delay Time	Best Quality Settings		Production Settings	
					Cut Speed	Voltage	Cut Speed	Voltage
mm	mm	mm	%	seconds	mm/min	Volts	mm/min	Volts
0.5	1.5	3.8	250	0.0	9000	120	12500	120
1					9000	120	10800	121
1.5				7700	120	10200	121	
2				6150	119	7800	122	
3				0.4	3950	121	4900	123
					2350	123	3560	124
4				0.5	1400	126	2050	124
6								

English

Material Thickness	Torch-to-Work Distance	Initial Pierce Height		Pierce Delay Time	Best Quality Settings		Production Settings	
					Cut Speed	Voltage	Cut Speed	Voltage
in	in	in	%	seconds	ipm	Volts	ipm	Volts
26 GA	0.06	0.15	250	0.0	350	120	500	120
22 GA					350	120	450	120
18 GA				0.1	350	119	400	121
16 GA					300	121	400	121
14 GA				250	119	320	122	
12 GA				0.4	200	120	216	123
10 GA					100	123	164	124
3/16				0.5	85	122	108	124
1/4								

OPERATION

45 A Unshielded Stainless Steel

Metric

Material Thickness	Torch-to-Work Distance	Initial Pierce Height		Pierce Delay Time	Best Quality Settings		Production Settings	
					Cut Speed	Voltage	Cut Speed	Voltage
mm	mm	mm	%	seconds	mm/min	Volts	mm/min	Volts
0.5	1.5	3.8	250	0.0	9000	121	12500	119
1					9000	121	10800	119
1.5				0.1	9000	121	10200	120
2					6000	122	9600	120
3				0.4	3250	123	4750	120
4					1900	128	3000	122
6				0.5	700	130	1450	124

English

Material Thickness	Torch-to-Work Distance	Initial Pierce Height		Pierce Delay Time	Best Quality Settings		Production Settings	
					Cut Speed	Voltage	Cut Speed	Voltage
in	in	in	%	seconds	ipm	Volts	ipm	Volts
26 GA	0.02	0.08	400	0.0	350	120	500	119
22 GA					350	120	450	119
18 GA				0.1	350	118	400	119
16 GA					350	121	400	120
14 GA	0.06	0.15	250	0.2	300	122	400	120
12 GA				0.4	150	121	224	120
10 GA					100	125	140	121
3/16				0.5	42	131	88	123
1/4				0.6	25	130	48	124

**45 A Unshielded
Aluminum**

Metric

Material Thickness	Torch-to-Work Distance	Initial Pierce Height		Pierce Delay Time	Best Quality Settings		Production Settings	
					Cut Speed	Voltage	Cut Speed	Voltage
mm	mm	mm	%	seconds	mm/min	Volts	mm/min	Volts
1	1.5	3.8	250	0.0	7400	126	11000	121
2				0.1	4400	127	9200	123
3				0.2	2800	129	6250	125
4				0.4	2100	132	4700	126
6				0.5	1050	135	2250	127

English

Material Thickness	Torch-to-Work Distance	Initial Pierce Height		Pierce Delay Time	Best Quality Settings		Production Settings	
					Cut Speed	Voltage	Cut Speed	Voltage
in	in	in	%	seconds	ipm	Volts	ipm	Volts
1/32	0.06	0.15	250	0.0	325	126	450	121
1/16				0.1	200	126	400	122
3/32				0.2	150	127	328	124
1/8				0.4	100	130	224	125
1/4				0.5	36	136	72	127

OPERATION

FineCut® consumables for Powermax1000/1250/1650

Note: The cut charts in this section apply to both shielded and unshielded consumables

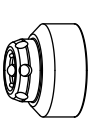

220948
Shield

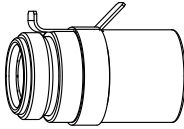

220953
Retaining cap



220930
Nozzle

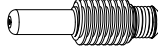

220842
Electrode

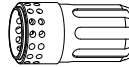

220857
Swirl ring

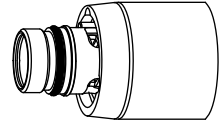

220955
Deflector

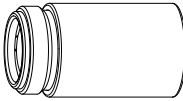

220854
Retaining cap



220930
Nozzle

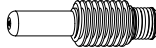

220842
Electrode

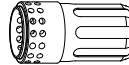

220857
Swirl ring

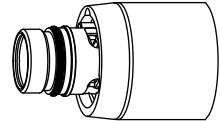

- Best Quality Settings (cut speed and voltage) — Settings that provide the starting point for finding the best cut quality (best angle, least dross, best cut-surface finish). Adjust the speed for your application and table to obtain the desired result.

**FineCut
Mild Steel**

Metric

Material Thickness	Amps	Torch-to-Work Distance	Initial Pierce Height		Pierce Delay Time	Best Quality Settings		
						Cut Speed	Voltage	
mm	A	mm	mm	%	seconds	mm/min	Volts	
0.5	40	1.5	3.8	250	0.0	8250	78	
0.6						8250	78	
0.8						8250	78	
1	45				0.1	8250	78	
1.5						0.2	6400	78
2							5250	82
3						0.4	2750	83
4							1900	84

English

Material Thickness	Amps	Torch-to-Work Distance	Initial Pierce Height		Pierce Delay Time	Best Quality Settings		
						Cut Speed	Voltage	
	A	in	in	%	seconds	ipm	Volts	
26 GA	40	0.06	0.15	250	0.0	325	78	
24 GA						325	78	
22 GA					0.1	325	78	
20 GA						325	78	
18 GA	45				0.2	325	78	
16 GA						0.4	250	78
14 GA							220	82
12 GA						0.5	120	83
10 GA		95	84					

OPERATION

FineCut

Stainless Steel

Metric

Material Thickness	Amps	Torch-to-Work Distance	Initial Pierce Height		Pierce Delay Time	Best Quality Settings	
						Cut Speed	Voltage
mm	A	mm	mm	%	seconds	mm/min	Volts
0.5	40	0.5	2.0	400	0.0	8250	68
0.6						8250	68
0.8					0.1	8250	68
1	8250					68	
1.5	45				0.4	6150	70
2						4800	71
3					0.5	2550	81
4						1050	84

English

Material Thickness	Amps	Torch-to-Work Distance	Initial Pierce Height		Pierce Delay Time	Best Quality Settings	
						Cut Speed	Voltage
	A	in	in	%	seconds	ipm	Volts
26 GA	40	0.02	0.08	400	0.0	325	68
24 GA						325	68
22 GA					0.1	325	68
20 GA						325	68
18 GA	45				0.2	325	68
16 GA						0.4	240
14 GA					200		70
12 GA					0.5		120
10 GA		75	83				

Using the hand torch



WARNING
INSTANT-ON TORCHES
PLASMA ARC CAN CAUSE INJURY AND BURNS

Plasma arc comes on immediately when the torch trigger is activated.

The plasma arc will cut quickly through gloves and skin.

- Wear correct and appropriate protective equipment.
- Keep away from the torch tip.
- Do not hold the workpiece and keep your hands clear of the cutting path.
- Never point the torch toward yourself or others.

Operate the safety trigger

The hand torches are equipped with a safety trigger to prevent accidental firings. When you are ready to use the torch, flip the trigger's safety cover forward (toward the torch head) and press the red torch trigger as show below.

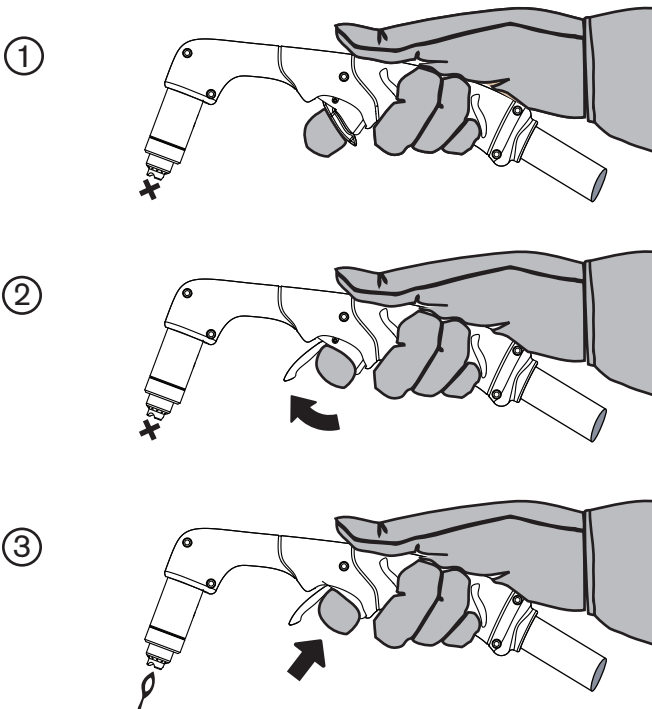

Hand torch cutting hints

- Drag the torch tip lightly along the workpiece to maintain a steady cut.
- While cutting, make sure that sparks exit from the bottom of the workpiece. The sparks should lag slightly behind the torch as you cut (15° — 30° angle from vertical).
- If sparks spray up from the workpiece, move the torch more slowly, or set the output current higher.

- With hand torches, hold the torch nozzle perpendicular to the workpiece so that the nozzle is at a 90° angle to the cutting surface. Observe the cutting arc as the torch cuts.

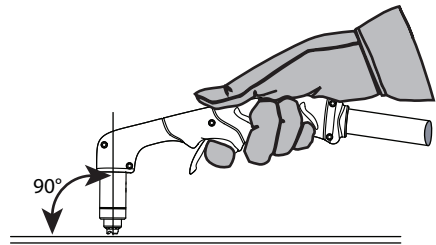

- If you fire the torch unnecessarily, you will shorten the life of the nozzle and electrode.

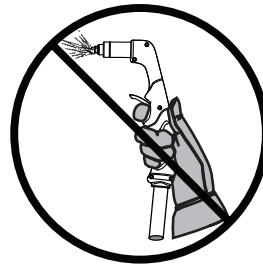

- Pulling, or dragging, the torch along the cut is easier than pushing the torch.
- For straight-line cuts, use a straight edge as a guide. To cut circles, use a template or a radius cutter attachment (a circle cutting guide). See Section 4, *Maintenance and Parts*, for part numbers for the Hypertherm plasma cutting guides for cutting circles and making bevel cuts.

Start a cut from the edge of the workpiece

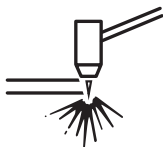

1. With the work clamp attached to the workpiece, hold the torch nozzle perpendicular (90°) to the edge of the workpiece.



2. Press the torch's trigger to start the arc. Pause at the edge until the arc has cut completely through the workpiece.



3. Drag the torch tip lightly across the workpiece to proceed with the cut. Maintain a steady, even pace.



OPERATION

Pierce a workpiece

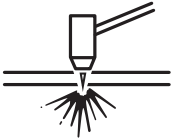

WARNING

SPARKS AND HOT METAL CAN INJURE EYES AND BURN SKIN. When firing the torch at an angle, sparks and hot metal will spray out from the nozzle. Point the torch away from yourself and others.

1. With the work clamp attached to the workpiece, hold the torch at an approximate 30° angle to the workpiece with the torch tip within 1/16 inch (1.5 mm) of the workpiece before firing the torch.



2. Fire the torch while still at an angle to the workpiece. Slowly rotate the torch to a perpendicular (90°) position.



3. Hold the torch in place while continuing to press the trigger. When sparks exit below the workpiece, the arc has pierced the material.
4. When the pierce is complete, drag the nozzle lightly along the workpiece to proceed with the cut.



Gouge a workpiece

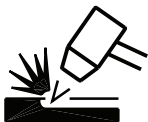

WARNING

SPARKS AND HOT METAL CAN INJURE EYES AND BURN SKIN.
 When firing the torch at an angle, sparks and hot metal will spray out from the nozzle. Point the torch away from yourself and others.

1. Hold the torch so that the torch tip is within 1/16 inch (1.5 mm) from the workpiece before firing the torch.

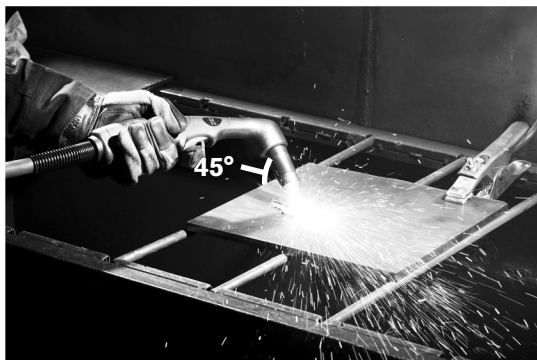

2. Hold the torch at a 45° angle to the workpiece with a small gap between the torch tip and the workpiece. Press the trigger to obtain a pilot arc. Transfer the arc to the work piece.



3. Maintain an approximate 45° angle to the workpiece as you feed into the gouge. Push the plasma arc in the direction of the gouge you want to create. Keep a small distance between the torch tip and the molten metal to avoid reducing consumable life or damaging the torch.

Changing the torch's angle changes the dimensions of the gouge.

OPERATION

Gouge profile

You can vary the gouge profile by varying the speed of the torch over the workpiece, varying the torch-to-work standoff distance, varying the angle of the torch to the workpiece, and varying the current output of the power supply.

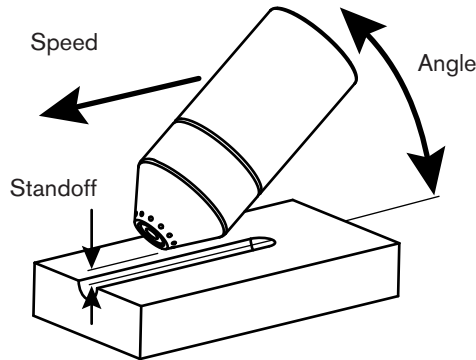

Typical Gouge Profile for 60A / 65A Operation

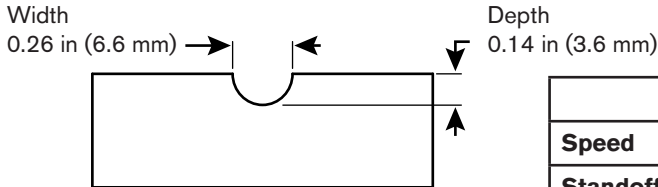

Operating parameters	
Speed	20-25 ipm (50.8-63.5 cm/min)
Standoff	1/4-3/8 in (6.4-9.5 mm)
Angle	35-40°

Typical Gouge Profile for 80A / 85A Operation

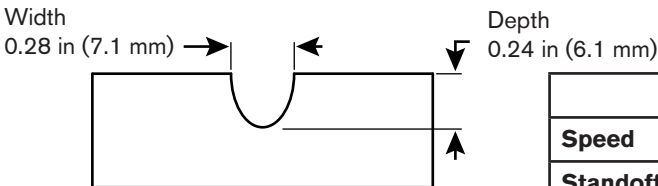

Operating parameters	
Speed	20-25 ipm (50.8-63.5 cm/min)
Standoff	1/4-3/8 in (6.4-9.5 mm)
Angle	35-40°

Typical Gouge Profile for 100 A Operation

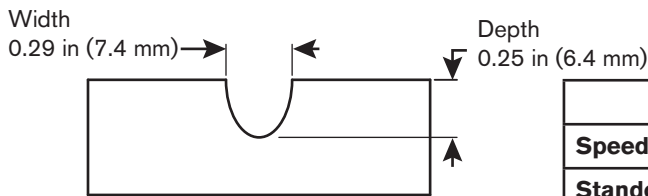

Operating parameters	
Speed	20-25 ipm (50.8-63.5 cm/min)
Standoff	1/4-3/8 in (6.4-9.5 mm)
Angle	35-40°

Varying the gouge profile

The following actions have the stated effects on the gouge profile:

- **Increasing the speed** of the torch will **decrease width** and **decrease depth**.
- **Decreasing the speed** of the torch will **increase width** and **increase depth**.
- **Increasing the standoff** of the torch will **increase width** and **decrease depth**.
- **Decreasing the standoff** of the torch will **decrease width** and **increase depth**.
- **Increasing the angle** of the torch (more vertical) will **decrease width** and **increase depth**.
- **Decreasing the angle** of the torch (less vertical) will **increase width** and **decrease depth**.
- **Increasing the current** of the power supply will **increase width** and **increase depth**.
- **Decreasing the current** of the power supply will **decrease width** and **decrease depth**.

Common hand-cutting faults

The torch does not cut completely through the workpiece. The causes can be:

- The cut speed is too fast.
- The consumables are worn.
- The metal being cut is too thick for the selected amperage.
- Gouging consumables are installed instead of drag-cutting consumables.
- The work clamp is not attached properly to the workpiece.
- The gas pressure or gas flow rate is too low.

Cut quality is poor. The causes can be:

- The metal being cut is too thick for the amperage.
- The wrong consumables are being used (gouging consumables are installed instead of drag-cutting consumables, for example).
- You are moving the torch too quickly or too slowly.

The arc sputters and consumables life is shorter than expected. The cause can be:

- Moisture in the gas supply.
- Incorrect gas pressure.
- Consumables incorrectly installed.

Using the machine torch

Since the Powermax with a machine torch can be used with a wide variety of cutting tables, track burners, pipe bevelers, and so on, you will need to refer to the manufacturer's instructions for specifics on operating the machine torch in your configuration. However, the information in the following sections will help you optimize cut quality and maximize consumable life.

Ensure the torch and table are set up correctly

- Use a square to align the torch at right angles to the workpiece in two dimensions.
- The torch may travel more smoothly if you clean, check and "tune" the cutting table's rails and drive system. Unsteady machine motion can cause a regular, wavy pattern on the cut surface.
- Ensure that the torch does not touch the workpiece during cutting. Contact with the workpiece can damage the shield and nozzle and affect the cut surface.

Understand and optimize cut quality

There are several factors to consider in cut quality:

- Cut angle — The degree of angularity of the cut edge.
- Dross — The molten material that solidifies on the top or bottom of the workpiece.
- Straightness of the cut surface — The cut surface can be concave or convex.

The following sections explain how these factors can affect cut quality.

Cut or bevel angle

- A positive cut angle, or bevel, results when more material is removed from the top of the cut than from the bottom.
- A negative cut angle results when more material is removed from the bottom of the cut.

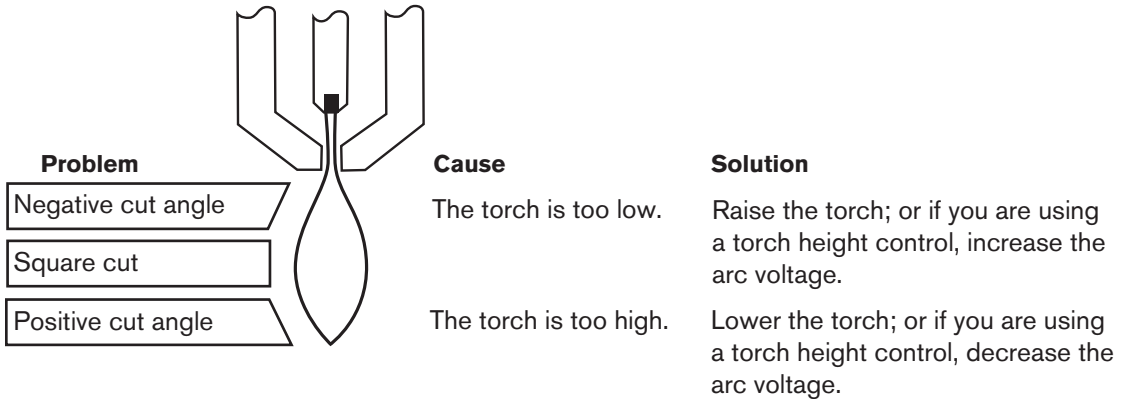

Note: The squarest cut angle will be on the *right* side with respect to the forward motion of the torch. The left side will always have some degree of bevel.

To determine whether a cut-angle problem is being caused by the plasma system or the drive system, make a test cut and measure the angle of each side. Next, rotate the torch 90° in its holder and repeat the process. If the angles are the same in both tests, the problem is in the drive system.

If a cut-angle problem persists after “mechanical causes” have been eliminated (see “Ensure the torch and table are set up correctly” on page 3-49), check the torch-to-work distance, especially if the cut angles are all positive or all negative. Also consider the material being cut: if the metal is magnetized or hardened, you are more likely to experience cut angle problems.

Dross

Some amount of dross will always be present when cutting with air plasma. However, you can minimize the amount and type of dross by adjusting your system correctly for your application.

Excess dross appears on the top edge of both pieces of the plate when the torch is too low (or voltage is too low when using a torch height control). Adjust the torch or adjust the voltage in small increments (5 volts or less) until the dross is reduced.

Low-speed dross forms when the torch’s cutting speed is too slow and the arc angles ahead. It forms as a heavy, bubbly deposit at the bottom of the cut and can be removed easily. Increase the speed to reduce this type of dross.



High-speed dross forms when the cutting speed is too fast and the arc angles behind. It forms as a thin, linear bead of solid metal attached very close to the cut. It is more firmly attached to the bottom of the cut than at low speed and is difficult to remove. To reduce high-speed dross:

- Decrease the cutting speed.
- Decrease the torch-to-work distance.

Note: Dross is more likely to form on warm or hot metal than on cool metal. For example, the first cut in a series of cuts usually produces the least dross. As the workpiece heats up, more dross can accumulate on subsequent cuts.

Worn or damaged consumables may produce excess dross.

Straightness of the cut surface

	<p>A typical plasma cut surface is slightly concave.</p> <p>The cut surface may become more concave, or convex. Correct torch height is required to keep the cut surface acceptably close to straight. Worn consumables also affect the straightness of the cut.</p>
	<p>A strongly concave cut surface occurs when the torch-to-work distance is too low. Increase the torch-to-work distance to straighten the cut surface.</p>
	<p>A convex cut surface occurs when the torch-to-work distance is too great or the cutting current is too high. First, try lowering the torch, then reduce the cutting current.</p>

To pierce a workpiece using the machine torch

As with the hand torch, you can start a cut with the machine torch at the edge of the workpiece or by piercing the workpiece. Piercing will result in a shorter consumable life than with edge starts.

The pierce delay must be sufficiently long that the arc can pierce the material before the torch moves, but not so long that the arc “wanders” while trying to find the edge of a large hole.

When piercing maximum thicknesses, the ring of dross that forms during the pierce may become high enough to contact the torch when the torch begins to move after the pierce is complete. Remove the dross if the torch will contact it during the cut.

Common machine-cutting faults

The torch's pilot arc will initiate, but will not transfer. Causes can be:

- The work cable is not making good contact with the cutting table or the cutting table is not making good contact with the workpiece.
- The torch-to-work distance is too large.

The workpiece is not totally penetrated, and there is excessive sparking on the top of the workpiece. Causes can be:

- The consumables are worn and need to be replaced. For optimized performance in a mechanized application, replace the nozzle and the electrode together.
- The work cable is not making good contact with the cutting table or the cutting table is not making good contact with the workpiece.
- The current (amperage) is set too low. See “Using the cut charts” on page 3-3 for more information.
- The cut speed is too high. See “Using the cut charts” on page 3-3 for more information.
- The metal being cut exceeds the maximum capacity for the selected amperage.

Dross forms on the bottom of the cut. Causes can be:

- The consumables are worn and need to be replaced. For optimized performance in a mechanized application, replace the nozzle and the electrode together.
- The cutting speed is not correct. See “Using the cut charts” on page 3-3 for more information.
- The current (amperage) is set too low. See “Using the cut charts” on page 3-3 for more information.

The cut angle is not square. Causes can be:

- The torch is not square to the workpiece.
- The consumables are worn and need to be replaced. For optimized performance in a mechanized application, replace the nozzle and the electrode together.
- The direction of the torch travel is incorrect. The high-quality cut is always on the right with respect to the forward motion of the torch.
- The distance between the torch and the workpiece is not correct.
- The cutting speed is not correct. See “Using the cut charts” on page 3-3 for more information.

The consumables' life is shortened. Causes can be:

- The arc current, arc voltage, travel speed, and other variables are not set as recommended in the cut charts.
- Firing the arc in the air (beginning or ending the cut off of the plate surface). Starting at the edge is acceptable as long as the arc makes contact with the workpiece when started.
- Starting a pierce with an incorrect torch height. Refer to the cut charts for the specific initial pierce height.



Section 4

MAINTENANCE AND PARTS

In this section:

Perform routine maintenance	4-2
Inspect the consumables	4-3
Hand torch replacement parts	4-4
Machine torch replacement parts	4-5
Accessory parts.....	4-6

Perform routine maintenance

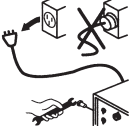
		<p>DANGER ELECTRIC SHOCK CAN KILL</p>
 <p>Disconnect the electrical power before you perform any maintenance. All work that requires removal of the power supply cover must be performed by a qualified technician.</p>		

Every use:

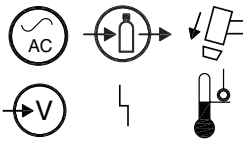

Check indicator lights and fault icons.
Correct any fault conditions.

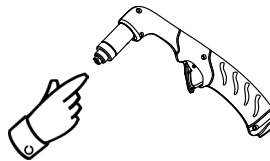

Inspect the consumables for proper installation and wear.

Every 3 months:



Replace any damaged labels.

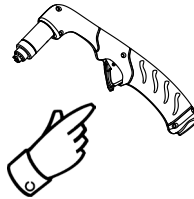

Inspect the trigger for damage. Inspect the torch body for cracks and exposed wires. Replace any damaged parts.



Inspect the power cord and plug. Replace if damaged.

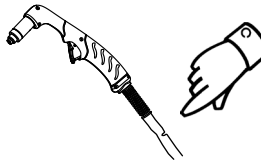



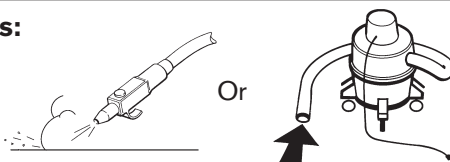

Inspect the torch lead.
Replace if damaged.

Every 6 months:

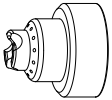

Clean the inside of the power supply with compressed air or a vacuum.

Inspect the consumables

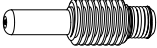
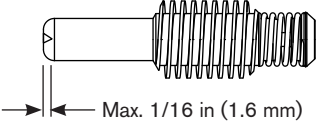
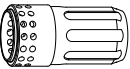
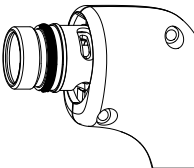
Part		Inspect	Action
	Shield or deflector	The center hole for roundness. The gap between the shield and the nozzle for accumulated debris.	Replace the shield if the hole is no longer round. Remove the shield and clean away any material.
	Nozzle	The center hole for roundness.  Good  Worn	Replace nozzle if the center hole is not round.
	Electrode	 Max. 1/16 in (1.6 mm)	Replace electrode if the surface is worn or the pit depth is greater than 1/16 inch (1.6 mm) deep.
	Swirl ring	The surface inside the swirl ring for damage or wear and the gas holes for blockages.	Replace swirl ring if the surface is damaged or worn or any of the gas holes are blocked.
	Torch o-ring	The surface for damage, wear, or a lack of lubrication.	If the o-ring is dry, lubricate it and the threads with a thin layer of silicone lubricant. If the o-ring is worn or damaged, replace it.

Hand torch replacement parts

Duramax HRT

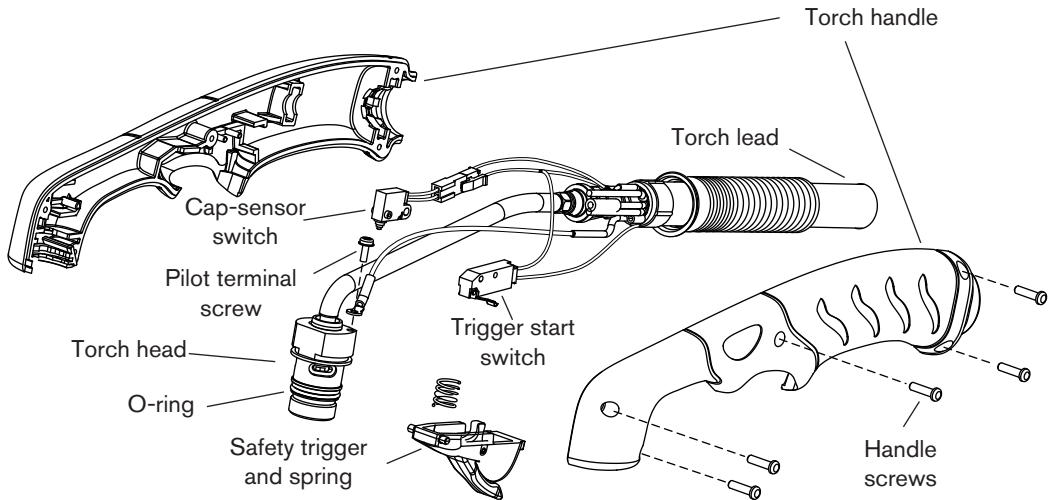

The entire hand torch and lead assembly can be replaced, or individual component parts can be replaced.

Part number	Description
005252	Trigger start switch
058519	O-ring
075504	Pilot terminal screw
075714	Handle screws, #4 x 1/2 slotted TORX pan head, S/B
228717	Kit: H65/H85/HRT Torch handle replacement
228719	Kit: H65/H85/HRT Cap-sensor switch replacement
228721	Kit: H65/H85/H65s/H85s/HRT Safety trigger with spring replacement
228784	Kit: HRT Torch lead replacement, 25 ft (7.6 m)
228785	Kit: HRT Torch lead replacement, 50 ft (15.2 m)
228788*	Kit: HRT Hand torch assembly with 25 ft (7.6 m) lead
228789*	Kit: HRT Hand torch assembly with 50 ft (15.2 m) lead
228792	Kit: HRT Torch main body replacement

* The torch assembly also includes a variety of Duramax consumables.

Machine torch replacement parts

Duramax MRT

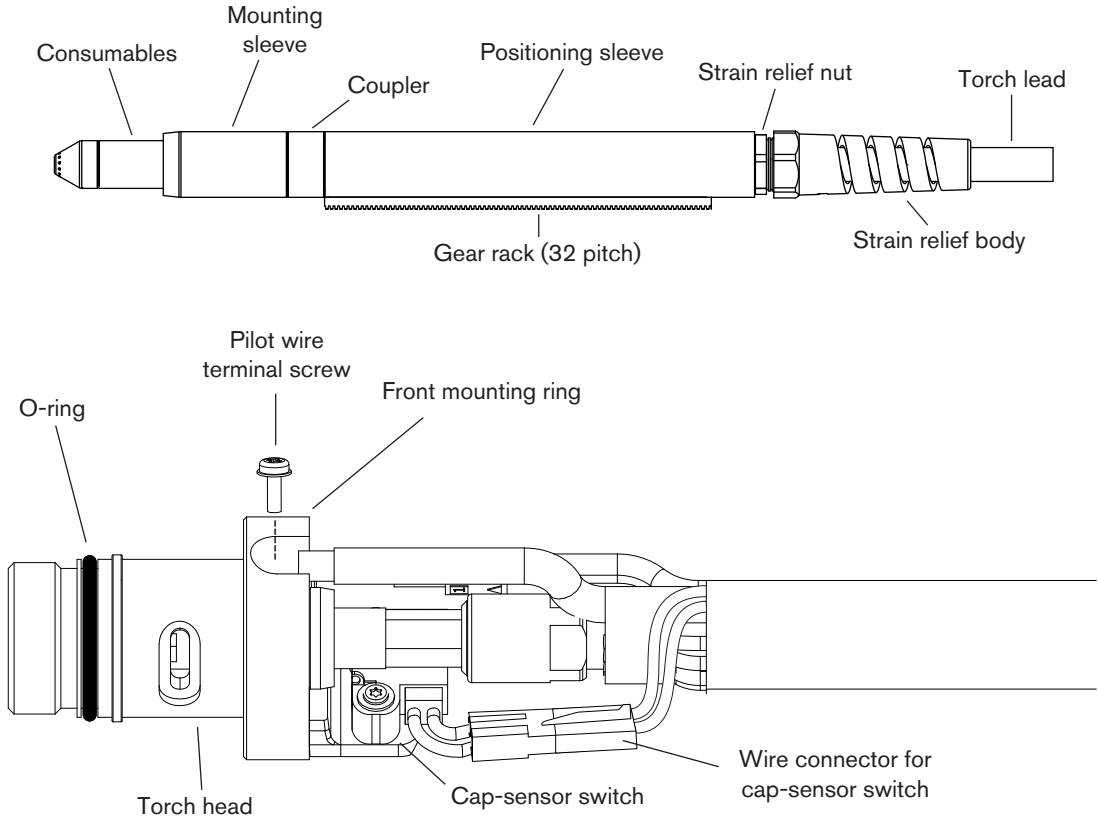

MAINTENANCE AND PARTS

The entire machine torch and lead assembly can be replaced, or individual component parts can be replaced.

Part number	Description
058519	O-ring
075504	Pilot terminal screw
228720	Kit: Cap-sensor switch replacement
228735	Kit: M65/M65m/M85/M85m/MRT front mounting sleeve
228736	Kit: M65/M65m/M85/M85m/MRT adapter ring (coupler)
228737	Kit: M65/M85/MRT positioning sleeve
228738	Kit: M65/M85/MRT removable gear rack
228786	Kit: MRT torch lead replacement, 25 ft (7.6 m)
228787	Kit: MRT torch lead replacement, 50 ft (15.2 m)
228790*	Kit: MRT Machine torch assembly with 25 ft (7.6 m) lead
228791*	Kit: MRT Machine torch assembly with 50 ft (15.2 m) lead
228793	Kit: MRT torch main body replacement

* The torch assembly also includes a variety of Duramax consumables.

Accessory parts

Part number	Description
024548	Leather torch sheathing, 25 ft (7.5 m)
127102	Basic plasma (circles and lines) cutting guide
027668	Deluxe plasma (circles and lines) cutting guide