



OM-193472AH

2016-10

Processes



MIG (GMAW) Welding

Flux Cored (FCAW) Welding

Description



Wire Feeder

22A, 24A

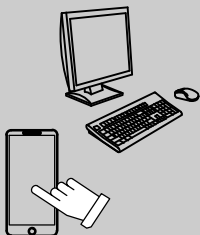
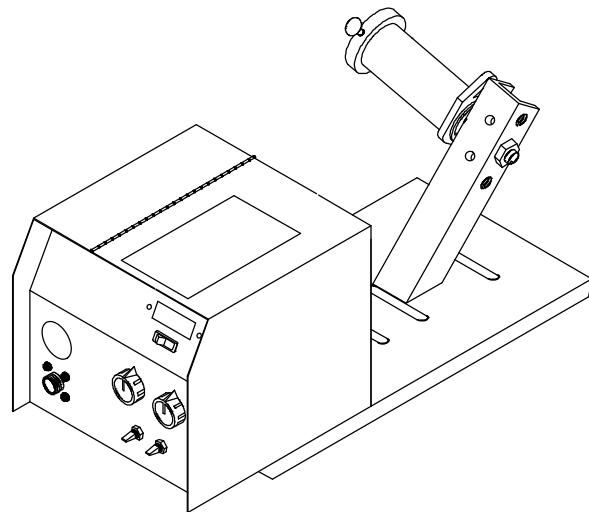

For product information,
Owner's Manual translations,
and more, visit

www.MillerWelds.com

OWNER'S MANUAL

File: MIG (GMAW)



From Miller to You

Thank you and congratulations on choosing Miller. Now you can get the job done and get it done right. We know you don't have time to do it any other way.

That's why when Niels Miller first started building arc welders in 1929, he made sure his products offered long-lasting value and superior quality. Like you, his customers couldn't afford anything less. Miller products had to be more than the best they could be. They had to be the best you could buy.

Today, the people that build and sell Miller products continue the tradition. They're just as committed to providing equipment and service that meets the high standards of quality and value established in 1929.

This Owner's Manual is designed to help you get the most out of your Miller products. Please take time to read the Safety precautions. They will help you protect yourself against potential hazards on the worksite.

We've made installation and operation quick and easy. With Miller you can count on years of reliable service with proper maintenance. And if for some reason the unit needs repair, there's a Troubleshooting section that will help you figure out what the problem is. The parts list will then help you to decide the exact part you may need to fix the problem. Warranty and service information for your particular model are also provided.



Miller is the first welding equipment manufacturer in the U.S.A. to be registered to the ISO 9001 Quality System Standard.



Miller Electric manufactures a full line of welders and welding related equipment. For information on other quality Miller products, contact your local Miller distributor to receive the latest full line catalog or individual specification sheets. **To locate your nearest distributor or service agency call 1-800-4-A-Miller, or visit us at www.MillerWelds.com on the web.**



Working as hard as you do – every power source from Miller is backed by the most hassle-free warranty in the business.



TABLE OF CONTENTS

SECTION 1 – SAFETY PRECAUTIONS - READ BEFORE USING	1
1-1. Symbol Usage	1
1-2. Arc Welding Hazards	1
1-3. Additional Symbols For Installation, Operation, And Maintenance	3
1-4. California Proposition 65 Warnings	4
1-5. Principal Safety Standards	4
1-6. EMF Information	4
SECTION 2 – CONSIGNES DE SÉCURITÉ – LIRE AVANT UTILISATION	5
2-1. Symboles utilisés	5
2-2. Dangers relatifs au soudage à l'arc	5
2-3. Dangers supplémentaires en relation avec l'installation, le fonctionnement et la maintenance	7
2-4. Proposition californienne 65 Avertissements	8
2-5. Principales normes de sécurité	8
2-6. Informations relatives aux CEM	8
SECTION 3 – DEFINITIONS	9
3-1. Additional Safety Symbols And Definitions	9
3-2. Miscellaneous Symbols And Definitions	11
SECTION 4 – SPECIFICATIONS	12
4-1. Serial Number And Rating Label Location	12
4-2. Unit Specifications	12
4-3. Environmental Specifications	12
SECTION 5 – INSTALLATION	14
5-1. Selecting A Location	14
5-2. Equipment Connection Diagrams	15
5-3. 14-Pin Plug, Shielding Gas And Optional Volt Sense Lead	15
5-4. 14-Pin Plug Information	16
5-5. Connecting Welding Gun And Weld Cable	16
5-6. Optional Meter Circuit Board Settings	17
5-7. Motor Start/Burnback Control	18
5-8. Installing Wire Guide And Drive Roll	19
5-9. Installing And Threading Welding Wire	20
SECTION 6 – OPERATION	21
6-1. Front Panel Controls	21
6-2. Optional Side Panel Controls	22
SECTION 7 – MAINTENANCE & TROUBLESHOOTING	22
7-1. Routine Maintenance	22
7-2. Overload Protection	23
7-3. Troubleshooting	23
SECTION 8 – ELECTRICAL DIAGRAM	24
SECTION 9 – PARTS LIST	26
WARRANTY	

SECTION 1 – SAFETY PRECAUTIONS - READ BEFORE USING

som 2015-09

 Protect yourself and others from injury — read, follow, and save these important safety precautions and operating instructions.

1-1. Symbol Usage



DANGER! – Indicates a hazardous situation which, if not avoided, will result in death or serious injury. The possible hazards are shown in the adjoining symbols or explained in the text.



Indicates a hazardous situation which, if not avoided, could result in death or serious injury. The possible hazards are shown in the adjoining symbols or explained in the text.

NOTICE – Indicates statements not related to personal injury.

 Indicates special instructions.



This group of symbols means Warning! Watch Out! ELECTRIC SHOCK, MOVING PARTS, and HOT PARTS hazards. Consult symbols and related instructions below for necessary actions to avoid the hazards.

1-2. Arc Welding Hazards



The symbols shown below are used throughout this manual to call attention to and identify possible hazards. When you see the symbol, watch out, and follow the related instructions to avoid the hazard. The safety information given below is only a summary of the more complete safety information found in the Safety Standards listed in Section 1-5. Read and follow all Safety Standards.



Only qualified persons should install, operate, maintain, and repair this unit.



During operation, keep everybody, especially children, away.



ELECTRIC SHOCK can kill.

Touching live electrical parts can cause fatal shocks or severe burns. The electrode and work circuit is electrically live whenever the output is on. The input power circuit and machine internal circuits are also live when power is on. In semiautomatic or automatic wire welding, the wire, wire reel, drive roll housing, and all metal parts touching the welding wire are electrically live. Incorrectly installed or improperly grounded equipment is a hazard.

- Do not touch live electrical parts.

- Wear dry, hole-free insulating gloves and body protection.
- Insulate yourself from work and ground using dry insulating mats or covers big enough to prevent any physical contact with the work or ground.
- Do not use AC output in damp areas, if movement is confined, or if there is a danger of falling.
- Use AC output ONLY if required for the welding process.
- If AC output is required, use remote output control if present on unit.
- Additional safety precautions are required when any of the following electrically hazardous conditions are present: in damp locations or while wearing wet clothing; on metal structures such as floors, gratings, or scaffolds; when in cramped positions such as sitting, kneeling, or lying; or when there is a high risk of unavoidable or accidental contact with the workpiece or ground. For these conditions, use the following equipment in order presented: 1) a semiautomatic DC constant voltage (wire) welder, 2) a DC manual (stick) welder, or 3) an AC welder with reduced open-circuit voltage. In most situations, use of a DC, constant voltage wire welder is recommended. And, do not work alone!
- Disconnect input power or stop engine before installing or servicing this equipment. Lockout/tagout input power according to OSHA 29 CFR 1910.147 (see Safety Standards).
- Properly install, ground, and operate this equipment according to its Owner's Manual and national, state, and local codes.

- Always verify the supply ground – check and be sure that input power cord ground wire is properly connected to ground terminal in disconnect box or that cord plug is connected to a properly grounded receptacle outlet.
- When making input connections, attach proper grounding conductor first – double-check connections.
- Keep cords dry, free of oil and grease, and protected from hot metal and sparks.
- Frequently inspect input power cord and ground conductor for damage or bare wiring – replace immediately if damaged – bare wiring can kill.
- Turn off all equipment when not in use.
- Do not use worn, damaged, undersized, or repaired cables.
- Do not drape cables over your body.
- If earth grounding of the workpiece is required, ground it directly with a separate cable.
- Do not touch electrode if you are in contact with the work, ground, or another electrode from a different machine.
- Do not touch electrode holders connected to two welding machines at the same time since double open-circuit voltage will be present.
- Use only well-maintained equipment. Repair or replace damaged parts at once. Maintain unit according to manual.
- Wear a safety harness if working above floor level.
- Keep all panels and covers securely in place.
- Clamp work cable with good metal-to-metal contact to workpiece or worktable as near the weld as practical.
- Insulate work clamp when not connected to workpiece to prevent contact with any metal object.
- Do not connect more than one electrode or work cable to any single weld output terminal. Disconnect cable for process not in use.
- Use GFCI protection when operating auxiliary equipment in damp or wet locations.

SIGNIFICANT DC VOLTAGE exists in inverter welding power sources AFTER removal of input power.

- Turn Off inverter, disconnect input power, and discharge input capacitors according to instructions in Maintenance Section before touching any parts.



HOT PARTS can burn.

- Do not touch hot parts bare handed.
- Allow cooling period before working on equipment.
- To handle hot parts, use proper tools and/or wear heavy, insulated welding gloves and clothing to prevent burns.



FUMES AND GASES can be hazardous.

Welding produces fumes and gases. Breathing these fumes and gases can be hazardous to your health.

- Keep your head out of the fumes. Do not breathe the fumes.
- If inside, ventilate the area and/or use local forced ventilation at the arc to remove welding fumes and gases. The recommended way to determine adequate ventilation is to sample for the composition and quantity of fumes and gases to which personnel are exposed.
- If ventilation is poor, wear an approved air-supplied respirator.
- Read and understand the Safety Data Sheets (SDSs) and the manufacturer's instructions for adhesives, coatings, cleaners, consumables, coolants, degreasers, fluxes, and metals.
- Work in a confined space only if it is well ventilated, or while wearing an air-supplied respirator. Always have a trained watch-person nearby. Welding fumes and gases can displace air and lower the oxygen level causing injury or death. Be sure the breathing air is safe.
- Do not weld in locations near degreasing, cleaning, or spraying operations. The heat and rays of the arc can react with vapors to form highly toxic and irritating gases.
- Do not weld on coated metals, such as galvanized, lead, or cadmium plated steel, unless the coating is removed from the weld area, the area is well ventilated, and while wearing an air-supplied respirator. The coatings and any metals containing these elements can give off toxic fumes if welded.



ARC RAYS can burn eyes and skin.

Arc rays from the welding process produce intense visible and invisible (ultraviolet and infrared) rays that can burn eyes and skin. Sparks fly off from the weld.

- Wear an approved welding helmet fitted with a proper shade of filter lenses to protect your face and eyes from arc rays and sparks when welding or watching (see ANSI Z49.1 and Z87.1 listed in Safety Standards).
- Wear approved safety glasses with side shields under your helmet.
- Use protective screens or barriers to protect others from flash, glare and sparks; warn others not to watch the arc.
- Wear body protection made from durable, flame-resistant material (leather, heavy cotton, wool). Body protection includes oil-free clothing such as leather gloves, heavy shirt, cuffless trousers, high shoes, and a cap.



WELDING can cause fire or explosion.

Welding on closed containers, such as tanks, drums, or pipes, can cause them to blow up. Sparks can fly off from the welding arc. The flying sparks, hot workpiece, and hot equipment can cause fires and burns. Accidental contact of electrode to metal objects can cause sparks, explosion, overheating, or fire. Check and be sure the area is safe before doing any welding.

- Remove all flammables within 35 ft (10.7 m) of the welding arc. If this is not possible, tightly cover them with approved covers.
- Do not weld where flying sparks can strike flammable material.
- Protect yourself and others from flying sparks and hot metal.
- Be alert that welding sparks and hot materials from welding can easily go through small cracks and openings to adjacent areas.
- Watch for fire, and keep a fire extinguisher nearby.
- Be aware that welding on a ceiling, floor, bulkhead, or partition can cause fire on the hidden side.
- Do not weld on containers that have held combustibles, or on closed containers such as tanks, drums, or pipes unless they are properly prepared according to AWS F4.1 and AWS A6.0 (see Safety Standards).
- Do not weld where the atmosphere can contain flammable dust, gas, or liquid vapors (such as gasoline).
- Connect work cable to the work as close to the welding area as practical to prevent welding current from traveling long, possibly unknown paths and causing electric shock, sparks, and fire hazards.
- Do not use welder to thaw frozen pipes.

- Remove stick electrode from holder or cut off welding wire at contact tip when not in use.
- Wear body protection made from durable, flame-resistant material (leather, heavy cotton, wool). Body protection includes oil-free clothing such as leather gloves, heavy shirt, cuffless trousers, high shoes, and a cap.
- Remove any combustibles, such as a butane lighter or matches, from your person before doing any welding.
- After completion of work, inspect area to ensure it is free of sparks, glowing embers, and flames.
- Use only correct fuses or circuit breakers. Do not oversize or bypass them.
- Follow requirements in OSHA 1910.252 (a) (2) (iv) and NFPA 51B for hot work and have a fire watcher and extinguisher nearby.
- Read and understand the Safety Data Sheets (SDSs) and the manufacturer's instructions for adhesives, coatings, cleaners, consumables, coolants, degreasers, fluxes, and metals.

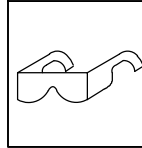

FLYING METAL or DIRT can injure eyes.

- Welding, chipping, wire brushing, and grinding cause sparks and flying metal. As welds cool, they can throw off slag.
- Wear approved safety glasses with side shields even under your welding helmet.



BUILDUP OF GAS can injure or kill.

- Shut off compressed gas supply when not in use.
- Always ventilate confined spaces or use approved air-supplied respirator.

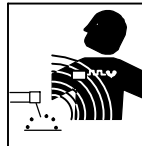

ELECTRIC AND MAGNETIC FIELDS (EMF) can affect Implanted Medical Devices.

- Wearers of Pacemakers and other Implanted Medical Devices should keep away.
- Implanted Medical Device wearers should consult their doctor and the device manufacturer before going near arc welding, spot welding, gouging, plasma arc cutting, or induction heating operations.

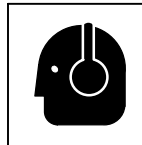

NOISE can damage hearing.

Noise from some processes or equipment can damage hearing.

- Wear approved ear protection if noise level is high.

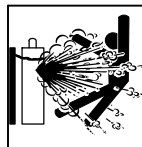

CYLINDERS can explode if damaged.

Compressed gas cylinders contain gas under high pressure. If damaged, a cylinder can explode. Since gas cylinders are normally part of the welding process, be sure to treat them carefully.

- Protect compressed gas cylinders from excessive heat, mechanical shocks, physical damage, slag, open flames, sparks, and arcs.
- Install cylinders in an upright position by securing to a stationary support or cylinder rack to prevent falling or tipping.
- Keep cylinders away from any welding or other electrical circuits.
- Never drape a welding torch over a gas cylinder.
- Never allow a welding electrode to touch any cylinder.
- Never weld on a pressurized cylinder – explosion will result.
- Use only correct compressed gas cylinders, regulators, hoses, and fittings designed for the specific application; maintain them and associated parts in good condition.
- Turn face away from valve outlet when opening cylinder valve. Do not stand in front of or behind the regulator when opening the valve.
- Keep protective cap in place over valve except when cylinder is in use or connected for use.
- Use the right equipment, correct procedures, and sufficient number of persons to lift and move cylinders.
- Read and follow instructions on compressed gas cylinders, associated equipment, and Compressed Gas Association (CGA) publication P-1 listed in Safety Standards.

1-3. Additional Symbols For Installation, Operation, And Maintenance



FIRE OR EXPLOSION hazard.

- Do not install or place unit on, over, or near combustible surfaces.
- Do not install unit near flammables.
- Do not overload building wiring – be sure power supply system is properly sized, rated, and protected to handle this unit.



FALLING EQUIPMENT can injure.

- Use lifting eye to lift unit only, NOT running gear, gas cylinders, or any other accessories.
- Use equipment of adequate capacity to lift and support unit.
- If using lift forks to move unit, be sure forks are long enough to extend beyond opposite side of unit.
- Keep equipment (cables and cords) away from moving vehicles when working from an aerial location.
- Follow the guidelines in the Applications Manual for the Revised NIOSH Lifting Equation (Publication No. 94–110) when manually lifting heavy parts or equipment.



OVERUSE can cause OVERHEATING

- Allow cooling period; follow rated duty cycle.
- Reduce current or reduce duty cycle before starting to weld again.
- Do not block or filter airflow to unit.

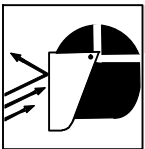

FLYING SPARKS can injure.

- Wear a face shield to protect eyes and face.
- Shape tungsten electrode only on grinder with proper guards in a safe location wearing proper face, hand, and body protection.
- Sparks can cause fires — keep flammables away.

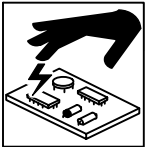

STATIC (ESD) can damage PC boards.

- Put on grounded wrist strap BEFORE handling boards or parts.
- Use proper static-proof bags and boxes to store, move, or ship PC boards.



MOVING PARTS can injure.

- Keep away from moving parts.
- Keep away from pinch points such as drive rolls.



WELDING WIRE can injure.

- Do not press gun trigger until instructed to do so.
- Do not point gun toward any part of the body, other people, or any metal when threading welding wire.



BATTERY EXPLOSION can injure.

- Do not use welder to charge batteries or jump start vehicles unless it has a battery charging feature designed for this purpose.



MOVING PARTS can injure.

- Keep away from moving parts such as fans.
- Keep all doors, panels, covers, and guards closed and securely in place.
- Have only qualified persons remove doors, panels, covers, or guards for maintenance and troubleshooting as necessary.
- Reinstall doors, panels, covers, or guards when maintenance is finished and before reconnecting input power.

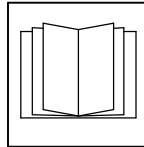

READ INSTRUCTIONS.

- Read and follow all labels and the Owner's Manual carefully before installing, operating, or servicing unit. Read the safety information at the beginning of the manual and in each section.
- Use only genuine replacement parts from the manufacturer.
- Perform installation, maintenance, and service according to the Owner's Manuals, industry standards, and national, state, and local codes.

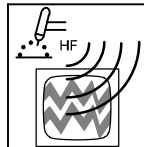

H.F. RADIATION can cause interference.

- High-frequency (H.F.) can interfere with radio navigation, safety services, computers, and communications equipment.
- Have only qualified persons familiar with electronic equipment perform this installation.
- The user is responsible for having a qualified electrician promptly correct any interference problem resulting from the installation.
- If notified by the FCC about interference, stop using the equipment at once.
- Have the installation regularly checked and maintained.
- Keep high-frequency source doors and panels tightly shut, keep spark gaps at correct setting, and use grounding and shielding to minimize the possibility of interference.

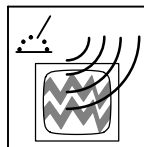

ARC WELDING can cause interference.

- Electromagnetic energy can interfere with sensitive electronic equipment such as computers and computer-driven equipment such as robots.
- Be sure all equipment in the welding area is electromagnetically compatible.
- To reduce possible interference, keep weld cables as short as possible, close together, and down low, such as on the floor.
- Locate welding operation 100 meters from any sensitive electronic equipment.
- Be sure this welding machine is installed and grounded according to this manual.
- If interference still occurs, the user must take extra measures such as moving the welding machine, using shielded cables, using line filters, or shielding the work area.

1-4. California Proposition 65 Warnings

 **Welding or cutting equipment produces fumes or gases which contain chemicals known to the State of California to cause birth defects and, in some cases, cancer. (California Health & Safety Code Section 25249.5 et seq.)**

 **This product contains chemicals, including lead, known to the state of California to cause cancer, birth defects, or other reproductive harm. *Wash hands after use.***

1-5. Principal Safety Standards

Safety in Welding, Cutting, and Allied Processes, ANSI Standard Z49.1, is available as a free download from the American Welding Society at <http://www.aws.org> or purchased from Global Engineering Documents (phone: 1-877-413-5184, website: www.global.ihs.com).

Safe Practices for the Preparation of Containers and Piping for Welding and Cutting, American Welding Society Standard AWS F4.1, from Global Engineering Documents (phone: 1-877-413-5184, website: www.global.ihs.com).

Safe Practices for Welding and Cutting Containers that have Held Combustibles, American Welding Society Standard AWS A6.0, from Global Engineering Documents (phone: 1-877-413-5184, website: www.global.ihs.com).

National Electrical Code, NFPA Standard 70, from National Fire Protection Association, Quincy, MA 02269 (phone: 1-800-344-3555, website: www.nfpa.org and www.sparky.org).

Safe Handling of Compressed Gases in Cylinders, CGA Pamphlet P-1, from Compressed Gas Association, 14501 George Carter Way, Suite 103, Chantilly, VA 20151 (phone: 703-788-2700, website: www.cga-net.com).

Safety in Welding, Cutting, and Allied Processes, CSA Standard W117.2, from Canadian Standards Association, Standards Sales, 5060 Spectrum Way, Suite 100, Mississauga, Ontario, Canada L4W 5N5 (phone: 800-463-6727, website: www.csagroup.org).

Safe Practice For Occupational And Educational Eye And Face Protection, ANSI Standard Z87.1, from American National Standards Institute, 25 West 43rd Street, New York, NY 10036 (phone: 212-642-4900, website: www.ansi.org).

Standard for Fire Prevention During Welding, Cutting, and Other Hot Work, NFPA Standard 51B, from National Fire Protection Association, Quincy, MA 02269 (phone: 1-800-344-3555, website: www.nfpa.org).

OSHA, Occupational Safety and Health Standards for General Industry, Title 29, Code of Federal Regulations (CFR), Part 1910, Subpart Q, and Part 1926, Subpart J, from U.S. Government Printing Office, Superintendent of Documents, P.O. Box 371954, Pittsburgh, PA 15250-7954 (phone: 1-866-512-1800) (there are 10 OSHA Regional Offices—phone for Region 5, Chicago, is 312-353-2220, website: www.osha.gov).

Applications Manual for the Revised NIOSH Lifting Equation, The National Institute for Occupational Safety and Health (NIOSH), 1600 Clifton Rd, Atlanta, GA 30329-4027 (phone: 1-800-232-4636, website: www.cdc.gov/NIOSH).

1-6. EMF Information

Electric current flowing through any conductor causes localized electric and magnetic fields (EMF). The current from arc welding (and allied processes including spot welding, gouging, plasma arc cutting, and induction heating operations) creates an EMF field around the welding circuit. EMF fields can interfere with some medical implants, e.g. pacemakers. Protective measures for persons wearing medical implants have to be taken. For example, restrict access for passers-by or conduct individual risk assessment for welders. All welders should use the following procedures in order to minimize exposure to EMF fields from the welding circuit:

1. Keep cables close together by twisting or taping them, or using a cable cover.
2. Do not place your body between welding cables. Arrange cables to one side and away from the operator.
3. Do not coil or drape cables around your body.

4. Keep head and trunk as far away from the equipment in the welding circuit as possible.
5. Connect work clamp to workpiece as close to the weld as possible.
6. Do not work next to, sit or lean on the welding power source.
7. Do not weld whilst carrying the welding power source or wire feeder.

About Implanted Medical Devices:

Implanted Medical Device wearers should consult their doctor and the device manufacturer before performing or going near arc welding, spot welding, gouging, plasma arc cutting, or induction heating operations. If cleared by your doctor, then following the above procedures is recommended.

SECTION 2 – CONSIGNES DE SÉCURITÉ – LIRE AVANT UTILISATION

fre_som_2015-09

! Pour écarter les risques de blessure pour vous-même et pour autrui — lire, appliquer et ranger en lieu sûr ces consignes relatives aux précautions de sécurité et au mode opératoire.

2-1. Symboles utilisés



DANGER! – Indique une situation dangereuse qui si on l'évite pas peut donner la mort ou des blessures graves. Les dangers possibles sont montrés par les symboles joints ou sont expliqués dans le texte.



Indique une situation dangereuse qui si on l'évite pas peut donner la mort ou des blessures graves. Les dangers possibles sont montrés par les symboles joints ou sont expliqués dans le texte.

AVIS – Indique des déclarations pas en relation avec des blessures personnelles.

Indique des instructions spécifiques.



Ce groupe de symboles veut dire Avertissement! Attention! DANGER DE CHOC ELECTRIQUE, PIECES EN MOUVEMENT, et PIECES CHAUDES. Consulter les symboles et les instructions ci-dessous y afférant pour les actions nécessaires afin d'éviter le danger.

2-2. Dangers relatifs au soudage à l'arc



Les symboles représentés ci-dessous sont utilisés dans ce manuel pour attirer l'attention et identifier les dangers possibles. En présence de l'un de ces symboles, prendre garde et suivre les instructions afférentes pour éviter tout risque. Les instructions en matière de sécurité indiquées ci-dessous ne constituent qu'un sommaire des instructions de sécurité plus complètes fournies dans les normes de sécurité énumérées dans la Section 2-5. Lire et observer toutes les normes de sécurité.



Seul un personnel qualifié est autorisé à installer, faire fonctionner, entretenir et réparer cet appareil.



Pendant le fonctionnement, maintenir à distance toutes les personnes, notamment les enfants de l'appareil.



UNE DÉCHARGE ÉLECTRIQUE peut entraîner la mort.

Le contact d'organes électriques sous tension peut provoquer des accidents mortels ou des brûlures graves. Le circuit de l'électrode et de la pièce est sous tension lorsque le courant est délivré à la sortie. Le circuit d'alimentation et les circuits internes de la machine sont également sous tension lorsque l'alimentation est sur Marche. Dans le mode de soudage avec du fil, le fil, le dérouleur, le bloc de commande du rouleau et toutes les parties métalliques en contact avec le fil sont sous tension électrique. Un équipement installé ou mis à la terre de manière incorrecte ou impropre constitue un danger.

- Ne pas toucher aux pièces électriques sous tension.
- Porter des gants isolants et des vêtements de protection secs et sans trous.
- S'isoler de la pièce à couper et du sol en utilisant des housses ou des tapis assez grands afin d'éviter tout contact physique avec la pièce à couper ou le sol.
- Ne pas se servir de source électrique à courant électrique dans les zones humides, dans les endroits confinés ou là où on risque de tomber.
- Se servir d'une source électrique à courant électrique UNIQUEMENT si le procédé de soudage le demande.
- Si l'utilisation d'une source électrique à courant électrique s'avère nécessaire, se servir de la fonction de télécommande si l'appareil en est équipé.
- D'autres consignes de sécurité sont nécessaires dans les conditions suivantes : risques électriques dans un environnement humide ou si l'on porte des vêtements mouillés ; sur des structures métalliques telles que sols, grilles ou échafaudages ; en position coincée comme assise, à genoux ou couchée ; ou s'il y a un risque élevé de contact inévitable ou accidentel avec la pièce à souder ou le sol. Dans ces conditions, utiliser les équipements suivants, dans l'ordre indiqué : 1) un poste à souder DC à tension constante (à fil), 2) un poste à souder DC manuel (électrode) ou 3) un poste à souder AC à tension à vide réduite. Dans la plupart des situations, l'utilisation d'un poste à souder DC à fil à tension constante est recommandée. En outre, ne pas travailler seul !

- Couper l'alimentation ou arrêter le moteur avant de procéder à l'installation, à la réparation ou à l'entretien de l'appareil. Déverrouiller l'alimentation selon la norme OSHA 29 CFR 1910.147 (voir normes de sécurité).
- Installez, mettez à la terre et utilisez correctement cet équipement conformément à son Manuel d'Utilisation et aux réglementations nationales, gouvernementales et locales.
- Toujours vérifier la terre du cordon d'alimentation. Vérifier et s'assurer que le fil de terre du cordon d'alimentation est bien raccordé à la borne de terre du sectionneur ou que la fiche du cordon est raccordée à une prise correctement mise à la terre.
- En effectuant les raccordements d'entrée, fixer d'abord le conducteur de mise à la terre approprié et contre-vérifier les connexions.
- Les câbles doivent être exempts d'humidité, d'huile et de graisse; protégez-les contre les étincelles et les pièces métalliques chaudes.
- Vérifier fréquemment le cordon d'alimentation et le conducteur de mise à la terre afin de s'assurer qu'il n'est pas altéré ou dénudé –, le remplacer immédiatement s'il l'est –. Un fil dénudé peut entraîner la mort.
- L'équipement doit être hors tension lorsqu'il n'est pas utilisé.
- Ne pas utiliser des câbles usés, endommagés, de grosseur insuffisante ou mal épissés.
- Ne pas enrouler les câbles autour du corps.
- Si la pièce soudée doit être mise à la terre, le faire directement avec un câble distinct.
- Ne pas toucher l'électrode quand on est en contact avec la pièce, la terre ou une électrode provenant d'une autre machine.
- Ne pas toucher des porte électrodes connectés à deux machines en même temps à cause de la présence d'une tension à vide doublée.
- N'utiliser qu'un matériel en bon état. Réparer ou remplacer sur-le-champ les pièces endommagées. Entretien l'appareil conformément à ce manuel.
- Porter un harnais de sécurité si l'on doit travailler au-dessus du sol.
- S'assurer que tous les panneaux et couvercles sont correctement en place.
- Fixer le câble de retour de façon à obtenir un bon contact métal-métal avec la pièce à souder ou la table de travail, le plus près possible de la soudure.
- Isoler la pince de masse quand pas mis à la pièce pour éviter le contact avec tout objet métallique.
- Ne pas raccorder plus d'une électrode ou plus d'un câble de masse à une même borne de sortie de soudage. Débrancher le câble pour le procédé non utilisé.
- Utiliser une protection différentielle lors de l'utilisation d'un équipement auxiliaire dans des endroits humides ou mouillés.

Il reste une TENSION DC NON NÉGLIGEABLE dans les sources de soudage onduleur UNE FOIS l'alimentation coupée.

- Arrêter les convertisseurs, débrancher le courant électrique et décharger les condensateurs d'alimentation selon les instructions indiquées dans la partie Entretien avant de toucher les pièces.



LES PIÈCES CHAUDES peuvent provoquer des brûlures.

- Ne pas toucher à mains nues les parties chaudes.
- Prévoir une période de refroidissement avant de travailler à l'équipement.

- Ne pas toucher aux pièces chaudes, utiliser les outils recommandés et porter des gants de soudage et des vêtements épais pour éviter les brûlures.

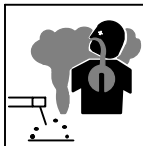

LES FUMÉES ET LES GAZ peuvent être dangereux.

Le soudage génère des fumées et des gaz. Leur inhalation peut être dangereux pour votre santé.

- Eloigner votre tête des fumées. Ne pas respirer les fumées.
- À l'intérieur, ventiler la zone et/ou utiliser une ventilation forcée au niveau de l'arc pour l'évacuation des fumées et des gaz de soudage. Pour déterminer la bonne ventilation, il est recommandé de procéder à un prélèvement pour la composition et la quantité de fumées et de gaz auxquels est exposé le personnel.
- Si la ventilation est médiocre, porter un respirateur anti-vapeurs approuvé.
- Lire et comprendre les fiches de données de sécurité et les instructions du fabricant concernant les adhésifs, les revêtements, les nettoyants, les consommables, les produits de refroidissement, les dégraisseurs, les flux et les métaux.
- Travailler dans un espace fermé seulement s'il est bien ventilé ou en portant un respirateur à alimentation d'air. Demander toujours à un surveillant dûment formé de se tenir à proximité. Des fumées et des gaz de soudage peuvent déplacer l'air et abaisser le niveau d'oxygène provoquant des blessures ou des accidents mortels. S'assurer que l'air de respiration ne présente aucun danger.
- Ne pas souder dans des endroits situés à proximité d'opérations de dégraissage, de nettoyage ou de pulvérisation. La chaleur et les rayons de l'arc peuvent réagir en présence de vapeurs et former des gaz hautement toxiques et irritants.
- Ne pas souder des métaux munis d'un revêtement, tels que l'acier galvanisé, plaqué en plomb ou au cadmium à moins que le revêtement n'ait été enlevé dans la zone de soudure, que l'endroit soit bien ventilé, et en portant un respirateur à alimentation d'air. Les revêtements et tous les métaux renfermant ces éléments peuvent dégager des fumées toxiques en cas de soudage.



LES RAYONS DE L'ARC peuvent provoquer des brûlures dans les yeux et sur la peau.

Le rayonnement de l'arc du procédé de soudage génère des rayons visibles et invisibles intenses (ultraviolets et infrarouges) susceptibles de provoquer des brûlures dans les yeux et sur la peau. Des étincelles sont projetées pendant le soudage.

- Porter un casque de soudage approuvé muni de verres filtrants appropriés pour protéger visage et yeux pour protéger votre visage et vos yeux pendant le soudage ou pour regarder (voir ANSI Z49.1 et Z87.1 énuméré dans les normes de sécurité).
- Porter des lunettes de sécurité avec écrans latéraux même sous votre casque.
- Avoir recours à des écrans protecteurs ou à des rideaux pour protéger les autres contre les rayonnements les éblouissements et les étincelles ; prévenir toute personne sur les lieux de ne pas regarder l'arc.
- Porter un équipement de protection pour le corps fait d'un matériau résistant et ignifuge (cuir, coton robuste, laine). La protection du corps comporte des vêtements sans huile comme par ex. des gants de cuir, une chemise solide, des pantalons sans revers, des chaussures hautes et une casquette.

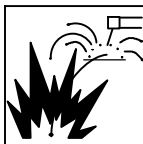

LE SOUDAGE peut provoquer un incendie ou une explosion.

Le soudage effectué sur des conteneurs fermés tels que des réservoirs, tambours ou des conduites peut provoquer leur éclatement. Des étincelles peuvent être projetées de l'arc de soudure. La projection d'étincelles, des

pièces chaudes et des équipements chauds peut provoquer des incendies et des brûlures. Le contact accidentel de l'électrode avec des objets métalliques peut provoquer des étincelles, une explosion, un sur-

chauffement ou un incendie. Avant de commencer le soudage, vérifier et s'assurer que l'endroit ne présente pas de danger.

- Déplacer toutes les substances inflammables à une distance de 10,7 m de l'arc de soudage. En cas d'impossibilité les recouvrir soigneusement avec des protections homologués.
- Ne pas souder dans un endroit où des étincelles peuvent tomber sur des substances inflammables.
- Se protéger et d'autres personnes de la projection d'étincelles et de métal chaud.
- Des étincelles et des matériaux chauds du soudage peuvent facilement passer dans d'autres zones en traversant de petites fissures et des ouvertures.
- Surveiller tout déclenchement d'incendie et tenir un extincteur à proximité.
- Le soudage effectué sur un plafond, plancher, paroi ou séparation peut déclencher un incendie de l'autre côté.
- Ne pas effectuer le soudage sur des conteneurs fermés tels que des réservoirs, tambours, ou conduites, à moins qu'ils n'aient été préparés correctement conformément à AWS F4.1 et AWS A6.0 (voir les Normes de Sécurité).
- Ne pas souder là où l'air ambiant pourrait contenir des poussières, gaz ou émanations inflammables (vapeur d'essence, par exemple).
- Brancher le câble de masse sur la pièce la plus près possible de la zone de soudage pour éviter le transport du courant sur une longue distance par des chemins inconnus éventuels en provoquant des risques d'électrocution, d'étincelles et d'incendie.
- Ne pas utiliser le poste de soudage pour dégeler des conduites gelées.
- En cas de non utilisation, enlever la baguette d'électrode du porte-électrode ou couper le fil à la pointe de contact.
- Porter un équipement de protection pour le corps fait d'un matériau résistant et ignifuge (cuir, coton robuste, laine). La protection du corps comporte des vêtements sans huile comme par ex. des gants de cuir, une chemise solide, des pantalons sans revers, des chaussures hautes et une casquette.
- Avant de souder, retirer toute substance combustible de vos poches telles qu'un allumeur au butane ou des allumettes.
- Une fois le travail achevé, assurez-vous qu'il ne reste aucune trace d'étincelles incandescentes ni de flammes.
- Utiliser exclusivement des fusibles ou coupe-circuits appropriés. Ne pas augmenter leur puissance; ne pas les ponter.
- Suivre les recommandations dans OSHA 1910.252(a)(2)(iv) et NFPA 51B pour les travaux à chaud et avoir de la surveillance et un extincteur à proximité.
- Lire et comprendre les fiches de données de sécurité et les instructions du fabricant concernant les adhésifs, les revêtements, les nettoyants, les consommables, les produits de refroidissement, les dégraisseurs, les flux et les métaux.

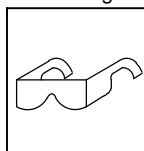

DES PIÈCES DE METAL ou DES SALETES peuvent provoquer des blessures dans les yeux.

- Le soudage, l'écaillage, le passage de la pièce à la brosse en fil de fer, et le meulage génèrent des étincelles et des particules métalliques volantes. Pendant la période de refroidissement des soudures, elles risquent de projeter du laitier.
- Porter des lunettes de sécurité avec écrans latéraux ou un écran facial.



LES ACCUMULATIONS DE GAZ risquent de provoquer des blessures ou même la mort.

- Fermer l'alimentation du gaz comprimé en cas de non utilisation.
- Veiller toujours à bien aérer les espaces confinés ou se servir d'un respirateur d'adduction d'air homologué.

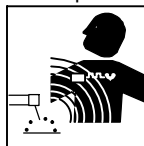

Les CHAMPS ÉLECTROMAGNÉTIQUES (CEM) peuvent affecter les implants médicaux.

- Les porteurs de stimulateurs cardiaques et autres implants médicaux doivent rester à distance.
- Les porteurs d'implants médicaux doivent consulter leur médecin et le fabricant du dispositif avant de s'approcher de la zone où se

déroule du soudage à l'arc, du soudage par points, du gougeage, de la découpe plasma ou une opération de chauffage par induction.



LE BRUIT peut endommager l'ouïe.

Le bruit des processus et des équipements peut affecter l'ouïe.

- Porter des protections approuvées pour les oreilles si le niveau sonore est trop élevé.



LES BOUTEILLES peuvent exploser si elles sont endommagées.

Les bouteilles de gaz comprimé contiennent du gaz sous haute pression. Si une bouteille est endommagée, elle peut exploser. Du fait que

les bouteilles de gaz font normalement partie du procédé de soudage, les manipuler avec précaution.

- Protéger les bouteilles de gaz comprimé d'une chaleur excessive, des chocs mécaniques, des dommages physiques, du laitier, des flammes ouvertes, des étincelles et des arcs.

- Placer les bouteilles debout en les fixant dans un support stationnaire ou dans un porte-bouteilles pour les empêcher de tomber ou de se renverser.
- Tenir les bouteilles éloignées des circuits de soudage ou autres circuits électriques.
- Ne jamais placer une torche de soudage sur une bouteille à gaz.
- Une électrode de soudage ne doit jamais entrer en contact avec une bouteille.
- Ne jamais souder une bouteille pressurisée – risque d'explosion.
- Utiliser seulement des bouteilles de gaz comprimé, régulateurs, tuyaux et raccords convenables pour cette application spécifique; les maintenir ainsi que les éléments associés en bon état.
- Tourner le dos à la sortie de vanne lors de l'ouverture de la vanne de la bouteille. Ne pas se tenir devant ou derrière le régulateur lors de l'ouverture de la vanne.
- Le couvercle du détendeur doit toujours être en place, sauf lorsque la bouteille est utilisée ou qu'elle est reliée pour usage ultérieur.
- Utiliser les équipements corrects, les bonnes procédures et suffisamment de personnes pour soulever et déplacer les bouteilles.
- Lire et suivre les instructions sur les bouteilles de gaz comprimé, l'équipement connexe et le dépliant P-1 de la CGA (Compressed Gas Association) mentionné dans les principales normes de sécurité.

2-3. Dangers supplémentaires en relation avec l'installation, le fonctionnement et la maintenance



Risque D'INCENDIE OU D'EXPLOSION.

- Ne pas placer l'appareil sur, au-dessus ou à proximité de surfaces inflammables.
- Ne pas installer l'appareil à proximité de produits inflammables.

- Ne pas surcharger l'installation électrique – s'assurer que l'alimentation est correctement dimensionnée et protégée avant de mettre l'appareil en service.



LA CHUTE DE L'ÉQUIPEMENT peut provoquer des blessures.

- Utiliser l'anneau de levage uniquement pour soulever l'appareil, NON PAS les chariots, les bouteilles de gaz ou tout autre accessoire.

- Utiliser un équipement de levage de capacité suffisante pour lever l'appareil.
- En utilisant des fourches de levage pour déplacer l'unité, s'assurer que les fourches sont suffisamment longues pour dépasser du côté opposé de l'appareil.
- Tenir l'équipement (câbles et cordons) à distance des véhicules mobiles lors de toute opération en hauteur.
- Suivre les consignes du Manuel des applications pour l'équation de levage NIOSH révisée (Publication N°94-110) lors du levage manuel de pièces ou équipements lourds.

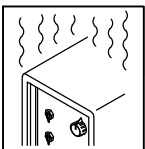

L'EMPLOI EXCESSIF peut SURCHAUFFER L'ÉQUIPEMENT.

- Prévoir une période de refroidissement ; respecter le cycle opératoire nominal.
- Réduire le courant ou le facteur de marche avant de poursuivre le soudage.

- Ne pas obstruer les passages d'air du poste.

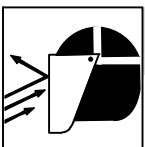

LES ÉTINCELLES PROJÉTÉES peuvent provoquer des blessures.

- Porter un écran facial pour protéger le visage et les yeux.

• Affûter l'électrode au tungstène uniquement à la meuleuse dotée de protecteurs. Cette manœuvre est à exécuter dans un endroit sûr lorsque l'on porte l'équipement homologué de protection du visage, des mains et du corps.

- Les étincelles risquent de causer un incendie – éloigner toute substance inflammable.

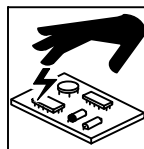

LES CHARGES ÉLECTROSTATIQUES peuvent endommager les circuits imprimés.

- Établir la connexion avec la barrette de terre avant de manipuler des cartes ou des pièces.

- Utiliser des pochettes et des boîtes antistatiques pour stocker, déplacer ou expédier des cartes de circuits imprimés.

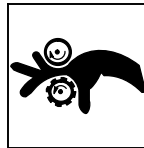

Les PIÈCES MOBILES peuvent causer des blessures.

- Ne pas s'approcher des organes mobiles.
- Ne pas s'approcher des points de coincement tels que des rouleaux de commande.



LES FILS DE SOUDAGE peuvent provoquer des blessures.

- Ne pas appuyer sur la gâchette avant d'en avoir reçu l'instruction.

- Ne pas diriger le pistolet vers soi, d'autres personnes ou toute pièce mécanique en engageant le fil de soudage.

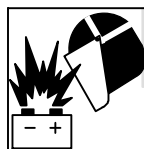

L'EXPLOSION DE LA BATTERIE peut provoquer des blessures.

- Ne pas utiliser l'appareil de soudage pour charger des batteries ou faire démarrer des véhicules à l'aide de câbles de démarrage, sauf si l'appareil dispose d'une fonctionnalité de charge de batterie destinée à cet usage.



Les PIÈCES MOBILES peuvent causer des blessures.

- S'abstenir de toucher des organes mobiles tels que des ventilateurs.

- Maintenir fermés et verrouillés les portes, panneaux, recouvrements et dispositifs de protection.

- Lorsque cela est nécessaire pour des travaux d'entretien et de dépannage, faire retirer les portes, panneaux, recouvrements ou dispositifs de protection uniquement par du personnel qualifié.

- Remettre les portes, panneaux, recouvrements ou dispositifs de protection quand l'entretien est terminé et avant de rebrancher l'alimentation électrique.

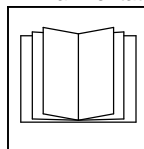

LIRE LES INSTRUCTIONS.

- Lire et appliquer les instructions sur les étiquettes et le Mode d'emploi avant l'installation, l'utilisation ou l'entretien de l'appareil. Lire les informations de sécurité au début du manuel et dans chaque section.

- N'utiliser que les pièces de rechange recommandées par le constructeur.
- Effectuer l'installation, l'entretien et toute intervention selon les manuels d'utilisateurs, les normes nationales, provinciales et de l'industrie, ainsi que les codes municipaux.

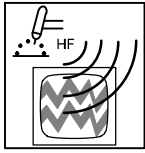

LE RAYONNEMENT HAUTE FRÉQUENCE (H.F.) risque de provoquer des interférences.

- Le rayonnement haute fréquence (H.F.) peut provoquer des interférences avec les équipements de radio-navigation et de communication, les services de sécurité et les ordinateurs.
- Demander seulement à des personnes qualifiées familiarisées avec des équipements électroniques de faire fonctionner l'installation.
- L'utilisateur est tenu de faire corriger rapidement par un électricien qualifié les interférences résultant de l'installation.
- Si le FCC signale des interférences, arrêter immédiatement l'appareil.
- Effectuer régulièrement le contrôle et l'entretien de l'installation.
- Maintenir soigneusement fermés les portes et les panneaux des sources de haute fréquence, maintenir les éclateurs à une distance correcte et utiliser une terre et un blindage pour réduire les interférences éventuelles.

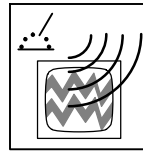

LE SOUDAGE À L'ARC risque de provoquer des interférences.

- L'énergie électromagnétique risque de provoquer des interférences pour l'équipement électronique sensible tel que les ordinateurs et l'équipement commandé par ordinateur tel que les robots.
- Veiller à ce que tout l'équipement de la zone de soudage soit compatible électromagnétiquement.
- Pour réduire la possibilité d'interférence, maintenir les câbles de soudage aussi courts que possible, les grouper, et les poser aussi bas que possible (ex. par terre).
- Veiller à souder à une distance de 100 mètres de tout équipement électronique sensible.
- Veiller à ce que ce poste de soudage soit posé et mis à la terre conformément à ce mode d'emploi.
- En cas d'interférences après avoir pris les mesures précédentes, il incombe à l'utilisateur de prendre des mesures supplémentaires telles que le déplacement du poste, l'utilisation de câbles blindés, l'utilisation de filtres de ligne ou la pose de protecteurs dans la zone de travail.

2-4. Proposition californienne 65 Avertissements

⚠ Les équipements de soudage et de coupage produisent des fumées et des gaz qui contiennent des produits chimiques dont l'État de Californie reconnaît qu'ils provoquent des malformations congénitales et, dans certains cas, des cancers. (Code de santé et de sécurité de Californie, chapitre 25249.5 et suivants)

⚠ Ce produit contient des produits chimiques, notamment du plomb, dont l'État de Californie reconnaît qu'ils provoquent des cancers, des malformations congénitales ou d'autres problèmes de procréation. Se laver les mains après utilisation.

2-5. Principales normes de sécurité

Safety in Welding, Cutting, and Allied Processes, ANSI Standard Z49.1, is available as a free download from the American Welding Society at <http://www.aws.org> or purchased from Global Engineering Documents (phone: 1-877-413-5184, website: www.global.ihs.com).

Safe Practices for the Preparation of Containers and Piping for Welding and Cutting, American Welding Society Standard AWS F4.1, from Global Engineering Documents (phone: 1-877-413-5184, website: www.global.ihs.com).

Safe Practices for Welding and Cutting Containers that have Held Combustibles, American Welding Society Standard AWS A6.0, from Global Engineering Documents (phone: 1-877-413-5184, website: www.global.ihs.com).

National Electrical Code, NFPA Standard 70, from National Fire Protection Association, Quincy, MA 02269 (phone: 1-800-344-3555, website: www.nfpa.org and www.sparky.org).

Safe Handling of Compressed Gases in Cylinders, CGA Pamphlet P-1, from Compressed Gas Association, 14501 George Carter Way, Suite 103, Chantilly, VA 20151 (phone: 703-788-2700, website: www.cganet.com).

Safety in Welding, Cutting, and Allied Processes, CSA Standard W117.2, from Canadian Standards Association, Standards Sales, 5060

Spectrum Way, Suite 100, Mississauga, Ontario, Canada L4W 5N5 (phone: 800-463-6727, website: www.csagroup.org).

Safe Practice For Occupational And Educational Eye And Face Protection, ANSI Standard Z87.1, from American National Standards Institute, 25 West 43rd Street, New York, NY 10036 (phone: 212-642-4900, website: www.ansi.org).

Standard for Fire Prevention During Welding, Cutting, and Other Hot Work, NFPA Standard 51B, from National Fire Protection Association, Quincy, MA 02269 (phone: 1-800-344-3555, website: www.nfpa.org).

OSHA, Occupational Safety and Health Standards for General Industry, Title 29, Code of Federal Regulations (CFR), Part 1910, Subpart Q, and Part 1926, Subpart J, from U.S. Government Printing Office, Superintendent of Documents, P.O. Box 371954, Pittsburgh, PA 15250-7954 (phone: 1-866-512-1800) (there are 10 OSHA Regional Offices—phone for Region 5, Chicago, is 312-353-2220, website: www.osha.gov).

Applications Manual for the Revised NIOSH Lifting Equation, The National Institute for Occupational Safety and Health (NIOSH), 1600 Clifton Rd, Atlanta, GA 30329-4027 (phone: 1-800-232-4636, website: www.cdc.gov/NIOSH).

2-6. Informations relatives aux CEM

Le courant électrique qui traverse tout conducteur génère des champs électromagnétiques (CEM) à certains endroits. Le courant issu d'un soudage à l'arc (et de procédés connexes, y compris le soudage par points, le gougeage, le découpage plasma et les opérations de chauffage par induction) crée un champ électromagnétique (CEM) autour du circuit de soudage. Les champs électromagnétiques produits peuvent causer interférence à certains implants médicaux, p. ex. les stimulateurs cardiaques. Des mesures de protection pour les porteurs d'implants médicaux doivent être prises: Limiter par exemple tout accès aux passants ou procéder à une évaluation des risques individuels pour les soudeurs. Tous les soudeurs doivent appliquer les procédures suivantes pour minimiser l'exposition aux CEM provenant du circuit de soudage:

1. Rassembler les câbles en les torsadant ou en les attachant avec du ruban adhésif ou avec une housse.
2. Ne pas se tenir au milieu des câbles de soudage. Disposer les

câbles d'un côté et à distance de l'opérateur.

3. Ne pas courber et ne pas entourer les câbles autour de votre corps.
4. Maintenir la tête et le torse aussi loin que possible du matériel du circuit de soudage.
5. Connecter la pince sur la pièce aussi près que possible de la soudure.
6. Ne pas travailler à proximité d'une source de soudage, ni s'asseoir ou se pencher dessus.
7. Ne pas souder tout en portant la source de soudage ou le dévidoir.







En ce qui concerne les implants médicaux :



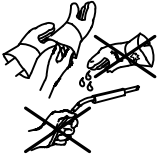
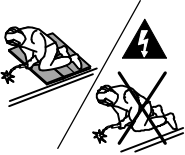
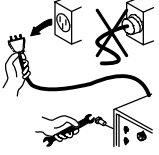
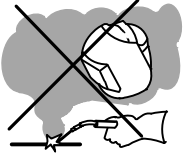

Les porteurs d'implants doivent d'abord consulter leur médecin avant de s'approcher des opérations de soudage à l'arc, de soudage par points, de gougeage, du coupage plasma ou de chauffage par induction. Si le médecin approuve, il est recommandé de suivre les procédures précédentes.

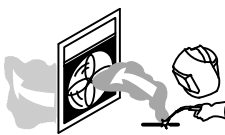
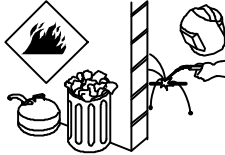
SECTION 3 – DEFINITIONS

3-1. Additional Safety Symbols And Definitions



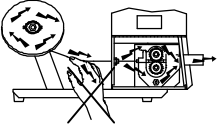

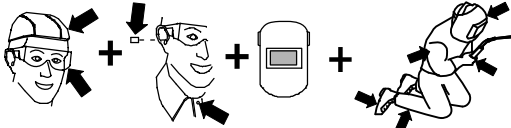
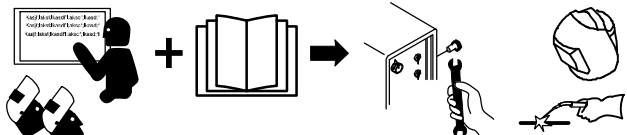



 Some symbols are found only on CE products.







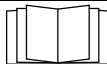

	<p>Warning! Watch Out! There are possible hazards as shown by the symbols.</p> <p style="text-align: right;">Safe1 2012-05</p>
	<p>Do not discard product (where applicable) with general waste. Reuse or recycle Waste Electrical and Electronic Equipment (WEEE) by disposing at a designated collection facility. Contact your local recycling office or your local distributor for further information.</p> <p style="text-align: right;">Safe37 2012-05</p>
	<p>Wear dry insulating gloves. Do not touch electrode (wire) with bare hand. Do not wear wet or damaged gloves.</p> <p style="text-align: right;">Safe57 2012-05</p>
	<p>Protect yourself from electric shock by insulating yourself from work and ground.</p> <p style="text-align: right;">Safe58 2012-06</p>
	<p>Disconnect input plug or power before working on machine.</p> <p style="text-align: right;">Safe5 2012-05</p>
	<p>Keep your head out of the fumes.</p> <p style="text-align: right;">Safe59 2012-05</p>
	<p>Use forced ventilation or local exhaust to remove the fumes.</p> <p style="text-align: right;">Safe60 2012-06</p>
	<p>Use ventilating fan to remove fumes.</p> <p style="text-align: right;">Safe61 2012-06</p>
	<p>Keep flammables away from welding. Do not weld near flammables.</p> <p style="text-align: right;">Safe62 2012-06</p>
	<p>Welding sparks can cause fires. Have a fire extinguisher nearby, and have a watchperson ready to use it.</p> <p style="text-align: right;">Safe63 2012-06</p>











	<p>Do not weld on drums or any closed containers.</p> <p style="text-align: right;">Safe64 2012-06</p>
	<p>Do not remove or paint over (cover) the label.</p> <p style="text-align: right;">Safe20 2012-05</p>
	<p>Drive rolls can injure fingers.</p> <p style="text-align: right;">Safe32 2012-05</p>
	<p>Welding wire and drive parts are at welding voltage during operation – keep hands and metal objects away.</p> <p style="text-align: right;">Safe33 2012-05</p>
	<p>Environmental Protection Use Period (China)</p> <p style="text-align: right;">Safe123 2016-06</p>
	<p>Wear hat and safety glasses. Use ear protection and button shirt collar. Use welding helmet with correct shade of filter. Wear complete body protection.</p> <p style="text-align: right;">Safe66 2012-06</p>
	<p>Become trained and read the instructions before working on the machine or welding.</p> <p style="text-align: right;">Safe65 2012-06</p>

3-2. Miscellaneous Symbols And Definitions

 Some symbols are found only on CE products.

	Output
X	Duty Cycle
	Input
	Constant Current
	Trigger Hold Off
I₁	Primary Current
	Wire Type
	Arc Control
1 	Single Phase
	Read Instructions
A	Amperes
V	Volts
	Direct Current (DC)
Hz	Hertz

	Set Up
	Increase
	Process
t	Time
	Postflow Time
	Gas Input
%	Percent
	Purge By Gas
	Constant Voltage
I₂	Rated Welding Current
	Program
IP	Degree Of Protection

	Variable Inductance
	Preflow Time
	Line Connection
U₂	Conventional Load Voltage
	Wire Feed
	Cold Jog (Inch) Towards Workpiece
	Circuit Breaker
	Trigger Hold On
	Sequence
	Gas Type
	Trigger Control
3 	Three Phase
U₁	Primary Voltage

SECTION 4 – SPECIFICATIONS

4-1. Serial Number And Rating Label Location

The serial number and rating information for this product is located on the rear panel. Use rating label to determine input power requirements and/or rated output. For future reference, write serial number in space provided on back cover of this manual.

4-2. Unit Specifications

Type of Input Power	Welding Power Source Type	Wire Feed Speed Range	Wire Diameter Range	Welding Circuit Rating	Overall Dimensions	Weight
24 Volts AC Single Phase 7 Amperes 50/60 Hz	Constant Voltage (CV) DC With 14-Pin And Contactor Control	75 to 750 ipm (1.9 To 19 mpm)	.023 To 5/64 in. (0.6 To 2 mm) Max Spool Capacity: 18 in. (457 mm) Max Spool Weight: 60 lb (27 kg)	100 Volts, 500 Amperes, 100% Duty Cycle	Length: 23-1/2 in. (597 mm) Width: 10-3/4 in. (273 mm) Height: 11 in. (279 mm)	35 lb (15.9 kg)

4-3. Environmental Specifications

A. IP Rating

IP Rating
IP21S This equipment is designed for indoor use and is not intended to be used or stored outside.
IP21S 2014-06

B. Temperature Specifications

Operating Temperature Range	Storage Temperature Range
14 to 104°F (-10 to 40°C)	-4 to 131°F (-20 to 55°C)
	Temp_2016-07

C. Information On Electromagnetic Compatibility (EMC)

 This Class A equipment is not intended for use in residential locations where the electrical power is provided by the public low-voltage supply system. There can be potential difficulties in ensuring electromagnetic compatibility in those locations, due to conducted as well as radiated disturbances.
ce-emc 3 2014-07

Notes

SECTION 5 – INSTALLATION

5-1. Selecting A Location

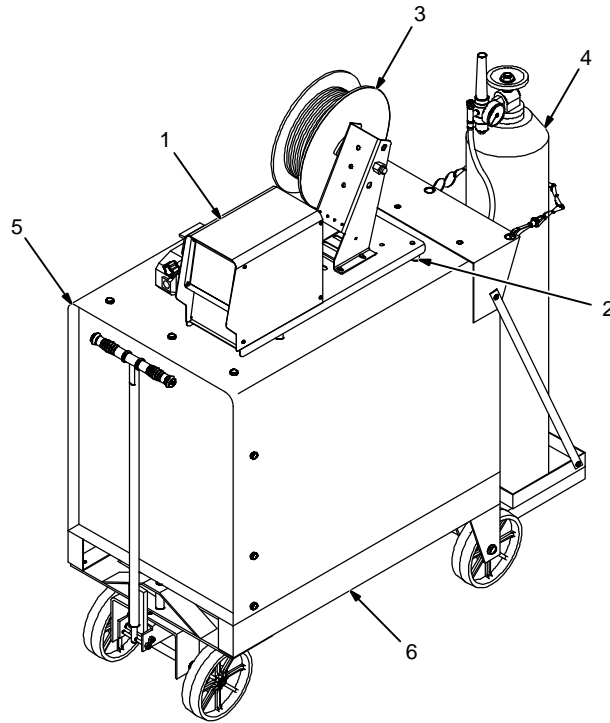
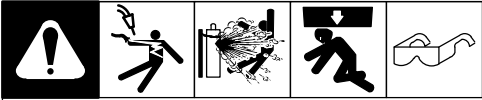

⚠ Do not put feeder where welding wire hits cylinder.

☞ Wire feeder shown is representative only and may not reflect actual unit.

- 1 Wire Feeder
- 2 Rubber Feet

Choose slot that allows all rubber feet to sit securely on top of welding power source.

- 3 Wire Spool/Reel
- 4 Gas Cylinder w/Hose And Regulator (Customer Supplied)

☞ Shielding gas pressure not to exceed 100 psi (689 kPa).

- 5 Welding Power Source
- 6 Running Gear

⚠ Do not move or operate unit where it could tip.

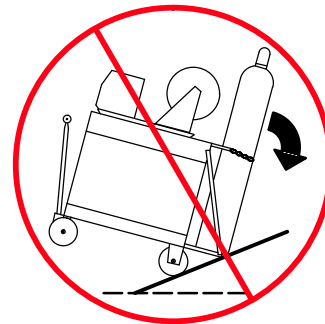

5-2. Equipment Connection Diagrams

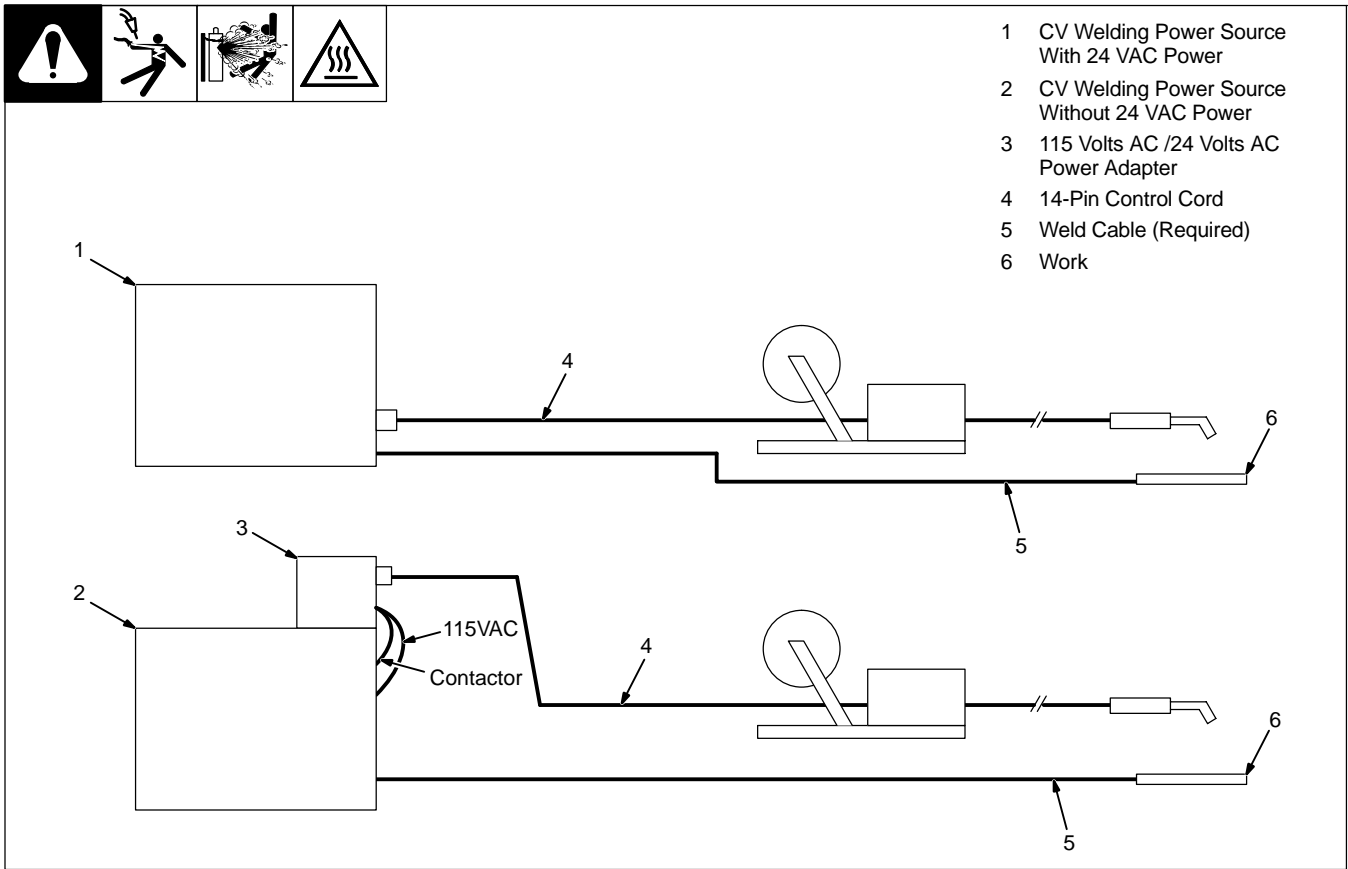

5-3. 14-Pin Plug, Shielding Gas And Optional Volt Sense Lead

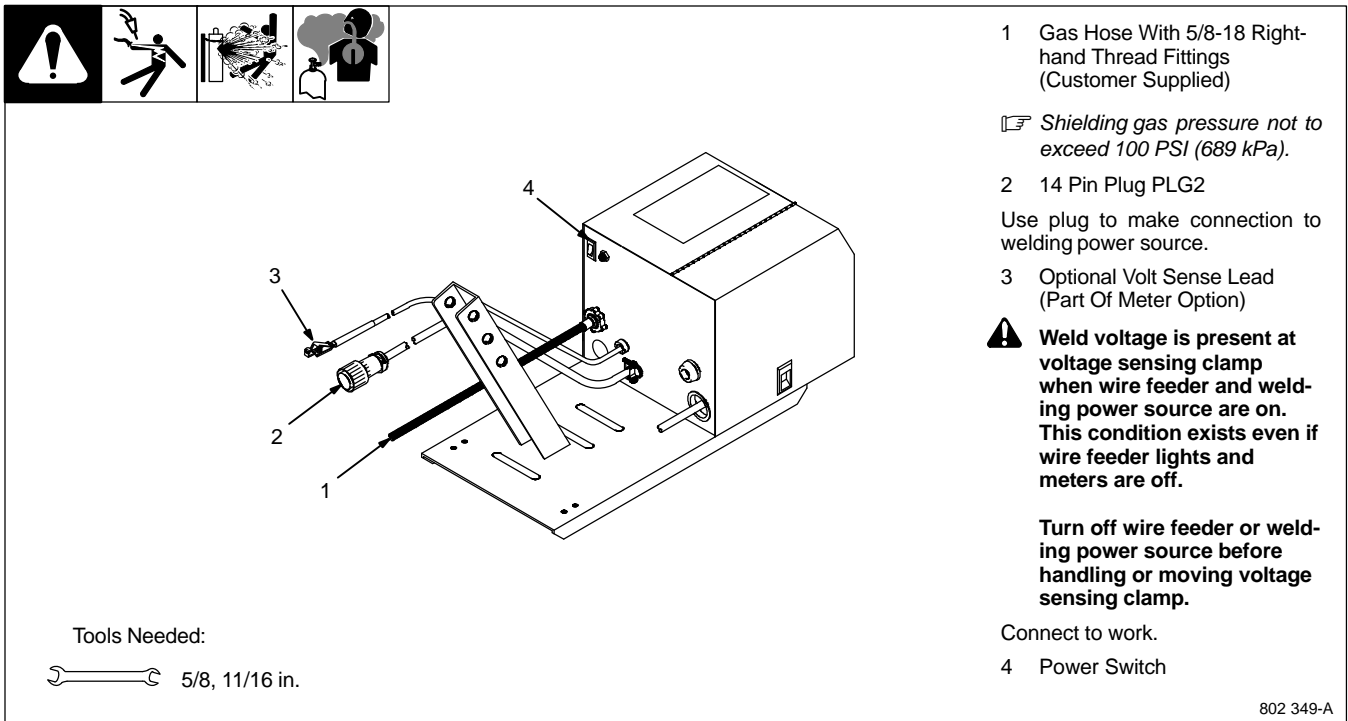

5-4. 14-Pin Plug Information

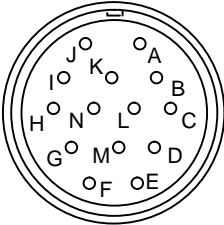
 REMOTE 14	Pin*	Pin Information
	A	24 volts AC with respect to pin G.
	B	Contact closure to A completes 24 volts AC contactor control circuit.
	G	Circuit common for 24 volts AC circuit.
	C	+10 volts DC output to remote control with respect to pin D.
	D	Remote control circuit common.
	E	0 to +10 volts DC input command signal from remote control with respect to pin D.
	F	Current feedback; 0 to 10 volts DC, 1 V/100 A
	H	Voltage feedback; 0 to 10 volts DC, 1 V/10 arc volts

*The remaining pins are not used.

Ref. S-0004-A

5-5. Connecting Welding Gun And Weld Cable



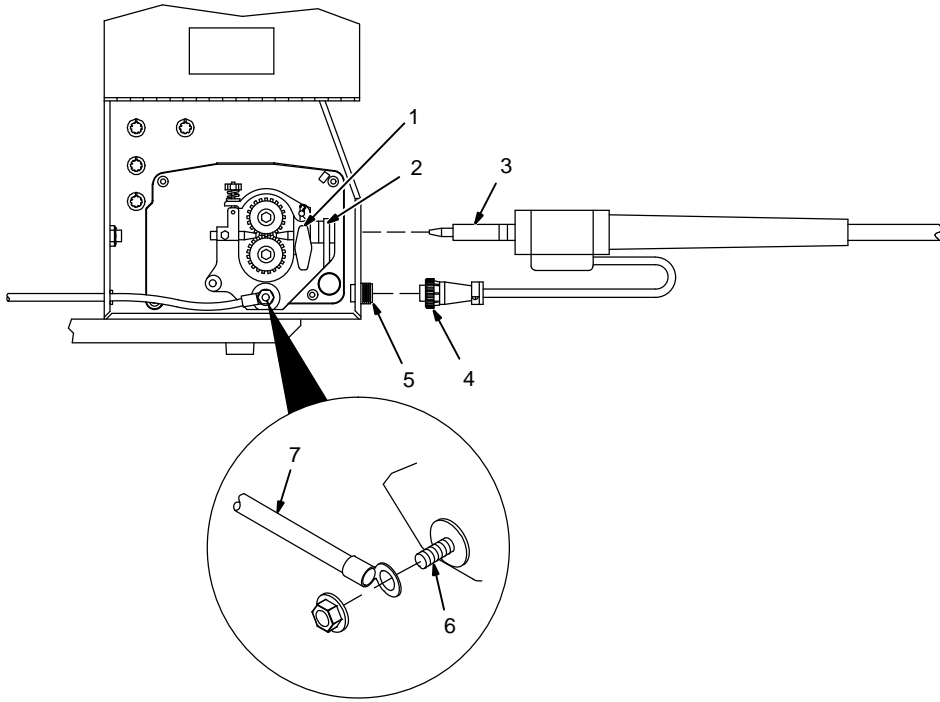

- 1 Gun Securing Knob
- 2 Gun Block
- 3 Gun Outlet Wire Guide

Loosen knob, insert gun into block. Position outlet wire guide as close as possible to drive rolls without touching. Tighten knob.

- 4 Gun Trigger Plug
- 5 Gun Trigger Receptacle
- 6 Weld Cable Terminal
- 7 Weld Cable From Welding Power Source

Tools Needed:

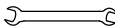
 9/16, 5/8 in.

Ref. 802 356-A

5-6. Optional Meter Circuit Board Settings

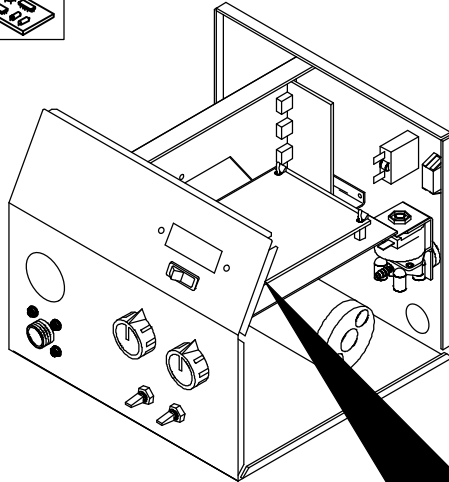

1 Meter Circuit Board

2 DIP Switch S2

Set DIP switch S2 for type of welding power source, and desired wire feed speed display (see illustration).

Reinstall wrapper.

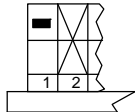

X Means switch position does not affect specified function.

■ Means switch must be in this position.

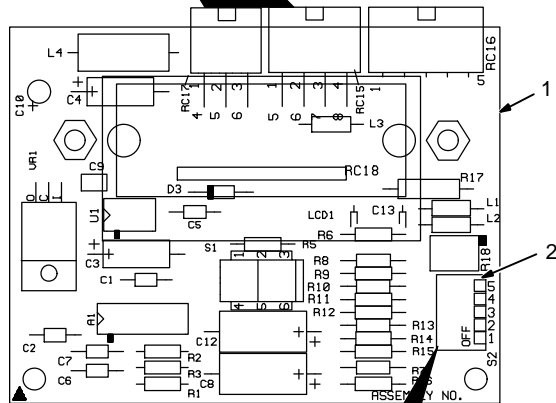

Voltage Sensing Function

Arc Voltage Sensing Using Voltage Sensing Lead For Welding Power Source That Does Not Support Pins F And H

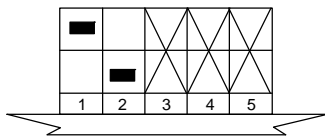
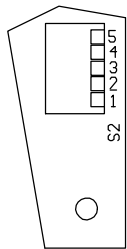

Or

Arc Voltage Sensing Using Feedback From Welding Power Source That Does Support Pins F And H

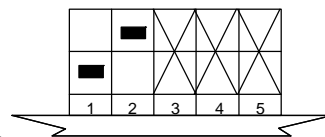

Digital Meter Display

Meters/Minute

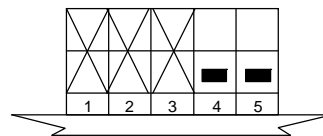

Or

Inches/Minute

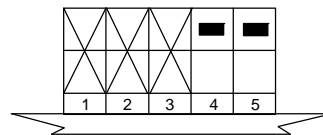

Tools Needed:

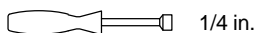

1/4 in.

5-9. Installing And Threading Welding Wire

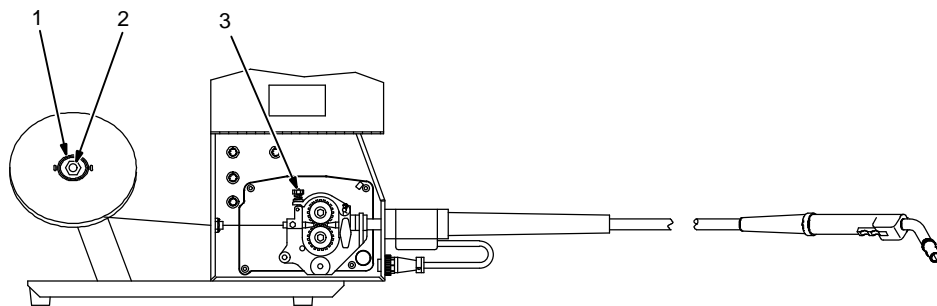

- 1 Retaining Ring
- 2 Hub Tension Adjustment Nut

If necessary, move hub on support for use of different size wire spool.

Remove retaining ring, and install spool so hub pin fits spool hole. Reinstall retaining ring.

Adjust tension nut so wire is taut when wire feed stops.

- 3 Pressure Assembly Adjustment Knob

Lay gun cable out straight.

A Open pressure assembly, hold wire tightly, and cut off end. Push wire through guides into gun.

B Close and tighten pressure assembly. Press JOG button until wire comes out gun.

C To adjust drive roll pressure, press gun trigger to feed wire against wood surface. Tighten knob so wire does not slip.

Cut off wire. Close door.

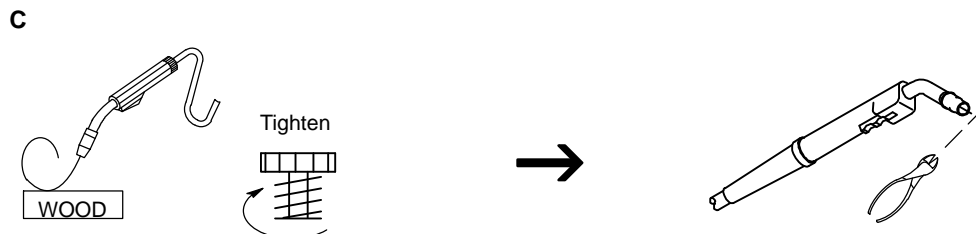
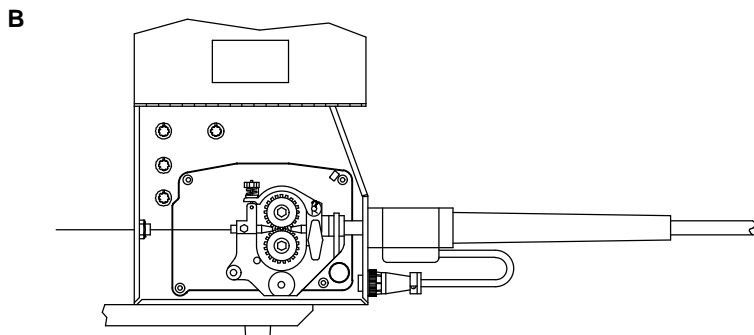
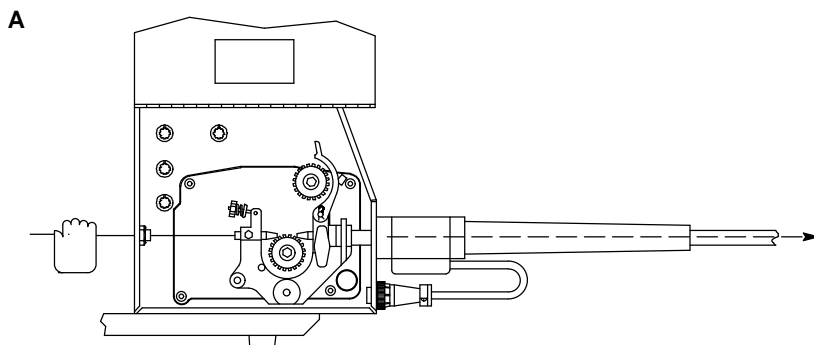

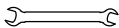
Tools Needed:
 15/16 in.

Ref. 802 356 / S-0627-A

SECTION 6 – OPERATION

6-1. Front Panel Controls

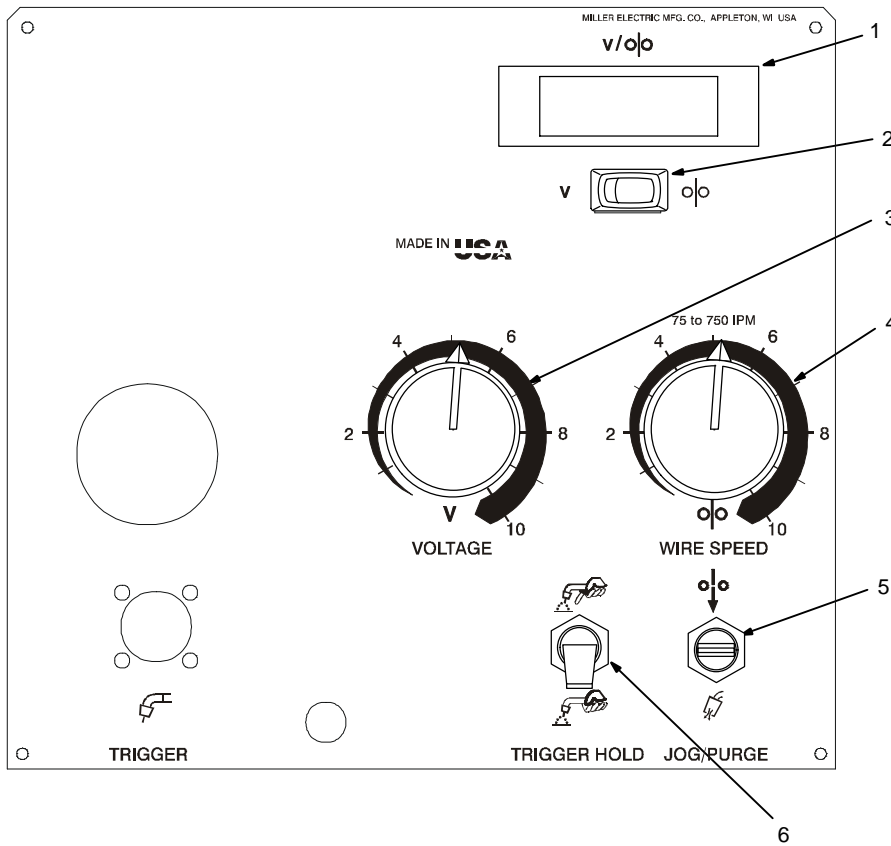
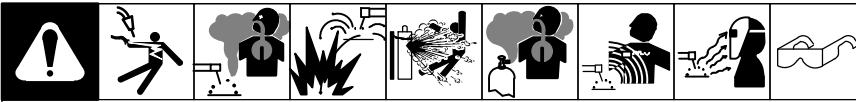

- 1 Optional Voltage/Wire Speed Meter
 - 2 Optional Voltage/Wire Speed Switch
- Use to choose volts or wire feed speed display.
- 3 Optional Remote Voltage Control
- Use to set welding power source voltage at the wire feeder. Numbers are for reference only.
- 4 Wire Speed Control
 - 5 Jog/Purge Switch
- Use Jog position to momentarily feed welding wire at speed set on Wire Speed control without energizing welding circuit or shielding gas valve.
- Use Purge position to momentarily energize gas valve to purge air from gun or adjust gas regulator.
- 6 Trigger Hold Switch
- Push up to weld without holding gun trigger throughout the weld cycle.
- To start weld cycle, press and release gun trigger within three seconds after an arc has been struck. To end weld, press and release gun trigger.
- Power switch is on rear panel (see Section 5-3)

192 503-C

6-2. Optional Side Panel Controls

1 Prewflow Control
Control sets time gas flows before welding wire is energized. Time range is 0 to 5 seconds.

2 Postflow Control
Control sets time gas flows after completion of burnback. Time range is 0 to 5 seconds.

3 Spot Time Control
Factory set for 0.25 to 5 seconds of spot time. Rotating knob fully counterclockwise selects an untimed continuous weld.

4 Run-In Control
Use control to set wire feed speed before arc initiation.
Close side door.

Ref. 802 357-A / Ref. 186 589 / 210 436-A

SECTION 7 – MAINTENANCE & TROUBLESHOOTING

7-1. Routine Maintenance

⚠️ Disconnect power before maintaining.

3 Months

- Replace Unreadable Labels
- Repair Or Replace Cracked Weld Cable
- Clean And Tighten Weld Terminals
- 14-Pin Cord
- Gun Cable
- Gas Hose
- Replace Cracked Parts

6 Months

- Clean Drive Rolls
- Blow Out Or Vacuum Inside, During Heavy Service, Clean Monthly

7-2. Overload Protection

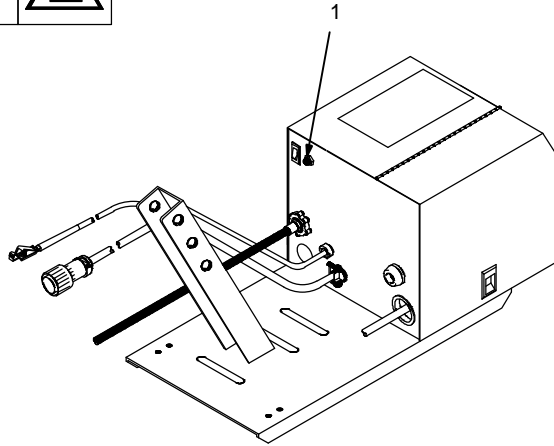
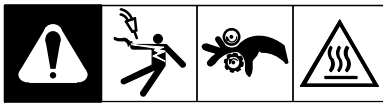

⚠ Turn Off wire feeder and welding power source. Stop engine on welding generator.

1 Supplementary Protector CB1
CB1 protects wire feeder from overload.

Correct problem and manually reset supplementary protector.

802 349-A

7-3. Troubleshooting

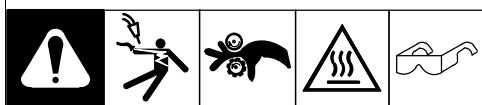

Trouble	Remedy
Wire does not feed, unit completely inoperative.	Turn Power switch On.
	Check 14-pin plug PLG2 connections.
	Check input power.
Wire does not feed.	Check supplementary protector CB1. (see Section 7-2)
	Check gun trigger connection at wire feeder. Check gun trigger leads and trigger switch. See gun Owner's Manual.
	Run-In speed is set to minimum. Normal setting is 50 percent.
	Have Factory Authorized Service Agent check drive motor and control board PC1.
Wire feeds erratically.	Readjust hub tension and drive roll pressure (see Section 5-9).
	Use correct size drive roll (see Parts List).
	Clean or replace dirty or worn drive roll (see Section 5-8).
	Remove weld spatter around nozzle opening.
	Replace contact tip or liner. See gun Owner's Manual.
	Have Factory Authorized Service Agent check drive motor and control board PC1.
Wire feeds when Jog switch is pressed but not when gun trigger is pressed.	Check gun trigger connection at wire feeder. Check gun trigger leads and trigger switch. See gun Owner's Manual.
Wire feeds as soon as power is applied.	Check gun trigger. See gun Owner's Manual.
Wire does not feed until trigger is pressed but continues to feed after trigger is released.	Check for short between gun trigger leads and weld cable. Repair or replace gun trigger leads.
Gas valve rattles loudly and wire feeds slowly or erratically.	Check for short between gun trigger leads and weld cable. Repair or replace gun trigger leads.
Gas does not flow; wire feeds.	Check gas valve and flowmeter.

SECTION 8 – ELECTRICAL DIAGRAM

WARNING

- Do not touch live electrical parts.
- Disconnect input power or stop engine before servicing.
- Do not operate with covers removed.
- Have only qualified persons install, use, or service this unit.

ELECTRIC SHOCK HAZARD

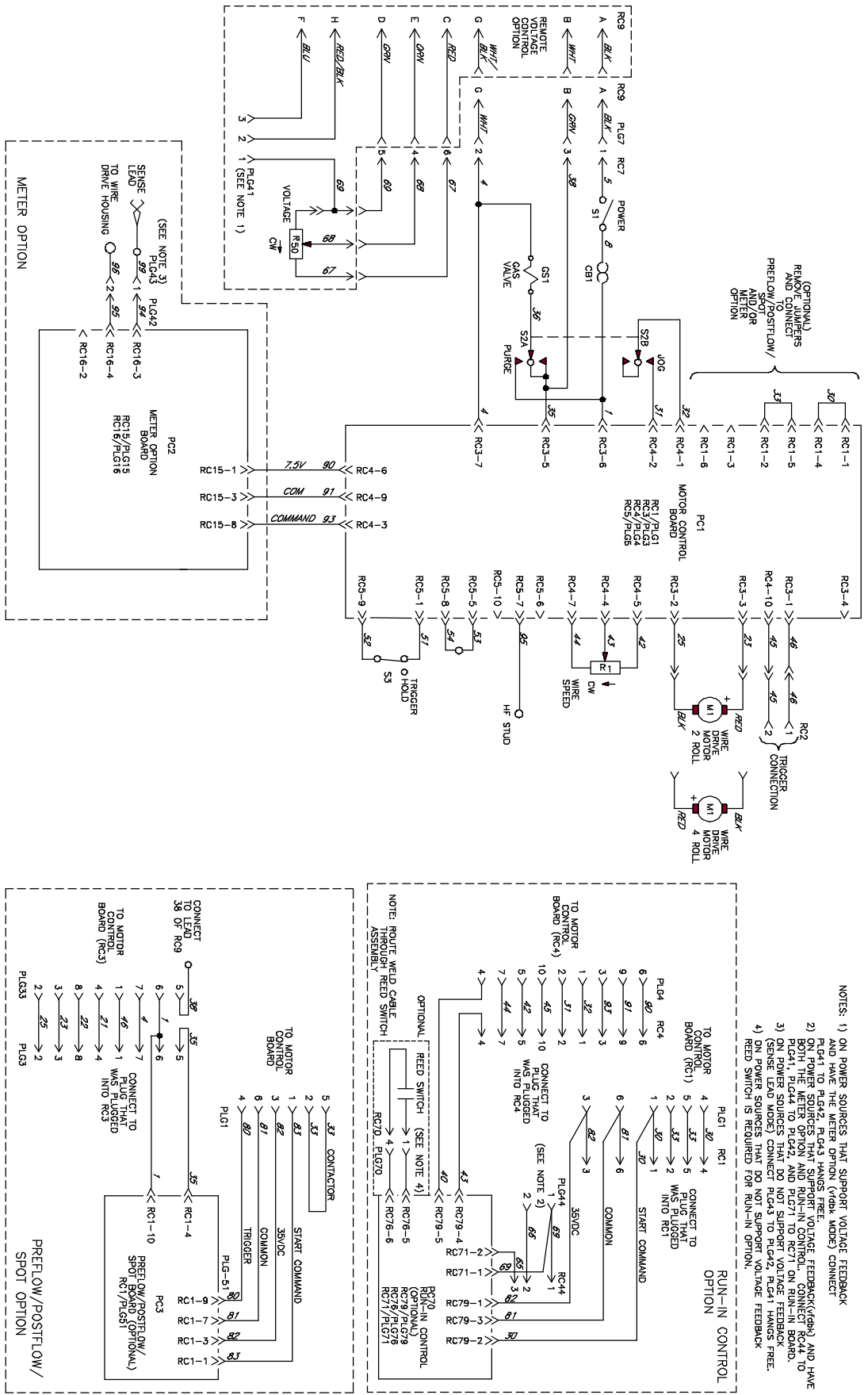



Figure 8-1. Circuit Diagram For Wire Feeder With Optional Equipment

SECTION 9 – PARTS LIST

 Hardware is common and not available unless listed.

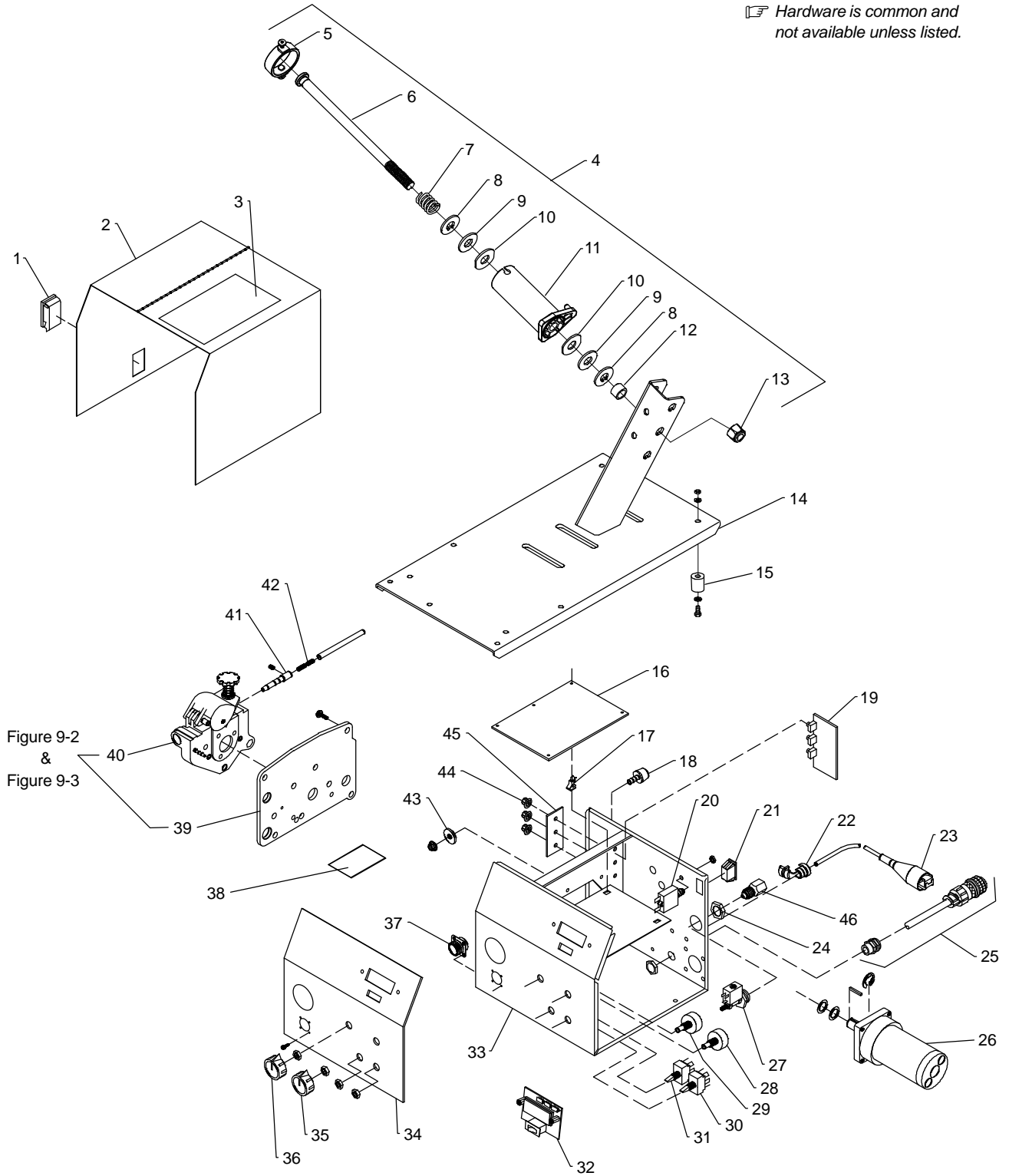

Figure 9-2
&
Figure 9-3

Figure 9-1. Main Assembly

802 358-H

Item No.	Diagram marking	Part No.	Description	Quantity
Figure 9-1. Main Assembly				
1		089899	Latch	1
2		+198650	Wrapper	1
		126873	Bumper	1
3		238487	Label, Warning General Precautionary (CE/Domestic)	1
4		072094	Hub & Spindle Assembly, (Consisting Of)	1
5		058427	Ring, Retaining Spool	1
6		180572	Shaft, Spool Support	1
7		010233	Spring, Cprsn .970 Od X .120 Wire X 1.250	1
8		057971	Washer, Flat Stl Keyed 1.500Dia X .125Thk	2
9		010191	Washer, Fbr .656 Id X 1.500 Od X .125Thk	2
10		058628	Washer, Brake Stl	2
11		058428	Hub, Spool	1
12		248974	Tubing, Stl .875 OD X12Ga Wall X .562	1
13		135205	Nut, Stl Slfkg Hex Reg .625-11 W/Nylon Insert	1
14		137461	Base	1
15		134306	Foot, Rbr 1.250Dia X 1.375 High	4
16	PC1	240352	Circuit Card, Motor	1
17		134201	Stand-Off Support, PC Card	5
18		131181	Wire Guide & Nut	1
19	PC3	◆186297	Circuit Card Assy, Timer	1
		◆098691	Stand-Off, No 6-32 x .500	1
	PLG1	◆115093	Connector & Sockets	1
	PLG3	◆135409	Connector & Pins	1
	PLG33	◆115092	Connector & Sockets	1
	PLG51	◆115091	Connector & Sockets	1
20	CB1	161078	Supplementary Protector, Man Reset 1P 7A 250VAC	1
21	S1	111997	Switch, Rocker Spst 10A 250VAC	1
22		◆138044	Strain Relief	1
23		◆126693	Cable, Sensing 15ft (Includes)	1
		261163	Label, Warning Electric Shock/Volt Sense Clamp	1
24		220805	Nut, 750-14 Nps 1.48Hex .41H Nyl	1
25		192525	Cable, Power 10Ft 4In 18Ga 3C (Used With 22A) (Consisting Of)	11ft
		143922	Connector, Circ Cpc Clamp	1
		139042	Bushing, Strain Relief .270/.470 Id X .804 Mtg Hole	1
		182271	Cable, Port No. 18 3/C	1
	PLG9	141162	Housing Plug & Pins	1
	PLG7	115093	Housing Plug & Skts	1
25		192526	Cable, Power 10Ft 4In 16Ga 8C (Used With 24A) (Consisting Of)	11ft
		079739	Connector, Circ Cpc Clamp	1
		600797	Cable, Port No. 18 3/C	1
	PLG41	131204	Housing Plug & Skts	1
		010325	Bushing, Strain Relief .840 Id X .875 Mtg Hole (Used With 24A)	1
26	M1	193188	Motor, Gear 24VDC 146RPM (Consisting Of)	1
		*136745	Brush & Spring Assembly	2
27	GS1	228036	Valve, 24VAC 1Way .750-14 Thd 2mm orf 100PSI	1
	PLG1	115093	Connector & Sockets	1
	PLG3	115092	Connector & Socket	1
	PLG4	115091	Connector & Socket	1
	PLG5	130203	Connector & Socket	1
28	R1	073562	Pot, Cp Std Slot 1T 2. W 10K Linear	1
29	R50	◆073562	Pot, Cp Std Slot 1T 2. W 10K Linear	1
30	S2	211476	Switch, Tgl Spst 6A 125VAC	1
31	S3	134847	Switch, Tgl Spdt 15A 125VAC	1
		187577	Cover, Opening Meter	1
		◆133644	Frame, Snap-In Switch Rocker	1
32	PC2	◆240355	Circuit Card Assy, Meter (Consisting Of)	1
	LCD1	181355	Meter, Digital	1
	PLG15	◆115092	Connector & Sockets	1
	PLG16	◆131055	Connector & Sockets	1

Item No.	Diagram marking	Part No.	Description	Quantity
Figure 9-1. Main Assembly (Continued)				
		◆115443	Stand-Off, 6-32 X .750 Lg	2
33		249684	Case Assembly	1
		183914	Blank, Snap-In Nyl 1.250 Mtg Hole	1
34			Nameplate (Order By Model And Serial Number)	1
35		171007	Knob, Pointer	1
36		◆◆171007	Knob, Pointer	1
37	RC2	048282	Receptacle W/Sockets	1
38		269731	Label, Warning Hot Surfaces And Moving Parts	1
39	Fig 9-2 & 9-3		Plate, Insulator	1
40	Fig 9-2 & 9-3		Wire Drive Assembly	1
41		188149	Guide, Wire Inlet (Consisting Of) (4 Drive Roll)	1
42		082050	Liner, Monocoil Inlet Wire	1
		082036	Guide, Wire Inlet	1
		187421	Tube, Guide .030-.035	1
		187422	Tube, Guide .045-.062	1
43		010291	Washer, Flat .625 X 1.250 Od X .125Thk Nylafil	1
44		◆093551	Knob, Pointer	3
45		◆186587	Plate, Control Timer	1
		◆187909	Handle, Lifting	1
		◆604423	Grip, Handle	1
		◆188674	Label, Caution Incorrect Lifting	1
		◆192526	Cable, Power (Consisting Of)	1
		079739	Connector, Circ Cpc Clamp	1
		600797	Cable, Port No. 16 8/C 10Ft 4in	11ft
	PLG41	131204	Housing Plug & Skts	1
	PLG7	115093	Housing Plug & Skts	1
	PLG9	141162	Housing Plug & Pins	1
		◆◆010325	Bushing, Strain Relief	1
		◆◆605339	Washer, Tooth	1
		◆604645	Nut, .375-32 X .56 Hex	1
	PC70	◆◆240356	Circuit Card Assy, Control	1
		◆◆194310	Bracket, Mounting	1
		◆◆097132	Stand-Off, 6-32 X .375 Lg .250 Hex	2
		◆◆093551	Knob	1
		◆140789	Switch, Reed	1
		◆◆210436	Label, Indicator Run-In	1
		◆193719	Bracket, Mounting Receptacle	1
		◆115093	Housing Plug & Sockets	1
		◆131059	Housing Plug & Sockets	1
		◆115091	Housing Plug & Sockets	1
		◆135531	Housing Plug & Sockets	1
		◆048282	Housing Plug & Sockets	1
46		211989	Fitting, W/Screen	1

+When ordering a component originally displaying a precautionary label, the label should also be ordered.

◆OPTIONAL

◆◆OPTIONAL IN 22A, STANDARD IN 24A

To maintain the factory original performance of your equipment, use only Manufacturer's Suggested Replacement Parts. Model and serial number required when ordering parts from your local distributor.

Item No.	Dia. Mkgs.	Part No.	Description	Quantity
----------	------------	----------	-------------	----------

Figure 9-2. Drive Assembly, Wire (2 Drive Roll) (Fig 9-1 Item 40)

...	1	602009	...	Screw, .250-20 X 1.250 Soc Hd Hex Gr 8	1
...	2	172075	...	Carrier, Drive Roll W/Component 24 Pitch	1
...	3	054263	...	Screw, Thumb Stl .250-20 X .500	1
...	4	010224	...	Pin, Spring Cs .187 X 1.000	1
...	5	166072	...	Spacer, Gear	1
...	6	237842	...	Fastener, Pinned	1
...	7	085244	...	Washer, Cupped Stl .328 Id X .812 Od X .125	1
...	8	089477	...	Spring, Cprsn .770 Od X .105 Wire X 1.225	1
...	9	240975	...	Knob, Adjustment Tension	1
...	10	166071	...	Lever, Mtg Pressure Gear	1
...	11	151828	...	Pin, Cotter Hair .054 X .750	3
...	12	079634	...	Pin, Hinge	1
...	13	144172	...	Fitting, Hose Brs Barbed M 3/16 Tbg X .250-20	1
...	14	233319	...	Housing, Adapter Gun/Feeder	1
...	15	048449	...	Washer, Shldr Nyl .363 Od X .194 Id X .703	2
...	16	124778	...	Knob, T 2.000 Bar W/.312-18 X 1.000lg	1
...	17	605308	...	Ring, Rtnng Ext .500 Shaft	1
...	18	079625	...	Washer, Wave .500 Id X .750 Od X .015Thk	2
...	19	121271	...	Screw, .250-20 X .500 Soc Hd	1
...	20	172076	...	Carrier, Drive Roll W/Components 24 Pitch	1
...	21	192874	...	Insulator, Motor Drive	1
...	22	234074	...	Clamp, Pin Power	1
...	23	234073	...	Pin, Hinge	1

See Table 9-1 For
Drive Roll & Wire Guide Kits

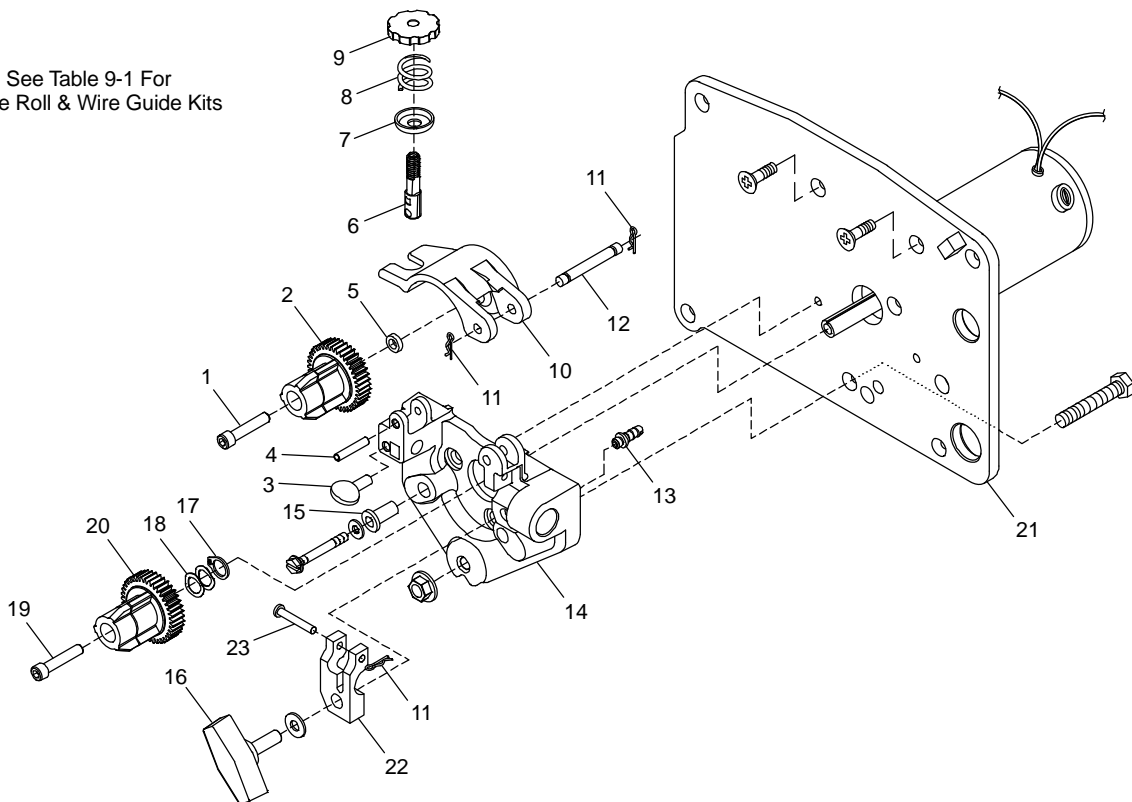

802 019-C

Figure 9-2. Drive Assembly, Wire (2 Drive Roll)

To maintain the factory original performance of your equipment, use only Manufacturer's Suggested Replacement Parts. Model and serial number required when ordering parts from your local distributor.

Item No.	Dia. Mkgs.	Part No.	Description	Quantity
----------	------------	----------	-------------	----------

Figure 9-3. Drive Assembly, Wire (4 Drive Roll) (Fig 9-1 Item 40)

1		602009	Screw, .250-20 X 1.250 Soc Hd Hex Gr 8	4
2		172075	Carrier, Drive Roll W/Component 24 Pitch	4
3		166072	Spacer, Gear	4
4		054263	Screw, Thumb Stl .250-20 X .500	2
5		010224	Pin, Spring Cs .187 X 1.000	2
6		237842	Fastener, Pinned	2
7		085244	Washer, Cupped Stl .328 Id X .812 Od X .125	2
8		089477	Spring, Cprsn .770 Od X .105 Wire X 1.225	2
9		240975	Knob, Adjust Tension 1.250 Dia X .312-18 Thrd	2
10		230691	Lever, Mtg Pressure Gear	1
11		079634	Pin, Hinge	1
12		151828	Pin, Cotter Hair .054 X .750	2
13		238728	Lever, Mtg Pressure Gear	1
14		605308	Ring, Rtnng Ext .500 Shaft	1
15		192875	Insulator, Motor Drive (4 Roll)	1
16		187325	Insulator, Drive Assembly	1
17		144172	Fitting, Hose Brs Barbed M 3/16 Tbg X .250-20	1
18		238726	Housing, Adapter Gun/Feeder	1
19		124778	Knob, T 2.000 Bar W/.312-18 X 1.000lg	1
20		221654	Washer, Shldr Insulating	2
21		079625	Washer, Wave .500 Id X .750 Od X .015Thk	2
22		253187	Spacer, Stl .500 Id X .875 Od X 14 Ga	1
23		092865	Key, Stl	1
24		172077	Carrier, Drive Roll Keyed 24 Pitch	1
25		121271	Screw, .250-20 X .500 Soc Hd	1

 Hardware is common and not available unless listed.

See Table 9-2 For Drive Roll & Wire Guide Kits

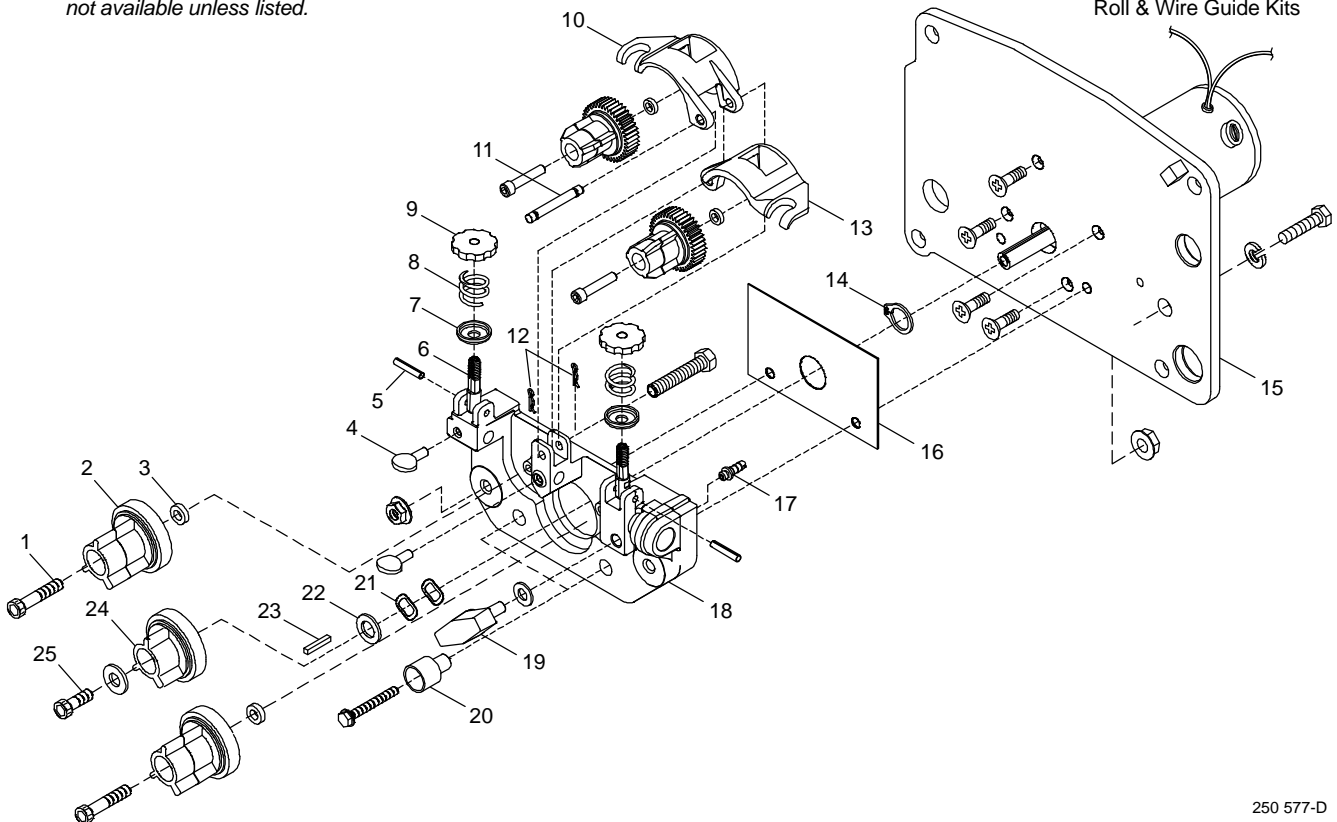

Figure 9-3. Drive Assembly, Wire (4 Drive Roll)

To maintain the factory original performance of your equipment, use only Manufacturer's Suggested Replacement Parts. Model and serial number required when ordering parts from your local distributor.

Table 9-1. Drive Roll And Wire Guide Kits (2 Drive Roll)

☞ Base selection of drive rolls upon the following recommended usages:

1. V-Grooved rolls for hard wire.
2. U-Grooved rolls for soft and soft shelled cored wires.
3. U-Cogged rolls for extremely soft shelled wires (usually hard surfacing types).
4. V-Knurled rolls for hard shelled cored wires.
5. Drive roll types may be mixed to suit particular requirements (example:
V-Knurled roll in combination with U-Grooved).

Wire Diameter			Kit No.	Drive Roll		Inlet Wire Guide
Fraction	Decimal	Metric		Part No.	Type	
.023/.025 in.	.023/.025 in.	0.6 mm	087131	087130	V-Grooved	056192
.030 in.	.030 in.	0.8 mm	079594	053695	V-Grooved	056192
.035 in.	.035 in.	0.9 mm	079595	053700	V-Grooved	056192
.040 in.	.040 in.	1.0 mm	161189	053696	V-Grooved	056192
.045 in.	.045 in.	1.2 mm	079596	053697	V-Grooved	056193
.052 in.	.052 in.	1.3 mm	079597	053698	V-Grooved	056193
1/16 in.	.062 in.	1.6 mm	079598	053699	V-Grooved	056195
.035 in.	.035 in.	0.9 mm	044749	072000	U-Grooved	056192
.045 in.	.045 in.	1.2 mm	079599	053701	U-Grooved	056193
.052 in.	.052 in.	1.3 mm	079600	053702	U-Grooved	056193
1/16 in.	.062 in.	1.6 mm	079601	053706	U-Grooved	056195
5/64 in.	.079 in.	2.0 mm	079602	053704	U-Grooved	056195
.035 in.	.035 in.	0.9 mm	079606	132958	V-Knurled	056192
.045 in.	.045 in.	1.2 mm	079607	132957	V-Knurled	056193
.052 in.	.052 in.	1.3 mm	079608	132956	V-Knurled	056193
1/16 in.	.062 in.	1.6 mm	079609	132955	V-Knurled	056195
.068-.072 in.	.068-.072 in.	1.8 mm	089984	132959	V-Knurled	056195
5/64 in.	.079 in.	2.0 mm	079610	132960	V-Knurled	056195
.045 in.	.045 in.	1.2 mm	083318	083489	U-Cogged	056193
.052 in.	.052 in.	1.3 mm	083317	083490	U-Cogged	056193
1/16 in.	.062 in.	1.6 mm	079614	053708	U-Cogged	056195
5/64 in.	.079 in.	2.0 mm	079615	053710	U-Cogged	056195

S-0157-C

Table 9-2. Drive Roll & Wire Guide Kits (4 Drive Roll)

☞ Base selection of drive rolls upon the following recommended usages:

1. V-Grooved rolls for hard wire.
2. U-Grooved rolls for soft and soft shelled cored wires.
3. U-Cogged rolls for extremely soft shelled wires (usually hard surfacing types).
4. V-Knurled rolls for hard shelled cored wires.
5. Drive roll types may be mixed to suit particular requirements (example:
V-Knurled roll in combination with U-Grooved).

Wire Diameter			Kit No.	Drive Roll		Wire Guide	
Fraction	Decimal	Metric		Part No.	Type	Inlet	Intermediate
.023/.025 in.	.023/.025 in.	0.6 mm	087132	087130	V-Grooved	056192	056206
.030 in.	.030 in.	0.8 mm	046780	053695	V-Grooved	056192	056206
.035 in.	.035 in.	0.9 mm	046781	053700	V-Grooved	056192	056206
.040 in.	.040 in.	1.0 mm	191917	053696	V-Grooved	056192	056206
.045 in.	.045 in.	1.2 mm	046782	053697	V-Grooved	056193	056207
.052 in.	.052 in.	1.3 mm	046783	053698	V-Grooved	056193	056207
1/16 in.	.062 in.	1.6 mm	046784	053699	V-Grooved	056195	056209
.035 in.	.035 in.	0.9 mm	044750	072000	U-Grooved	056192	056206
.045 in.	.045 in.	1.2 mm	046785	053701	U-Grooved	056193	056207
.052 in.	.052 in.	1.3 mm	046786	053702	U-Grooved	056193	056207
1/16 in.	.062 in.	1.6 mm	046787	053706	U-Grooved	056195	056209
5/64 in.	.079 in.	2.0 mm	046788	053704	U-Grooved	056195	056209
.035 in.	.035 in.	0.9 mm	046792	132958	V-Knurled	056192	056206
.045 in.	.045 in.	1.2 mm	046793	132957	V-Knurled	056193	056207
.052 in.	.052 in.	1.3 mm	046794	132956	V-Knurled	056193	056207
1/16 in.	.062 in.	1.6 mm	046795	132955	V-Knurled	056195	056209
5/64 in.	.079 in.	2.0 mm	046796	132960	V-Knurled	056195	056209
.045 in.	.045 in.	1.2 mm	083319	083489	U-Cogged	056193	056207
1/16 in.	.062 in.	1.6 mm	046800	053708	U-Cogged	056195	056209
5/64 in.	.079 in.	2.0 mm	046801	053710	U-Cogged	056195	056209

Ref. S-0025-D

TRUE BLUE[®]

WARRANTY

Effective January 1, 2016

(Equipment with a serial number preface of MG or newer)

This limited warranty supersedes all previous Miller warranties and is exclusive with no other guarantees or warranties expressed or implied.

Warranty Questions?

Call
1-800-4-A-MILLER
for your local
Miller distributor.

Your distributor also gives you ...

Service

You always get the fast, reliable response you need. Most replacement parts can be in your hands in 24 hours.

Support

Need fast answers to the tough welding questions? Contact your distributor. The expertise of the distributor and Miller is there to help you, every step of the way.

LIMITED WARRANTY – Subject to the terms and conditions below, Miller Electric Mfg. Co., Appleton, Wisconsin, warrants to its original retail purchaser that new Miller equipment sold after the effective date of this limited warranty is free of defects in material and workmanship at the time it is shipped by Miller. THIS WARRANTY IS EXPRESSLY IN LIEU OF ALL OTHER WARRANTIES, EXPRESS OR IMPLIED, INCLUDING THE WARRANTIES OF MERCHANTABILITY AND FITNESS.

Within the warranty periods listed below, Miller will repair or replace any warranted parts or components that fail due to such defects in material or workmanship. Miller must be notified in writing within thirty (30) days of such defect or failure, at which time Miller will provide instructions on the warranty claim procedures to be followed. If notification is submitted as an online warranty claim, the claim must include a detailed description of the fault and the troubleshooting steps taken to identify failed components and the cause of their failure.

Miller shall honor warranty claims on warranted equipment listed below in the event of such a failure within the warranty time periods. All warranty time periods start on the delivery date of the equipment to the original end-user purchaser, and not to exceed twelve months after the equipment is shipped to a North American distributor or eighteen months after the equipment is shipped to an International distributor.

1. 5 Years Parts — 3 Years Labor
 - * Original Main Power Rectifiers Only to Include SCRs, Diodes, and Discrete Rectifier Modules
2. 3 Years — Parts and Labor
 - * Auto-Darkening Helmet Lenses (Except Classic Series) (No Labor)
 - * Engine Driven Welder/Generators
(NOTE: Engines are Warranted Separately by the Engine Manufacturer.)
 - * Inverter Power Sources (Unless Otherwise Stated)
 - * Plasma Arc Cutting Power Sources
 - * Process Controllers
 - * Semi-Automatic and Automatic Wire Feeders
 - * Transformer/Rectifier Power Sources
3. 2 Years — Parts and Labor
 - * Auto-Darkening Helmet Lenses – Classic Series Only (No Labor)
 - * Fume Extractors – Capture 5, Filtair 400 and Industrial Collector Series
4. 1 Year — Parts and Labor Unless Specified
 - * Automatic Motion Devices
 - * CoolBelt and CoolBand Blower Unit (No Labor)
 - * Desiccant Air Dryer System
 - * External Monitoring Equipment and Sensors
 - * Field Options
(NOTE: Field options are covered for the remaining warranty period of the product they are installed in, or for a minimum of one year — whichever is greater.)
 - * RFCS Foot Controls (Except RFCS-RJ45)
 - * Fume Extractors – Filtair 130, MWX and SWX Series
 - * HF Units
 - * ICE/XT Plasma Cutting Torches (No Labor)
 - * Induction Heating Power Sources, Coolers
(NOTE: Digital Recorders are Warranted Separately by the Manufacturer.)
 - * LiveArc Welding Performance Management System
 - * Load Banks
 - * Motor-Driven Guns (except Spoolmate Spoolguns)
 - * PAPR Blower Unit (No Labor)
 - * Positioners and Controllers
 - * Racks
 - * Running Gear/Trailers
 - * Spot Welders
 - * Subarc Wire Drive Assemblies
 - * Water Coolant Systems
 - * TIG Torches (No Labor)
 - * Wireless Remote Foot/Hand Controls and Receivers
 - * Work Stations/Weld Tables (No Labor)

5. 6 Months — Parts
 - * Batteries
 - * Bernard Guns (No Labor)
 - * Tregaskiss Guns (No Labor)
6. 90 Days — Parts
 - * Accessory (Kits)
 - * Canvas Covers
 - * Induction Heating Coils and Blankets, Cables, and Non-Electronic Controls
 - * M-Guns
 - * MIG Guns and Subarc (SAW) Torches
 - * Remote Controls and RFCS-RJ45
 - * Replacement Parts (No labor)
 - * Roughneck Guns
 - * Spoolmate Spoolguns

Miller's True Blue[®] Limited Warranty shall not apply to:

1. **Consumable components; such as contact tips, cutting nozzles, contactors, brushes, relays, work station table tops and welding curtains, or parts that fail due to normal wear. (Exception: brushes and relays are covered on all engine-driven products.)**
2. Items furnished by Miller, but manufactured by others, such as engines or trade accessories. These items are covered by the manufacturer's warranty, if any.
3. Equipment that has been modified by any party other than Miller, or equipment that has been improperly installed, improperly operated or misused based upon industry standards, or equipment which has not had reasonable and necessary maintenance, or equipment which has been used for operation outside of the specifications for the equipment.

MILLER PRODUCTS ARE INTENDED FOR PURCHASE AND USE BY COMMERCIAL/INDUSTRIAL USERS AND PERSONS TRAINED AND EXPERIENCED IN THE USE AND MAINTENANCE OF WELDING EQUIPMENT.

In the event of a warranty claim covered by this warranty, the exclusive remedies shall be, at Miller's option: (1) repair; or (2) replacement; or, where authorized in writing by Miller in appropriate cases, (3) the reasonable cost of repair or replacement at an authorized Miller service station; or (4) payment of or credit for the purchase price (less reasonable depreciation based upon actual use) upon return of the goods at customer's risk and expense. Miller's option of repair or replacement will be F.O.B., Factory at Appleton, Wisconsin, or F.O.B. at a Miller authorized service facility as determined by Miller. Therefore no compensation or reimbursement for transportation costs of any kind will be allowed.

TO THE EXTENT PERMITTED BY LAW, THE REMEDIES PROVIDED HEREIN ARE THE SOLE AND EXCLUSIVE REMEDIES. IN NO EVENT SHALL MILLER BE LIABLE FOR DIRECT, INDIRECT, SPECIAL, INCIDENTAL OR CONSEQUENTIAL DAMAGES (INCLUDING LOSS OF PROFIT), WHETHER BASED ON CONTRACT, TORT OR ANY OTHER LEGAL THEORY.

ANY EXPRESS WARRANTY NOT PROVIDED HEREIN AND ANY IMPLIED WARRANTY, GUARANTY OR REPRESENTATION AS TO PERFORMANCE, AND ANY REMEDY FOR BREACH OF CONTRACT TORT OR ANY OTHER LEGAL THEORY WHICH, BUT FOR THIS PROVISION, MIGHT ARISE BY IMPLICATION, OPERATION OF LAW, CUSTOM OF TRADE OR COURSE OF DEALING, INCLUDING ANY IMPLIED WARRANTY OF MERCHANTABILITY OR FITNESS FOR PARTICULAR PURPOSE, WITH RESPECT TO ANY AND ALL EQUIPMENT FURNISHED BY MILLER IS EXCLUDED AND DISCLAIMED BY MILLER.

Some states in the U.S.A. do not allow limitations of how long an implied warranty lasts, or the exclusion of incidental, indirect, special or consequential damages, so the above limitation or exclusion may not apply to you. This warranty provides specific legal rights, and other rights may be available, but may vary from state to state.

In Canada, legislation in some provinces provides for certain additional warranties or remedies other than as stated herein, and to the extent that they may not be waived, the limitations and exclusions set out above may not apply. This Limited Warranty provides specific legal rights, and other rights may be available, but may vary from province to province.

miller_warr 2016-01





Owner's Record

Please complete and retain with your personal records.

Model Name

Serial/Style Number

Purchase Date

(Date which equipment was delivered to original customer.)

Distributor

Address

City

State

Zip



For Service

Contact a **DISTRIBUTOR** or **SERVICE AGENCY** near you.

Always provide Model Name and Serial/Style Number.

Contact your Distributor for:

Welding Supplies and Consumables

Options and Accessories

Personal Safety Equipment

Service and Repair

Replacement Parts

Training (Schools, Videos, Books)

Technical Manuals (Servicing Information and Parts)

Circuit Diagrams

Welding Process Handbooks

To locate a Distributor or Service Agency visit www.millerwelds.com or call 1-800-4-A-Miller

Contact the Delivering Carrier to:

File a claim for loss or damage during shipment.

For assistance in filing or settling claims, contact your distributor and/or equipment manufacturer's Transportation Department.

Miller Electric Mfg. Co.

An Illinois Tool Works Company
1635 West Spencer Street
Appleton, WI 54914 USA

International Headquarters—USA

USA Phone: 920-735-4505 Auto-Attended
USA & Canada FAX: 920-735-4134
International FAX: 920-735-4125

For International Locations Visit
www.MillerWelds.com

