

# ***Hypertherm***<sup>®</sup>

## **Powermax30<sup>®</sup> XP**

Plasma Arc Cutting System



Operator Manual

808160 | Revision 3 | English

## Register your new Hypertherm system

Register your product online at [www.hypertherm.com/registration](http://www.hypertherm.com/registration) for easier technical and warranty support. You can also receive updates on new Hypertherm products and a free gift as a token of our appreciation.

### For your records

Serial number: \_\_\_\_\_

Purchase date: \_\_\_\_\_

Distributor: \_\_\_\_\_

\_\_\_\_\_

\_\_\_\_\_

Maintenance notes:

\_\_\_\_\_

\_\_\_\_\_

\_\_\_\_\_

\_\_\_\_\_

\_\_\_\_\_

\_\_\_\_\_

Powermax, Duramax, FineCut, HyAccess, and Hypertherm are trademarks of Hypertherm Inc. and may be registered in the United States and other countries. All other trademarks are the property of their respective holders.

# ***Powermax30 XP***

## **Operator Manual**

808160  
Revision 3

English

June 2015

Hypertherm Inc.  
Hanover, NH 03755 USA  
[www.hypertherm.com](http://www.hypertherm.com)

**Hypertherm Inc.**

Etna Road, P.O. Box 5010

Hanover, NH 03755 USA

603-643-3441 Tel (Main Office)

603-643-5352 Fax (All Departments)

info@hypertherm.com (Main Office Email)

**800-643-9878 Tel (Technical Service)**

technical.service@hypertherm.com (Technical Service Email)

**800-737-2978 Tel (Customer Service)**

customer.service@hypertherm.com (Customer Service Email)

**866-643-7711 Tel (Return Materials Authorization)**

**877-371-2876 Fax (Return Materials Authorization)**

return.materials@hypertherm.com (RMA email)

**Hypertherm Plasmatechnik GmbH**

Technologiepark Hanau

Rodenbacher Chaussee 6

D-63457 Hanau-Wolfgang, Deutschland

49 6181 58 2100 Tel

49 6181 58 2134 Fax

**49 6181 58 2123 (Technical Service)**

**Hypertherm (S) Pte Ltd.**

82 Genting Lane

Media Centre

Annexe Block #A01-01

Singapore 349567, Republic of Singapore

65 6841 2489 Tel

65 6841 2490 Fax

**65 6841 2489 (Technical Service)**

**Hypertherm (Shanghai) Trading Co., Ltd.**

Unit 301, South Building

495 ShangZhong Road

Shanghai, 200231

PR China

86-21-60740003 Tel

86-21-60740393 Fax

**Hypertherm Europe B.V.**

Vaartveld 9

4704 SE

Roosendaal, Nederland

31 165 596907 Tel

31 165 596901 Fax

31 165 596908 Tel (Marketing)

**31 165 596900 Tel (Technical Service)**

**00 800 4973 7843 Tel (Technical Service)**

**Hypertherm Japan Ltd.**

Level 9, Edobori Center Building

2-1-1 Edobori, Nishi-ku

Osaka 550-0002 Japan

81 6 6225 1183 Tel

81 6 6225 1184 Fax

**Hypertherm Brasil Ltda.**

Rua Bras Cubas, 231 – Jardim Maia

Guarulhos, SP - Brasil

CEP 07115-030

55 11 2409 2636 Tel

55 11 2408 0462 Fax

**Hypertherm México, S.A. de C.V.**

Avenida Toluca No. 444, Anexo 1,

Colonia Olivar de los Padres

Delegación Álvaro Obregón

México, D.F. C.P. 01780

52 55 5681 8109 Tel

52 55 5683 2127 Fax

**Hypertherm Korea Branch**

#3904 Centum Leaders Mark B/D,

1514 Woo-dong, Haeundae-gu, Busan

Korea, 612-889

82 51 747 0358 Tel

82 51 701 0358 Fax



# WARNING!

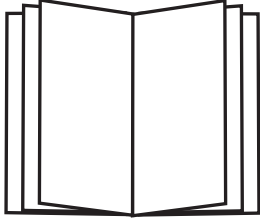

## READ THE SAFETY INFORMATION

Before operating or maintaining any Hypertherm equipment, read the *Safety and Compliance Manual* (80669C) for important safety information.

You can find the *Safety and Compliance Manual* in the “Downloads library” at [www.hypertherm.com](http://www.hypertherm.com).



<b>Electromagnetic Compatibility (EMC)</b> .....	<b>SC-11</b>
Introduction .....	SC-11
Installation and use .....	SC-11
Assessment of area .....	SC-11
Methods of reducing emissions .....	SC-11
Mains supply .....	SC-11
Maintenance of cutting equipment .....	SC-11
Cutting cables .....	SC-11
Equipotential bonding .....	SC-11
Earthing of the workpiece .....	SC-11
Screening and shielding .....	SC-12
<b>Warranty</b> .....	<b>SC-13</b>
Attention .....	SC-13
General .....	SC-13
Patent indemnity .....	SC-13
Limitation of liability .....	SC-13
National and local codes .....	SC-13
Liability cap .....	SC-13
Insurance .....	SC-14
Transfer of rights .....	SC-14
<b>1 Specifications</b> .....	<b>15</b>
Safety information .....	15
System description .....	15
Power supply dimensions .....	16
System weights .....	16
Hypertherm system ratings .....	17

Torch dimensions .....	18
Torch weight .....	18
Cutting specifications .....	18
Symbols and marks .....	19
Noise levels .....	20
IEC symbols .....	20
<b>2 Power Supply Setup .....</b>	<b>21</b>
Unpack the plasma system .....	21
Claims .....	21
System contents .....	22
Position the plasma system .....	23
Prepare the electrical power .....	23
Voltage configurations .....	23
Requirements for grounding .....	24
Power cord considerations .....	24
CSA power cords and plugs .....	24
CE and CCC power cords .....	25
Extension cord recommendations .....	26
Generator recommendations .....	26
Prepare the gas supply .....	27
Connect the gas supply .....	27
Additional gas filtration .....	28
<b>3 Torch Setup .....</b>	<b>29</b>
Introduction .....	29
Hand torch components .....	29
Consumable life .....	30
Choose the consumables .....	30
Using the cut charts .....	32
General-purpose (standard) consumables .....	32
240 V / 30 A cutting .....	33
FineCut consumables .....	34
120 V / 25 A cutting .....	35
120 V / 30 A cutting .....	36
HyAccess consumables .....	37
Cutting at 240 V .....	37
Cutting at 120 V / 20 A .....	37
Ordering and replacing .....	37



- 4 Operation ..... 39**
  - Controls and indicators ..... 39
    - Rear controls ..... 39
    - Front controls and LEDs ..... 40
  - Operate the plasma system ..... 41
    - Connect the electrical power and gas supply ..... 41
  - Install the consumables ..... 42
    - Attach the ground clamp ..... 44
    - Power ON the system ..... 44
    - Adjust the gas pressure and output current ..... 44
      - Operating the system on a 120 V, 15 A circuit ..... 45
      - Operating the system on a 120 V, 20 A circuit ..... 45
      - Operating the system on a 240 V, 20 A circuit ..... 45
    - Check the indicator LEDs ..... 46
    - Verify the system is ready ..... 46
  - Understand duty-cycle limitations ..... 46
  - System operation guidelines ..... 47
  - Hand torch operation ..... 48
    - Safety catch operation ..... 48
    - Hand torch cutting guidelines ..... 49
      - Recommendations for cutting at 120 V ..... 49
    - Edge start on a workpiece ..... 50
    - Pierce a workpiece ..... 51
    - Gouge a workpiece ..... 52
      - Varying the gouge profile ..... 53
    - Common hand-cutting faults ..... 54
      - Minimizing dross ..... 54
  
- 5 Maintenance and Troubleshooting ..... 55**
  - Perform routine maintenance ..... 55
  - Inspect the consumables ..... 57
    - Basic troubleshooting ..... 58
  - Maintenance procedures ..... 61
    - Replace the air filter element and air filter bowl ..... 61
      - Remove the power supply cover and handle ..... 61
      - Remove the old air filter element and air filter bowl ..... 62
      - Install the new air filter element and air filter bowl ..... 63
      - Put the power supply cover and handle back in place ..... 64

- 6 Parts ..... 65**
- Power supply parts ..... 66
  - Exterior, front ..... 66
  - Exterior, rear ..... 67
  - Air filter/regulator with pressure switch assembly (interior, fan side) ..... 68
- Duramax LT hand torch parts ..... 69
- Duramax LT hand torch consumables ..... 70
  - General-purpose (standard) consumables ..... 70
  - FineCut consumables ..... 70
  - HyAccess consumables ..... 71
- Accessory parts ..... 72
- Powermax30 XP labels ..... 73

## Introduction

Hypertherm's CE-marked equipment is built in compliance with standard EN60974-10. The equipment should be installed and used in accordance with the information below to achieve electromagnetic compatibility.

The limits required by EN60974-10 may not be adequate to completely eliminate interference when the affected equipment is in close proximity or has a high degree of sensitivity. In such cases it may be necessary to use other measures to further reduce interference.

This cutting equipment is designed for use only in an industrial environment.

## Installation and use

The user is responsible for installing and using the plasma equipment according to the manufacturer's instructions.

If electromagnetic disturbances are detected then it shall be the responsibility of the user to resolve the situation with the technical assistance of the manufacturer. In some cases this remedial action may be as simple as earthing the cutting circuit, see *Earthing of the workpiece*. In other cases, it could involve constructing an electromagnetic screen enclosing the power source and the work complete with associated input filters. In all cases, electromagnetic disturbances must be reduced to the point where they are no longer troublesome.

## Assessment of area

Before installing the equipment, the user shall make an assessment of potential electromagnetic problems in the surrounding area. The following shall be taken into account:

- a. Other supply cables, control cables, signaling and telephone cables; above, below and adjacent to the cutting equipment.
- b. Radio and television transmitters and receivers.
- c. Computer and other control equipment.
- d. Safety critical equipment, for example guarding of industrial equipment.
- e. Health of the people around, for example the use of pacemakers and hearing aids.
- f. Equipment used for calibration or measurement.
- g. Immunity of other equipment in the environment. User shall ensure that other equipment being used in the environment is compatible. This may require additional protection measures.
- h. Time of day that cutting or other activities are to be carried out.

The size of the surrounding area to be considered will depend on the structure of the building and other activities that are taking place. The surrounding area may extend beyond the boundaries of the premises.

## Methods of reducing emissions

### Mains supply

Cutting equipment must be connected to the mains supply according to the manufacturer's recommendations. If interference occurs, it may be necessary to take additional precautions such as filtering of the mains supply.

Consideration should be given to shielding the supply cable of permanently installed cutting equipment, in metallic conduit or equivalent. Shielding should be electrically continuous throughout its length. The shielding should be connected to the cutting mains supply so that good electrical contact is maintained between the conduit and the cutting power source enclosure.

### Maintenance of cutting equipment

The cutting equipment must be routinely maintained according to the manufacturer's recommendations. All access and service doors and covers should be closed and properly fastened when the cutting equipment is in operation. The cutting equipment should not be modified in any way, except as set forth in and in accordance with the manufacturer's written instructions. For example, the spark gaps of arc striking and stabilizing devices should be adjusted and maintained according to the manufacturer's recommendations.

### Cutting cables

The cutting cables should be kept as short as possible and should be positioned close together, running at or close to the floor level.

### Equipotential bonding

Bonding of all metallic components in the cutting installation and adjacent to it should be considered.

However, metallic components bonded to the workpiece will increase the risk that the operator could receive a shock by touching these metallic components and the electrode (nozzle for laser heads) at the same time.

The operator should be insulated from all such bonded metallic components.

### Earthing of the workpiece

Where the workpiece is not bonded to earth for electrical safety, nor connected to earth because of its size and position, for example, ship's hull or building steel work, a connection bonding the workpiece to earth may reduce emissions in some, but not all instances. Care should be taken to prevent the earthing of the workpiece increasing the risk of injury to users, or damage to other electrical equipment. Where necessary, the connection of the workpiece to earth should be made by a direct connection to the workpiece, but in some countries where direct connection is not permitted, the bonding should be achieved by suitable capacitances selected according to national regulations.

## **Electromagnetic Compatibility (EMC)**

---

Note: The cutting circuit may or may not be earthed for safety reasons. Changing the earthing arrangements should only be authorized by a person who is competent to assess whether the changes will increase the risk of injury, for example, by allowing parallel cutting current return paths which may damage the earth circuits of other equipment. Further guidance is provided in IEC 60974-9, Arc Welding Equipment, Part 9: Installation and Use.

### **Screening and shielding**

Selective screening and shielding of other cables and equipment in the surrounding area may alleviate problems of interference. Screening of the entire plasma cutting installation may be considered for special applications.

## Attention

Genuine Hypertherm parts are the factory-recommended replacement parts for your Hypertherm system. Any damage or injury caused by the use of other than genuine Hypertherm parts may not be covered by the Hypertherm warranty, and will constitute misuse of the Hypertherm Product.

You are solely responsible for the safe use of the Product. Hypertherm does not and cannot make any guarantee or warranty regarding the safe use of the product in your environment.

## General

Hypertherm Inc. warrants that its Products shall be free from defects in materials and workmanship for the specific periods of time set forth herein and as follows: if Hypertherm is notified of a defect (i) with respect to the plasma power supply within a period of two (2) years from the date of its delivery to you, with the exception of Powermax brand power supplies, which shall be within a period of three (3) years from the date of delivery to you, and (ii) with respect to the torch and leads within a period of one (1) year from its date of delivery to you, with the exception of the HPRXD short torch with integrated lead, which shall be within a period of six (6) months from the date of delivery to you, and with respect to torch lifter assemblies within a period of one (1) year from its date of delivery to you, and with respect to Automation products one (1) year from its date of delivery to you, with the exception of the EDGE Pro CNC, EDGE Pro Ti CNC, MicroEDGE Pro CNC, and ArcGlide THC, which shall be within a period of two (2) years from the date of delivery to you, and (iii) with respect to HyIntensity fiber laser components within a period of two (2) years from the date of its delivery to you, with the exception of laser heads and beam delivery cables, which shall be within a period of one (1) year from its date of delivery to you.

This warranty shall not apply to any Powermax brand power supplies that have been used with phase converters. In addition, Hypertherm does not warranty systems that have been damaged as a result of poor power quality, whether from phase converters or incoming line power. This warranty shall not apply to any product which has been incorrectly installed, modified, or otherwise damaged.

Hypertherm provides repair, replacement or adjustment of the Product as the sole and exclusive remedy, if and only if the warranty set forth herein properly is invoked and applies. Hypertherm, at its sole option, shall repair, replace, or adjust, free of charge, any defective Products covered by this warranty which shall be returned with Hypertherm's prior authorization (which shall not be unreasonably withheld), properly packed, to Hypertherm's place of business in Hanover, New Hampshire, or to an authorized Hypertherm repair facility, all costs, insurance and freight pre paid by the customer. Hypertherm shall not be liable for any repairs, replacement, or adjustments of Products covered by this warranty, except those made pursuant to this paragraph and with Hypertherm's prior written consent.

The warranty set forth above is exclusive and is in lieu of all other warranties, express, implied, statutory, or otherwise with respect to the Products or as to the results which may be obtained therefrom, and all implied warranties or conditions of quality or of merchantability or fitness for a particular purpose or against infringement. The foregoing shall constitute the sole and exclusive remedy for any breach by Hypertherm of its warranty.

Distributors/OEMs may offer different or additional warranties, but Distributors/OEMs are not authorized to give any additional warranty protection to you or make any representation to you purporting to be binding upon Hypertherm.

## Patent indemnity

Except only in cases of products not manufactured by Hypertherm or manufactured by a person other than Hypertherm not in strict conformity with Hypertherm's specifications and in cases of designs, processes, formulae, or combinations not developed or purported to be developed by Hypertherm, Hypertherm will have the right to defend or settle, at its own expense, any suit or proceeding brought against you alleging that the use of the Hypertherm product, alone and not in combination with any other product not supplied by Hypertherm, infringes any patent of any third party. You shall notify Hypertherm promptly upon learning of any action or threatened action in connection with any such alleged infringement (and in any event no longer than fourteen (14) days after learning of any action or threat of action), and Hypertherm's obligation to defend shall be conditioned upon Hypertherm's sole control of, and the indemnified party's cooperation and assistance in, the defense of the claim.

## Limitation of liability

**In no event shall Hypertherm be liable to any person or entity for any incidental, consequential direct, indirect, punitive or exemplary damages (including but not limited to lost profits) regardless of whether such liability is based on breach of contract, tort, strict liability, breach of warranty, failure of essential purpose, or otherwise, and even if advised of the possibility of such damages.**

## National and local codes

National and local codes governing plumbing and electrical installation shall take precedence over any instructions contained in this manual. In no event shall Hypertherm be liable for injury to persons or property damage by reason of any code violation or poor work practices.

## Liability cap

**In no event shall Hypertherm's liability, if any, whether such liability is based on breach of contract, tort, strict liability, breach of warranties, failure of essential purpose or otherwise, for any claim, action, suit or proceeding (whether in court, arbitration, regulatory proceeding or otherwise) arising out of or relating to the use of the Products exceed in the aggregate the amount paid for the Products that gave rise to such claim.**

## **Warranty**

---

### **Insurance**

At all times you will have and maintain insurance in such quantities and types, and with coverage sufficient and appropriate to defend and to hold Hypertherm harmless in the event of any cause of action arising from the use of the products.

### **Transfer of rights**

You may transfer any remaining rights you may have hereunder only in connection with the sale of all or substantially all of your assets or capital stock to a successor in interest who agrees to be bound by all of the terms and conditions of this Warranty. Within thirty (30) days before any such transfer occurs, you agree to notify in writing Hypertherm, which reserves the right of approval. Should you fail timely to notify Hypertherm and seek its approval as set forth herein, the Warranty set forth herein shall be null and void and you will have no further recourse against Hypertherm under the Warranty or otherwise.

### Safety information

Before operating any Hypertherm equipment, read the separate *Safety and Compliance Manual* (80669C) included with your product for important safety information.

### System description

The Powermax30 XP is a highly portable, 30 A, handheld plasma cutting system appropriate for a wide range of applications. It uses air or nitrogen to cut electrically conductive metals, such as mild steel, stainless steel, or aluminum. With it you can cut thicknesses up to 16 mm (5/8 inches) and pierce thicknesses up to 6 mm (1/4 inch).

The Powermax30 XP ships in several different configurations, based on region. Typically all configurations include:

- 1 complete set of general-purpose (standard) consumables (preinstalled on the Duramax™ LT hand torch) for standard cutting:
  - 1 electrode
  - 1 swirl ring
  - 1 nozzle
  - 1 retaining cap
  - 1 shield
- 1 extra general-purpose nozzle
- 1 extra electrode
- FineCut® consumables for detailed cutting:
  - 1 FineCut nozzle
  - 1 FineCut deflector
- 1 region-specific air fitting:
  - Industrial interchange quick-disconnect nipple with 1/4 NPT threads (CSA models)
  - British Pipe Thread adapter G-1/4 BSPP with 1/4 NPT threads (CE and CCC models)

## 1 – Specifications

---

- Carrying strap
- Operator Manual
- Safety and Compliance Manual
- Quick Setup Card



For details on how to select the right set of consumables for a given cutting job, see *Choose the consumables* on page 30.

Additional items may also ship with your system depending on the configuration that you ordered, such as instructional setup materials, a carrying case, leather cutting gloves, or protective glasses.

CSA units ship with a 120 V/15 A (NEMA 5-15P) adapter and a 240 V/20 A (NEMA 6-50P) adapter that connect to the NEMA twist lock-style 240 V/20 A (NEMA L6-20P) plug wired to the power supply. CE and CCC units ship without a plug on the power cord. See *Power cord considerations* on page 24 for more information.

You can order additional consumables and accessories – such as specialty consumables, a carrying strap, and a circle cutting guide – from any Hypertherm distributor. See the *Parts* section on page 65 for a list of spare and optional parts.

### Power supply dimensions

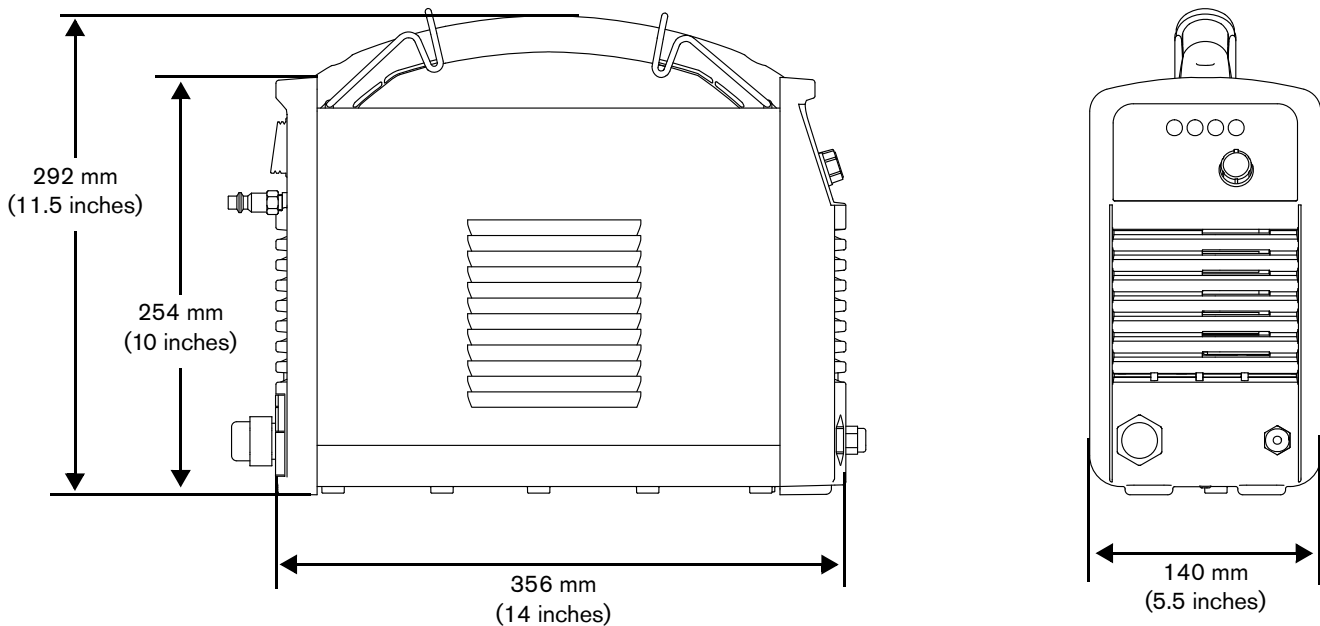

### System weights

The following system weights include the hand torch with 4.6 m (15 foot) torch lead, a 4.6 m (15 foot) work lead with ground clamp, and a 3.0 m (10 foot) power cord:

- CSA systems: 9.7 kg (21.4 pounds)
- CE and CCC systems: 9.5 kg (21.0 pounds)



## Hypertherm system ratings

Rated open circuit voltage ( $U_0$ )	256 VDC	
Rated output current ( $I_2$ )	15 A to 30 A	
Rated output voltage ( $U_2$ ) at $U_1 = 120$ VAC	83 VDC	
Rated output voltage ( $U_2$ ) at $U_1 = 200 - 240$ VAC	125 VDC	
Duty cycle at 40°C, $U_1 = 120$ VAC (See data plate on power supply for more information on duty cycle and for IEC ratings.)	20% ( $I_2 = 30$ A, $U_2 = 83$ V) 60% ( $I_2 = 17$ A, $U_2 = 83$ V) 100% ( $I_2 = 15$ A, $U_2 = 83$ V)	
Duty cycle at 40°C, $U_1 = 200 - 240$ VAC (See data plate on power supply for more information on duty cycle and for IEC ratings.)	35% ( $I_2 = 30$ A, $U_2 = 125$ V) 60% ( $I_2 = 23$ A, $U_2 = 125$ V) 100% ( $I_2 = 18$ A, $U_2 = 125$ V)	
Operating temperature	-10° to 40° C (14° to 104° F)	
Storage temperature	-25° to 55° C (-13° to 131° F)	
Power factor (120 V – 240 V)	0.99 – 0.97	
Input voltage ( $U_1$ )/ Input current ( $I_1$ ) at rated output ( $U_{2\text{ MAX}}$ , $I_{2\text{ MAX}}$ ) (See <i>Voltage configurations</i> on page 23 for more information.)	120 V, 1-phase, 50/60 Hz, 25 A 200 – 240 V, 1-phase, 50/60 Hz, 22.5 – 18.8 A	
Gas type	Air	Nitrogen
Gas quality	Clean, dry, oil-free	99.995% pure
Minimum required gas inlet flow and pressure	99.1 L/min at 4.7 bar (3.5 scfm at 68 psi)	
Recommended gas inlet flow and pressure	113.3 L/min at 5.5 bar (4.0 scfm at 80 psi)	
Maximum gas inlet pressure	9.3 bar (135 psi)	

## 1 – Specifications

### Torch dimensions

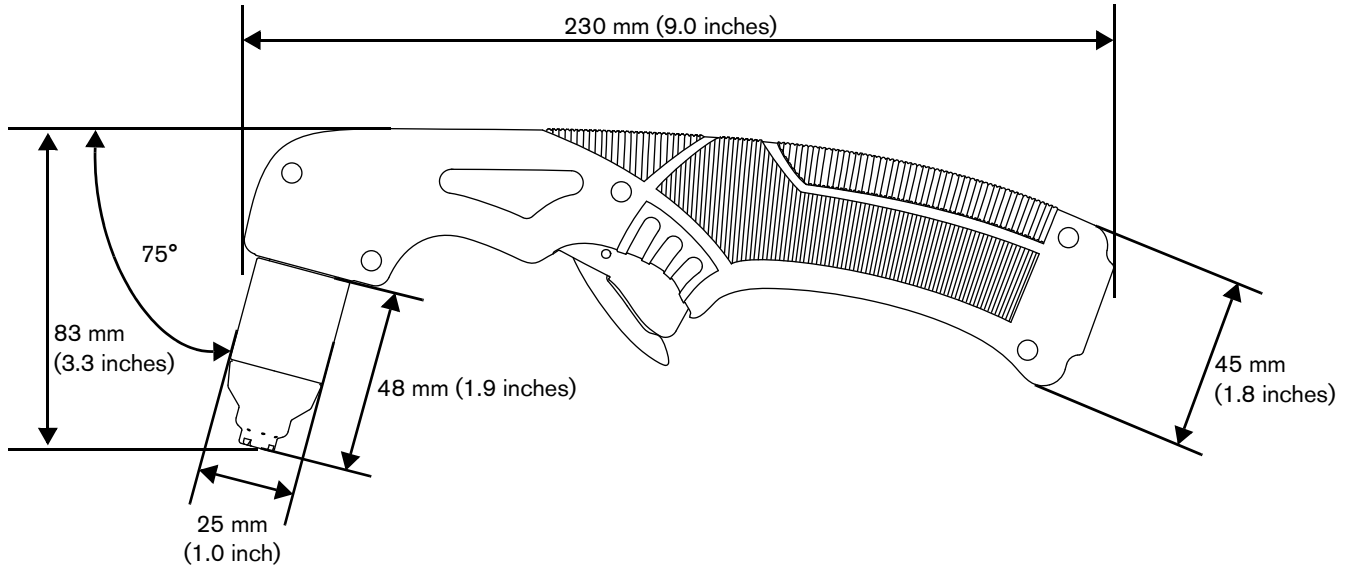

### Torch weight

Hand torch with general-purpose (standard) consumables only	0.3 kg (0.75 pounds)
Hand torch with general-purpose (standard) consumables and 4.6 m (15 foot) lead (with strain relief)	1.1 kg (2.35 pounds)

### Cutting specifications

240 V (with general-purpose [standard] consumables)	
Recommended cut capacity	10 mm (3/8 inch) at 500 mm/minute (20 inches/minute) 12 mm (1/2 inch) at 250 mm/minute (10 inches/minute)
Severance cut capacity	16 mm (5/8 inch) at 125 mm/minute (5 inches/minute)

**120 V:** Use the FineCut nozzle and deflector for cutting on 120 V input circuits. When you operate the system at the maximum recommended output of 25 A, the cut capacities are:

- ❑ 6 mm (1/4 inch) at 480 mm/minute (19 inches/minute)
- ❑ 10 mm (3/8 inch) at 200 mm/minute (8 inches/minute)
- ❑ 12 mm (1/2 inch) at 75 mm/minute (3 inches/minute)



To understand the differences between the general-purpose and FineCut consumables, and for guidelines on selecting the right set for your cutting applications, see *Choose the consumables* on page 30.

## Symbols and marks

Your product may have one or more of the following markings on or near the data plate. Due to differences and conflicts in national regulations, not all marks are applied to every version of a product.



### S mark

The S mark indicates that the power supply and torch are suitable for operations carried out in environments with increased hazard of electrical shock according to IEC 60974-1.



### CSA mark

Products with a CSA mark meet the United States and Canadian regulations for product safety. The products were evaluated, tested, and certified by CSA-International. Alternatively, the product may have a mark by one of the other Nationally Recognized Testing Laboratories (NRTL) accredited in both the United States and Canada, such as UL or TÜV.



### CE mark

The CE marking signifies the manufacturer's declaration of conformity to applicable European directives and standards. Only those versions of products with a CE marking located on or near the data plate have been tested for compliance with the European Low Voltage Directive and the European Electromagnetic Compatibility (EMC) Directive. EMC filters needed to comply with the European EMC Directive are incorporated within versions of the product with a CE marking.



### Eurasian Customs Union (CU) mark

CE versions of products that include an EAC mark of conformity meet the product safety and EMC requirements for export to Russia, Belarus, and Kazakhstan.



### GOST-TR mark

CE versions of products that include a GOST-TR mark of conformity meet the product safety and EMC requirements for export to the Russian Federation.



### C-Tick mark

CE versions of products with a C-Tick mark comply with the EMC regulations required for sale in Australia and New Zealand.



### CCC mark

The China Compulsory Certification (CCC) mark indicates that the product has been tested and found compliant with product safety regulations required for sale in China.



### UkrSEPRO mark

The CE versions of products that include a UkrSEPRO mark of conformity meet the product safety and EMC requirements for export to the Ukraine.



### Serbian AAA mark

CE versions of products that include a AAA Serbian mark meet the product safety and EMC requirements for export to Serbia.

# 1 – Specifications

---

## Noise levels

This plasma system may exceed acceptable noise levels as defined by national and local codes. Always wear proper ear protection when cutting. Any noise measurements taken depend on the specific environment in which the system is used. Refer to *Noise can damage hearing* in the *Safety and Compliance Manual (80669C)* included with your system.

In addition, you can find an *Acoustical Noise Data Sheet* for your system in the Hypertherm downloads library at <http://www.hypertherm.com>:

1. Click “Downloads library.”
2. Select a product from the “Product type” menu.
3. Select “Regulatory” from the “Category” menu.
4. Select “Acoustical Noise Data Sheets” from the “Sub Category” menu.

## IEC symbols

The following symbols may appear on the power supply data plate, control labels, switches, and LEDs.



Direct current (DC)



Alternating current (AC)



Plasma torch cutting



AC input power connection



The terminal for the external protective (earth) conductor



Power is ON



Power is OFF



An inverter-based power source



Volt/amp curve, “drooping” characteristic



Power is ON (LED)



Inlet gas pressure fault (LED)



Missing or loose consumables (LED)



Power supply is overheated (LED)

## Section 2

### Power Supply Setup

---

#### Unpack the plasma system

1. Verify that you received all items on your order in good condition. Contact your distributor if any parts are damaged or missing. (See *System contents* on page 22.)
2. Inspect the system for damage that may have occurred during shipment. If you find evidence of damage, refer to *Claims*. All communications regarding this equipment must include the model number and the serial number located on the bottom of the power supply.
3. Before you set up and operate this system, read the separate *Safety and Compliance Manual* (80669C) included with your system for important safety information.

#### Claims

- **Claims for damage during shipment** – If your unit was damaged during shipment, file a claim with the carrier. You can contact Hypertherm for a copy of the bill of lading. If you need additional assistance, call the nearest Hypertherm office listed in the front of this manual.
- **Claims for defective or missing merchandise** – If any component is missing or defective, contact your Hypertherm distributor. If you need additional assistance, call the nearest Hypertherm office listed in the front of this manual.

### System contents

The following illustration shows the components typically included with all system configurations. Additional components – such as setup instructions, a carrying case and protective glasses and gloves – may also be included with your system, depending on the configuration you ordered.

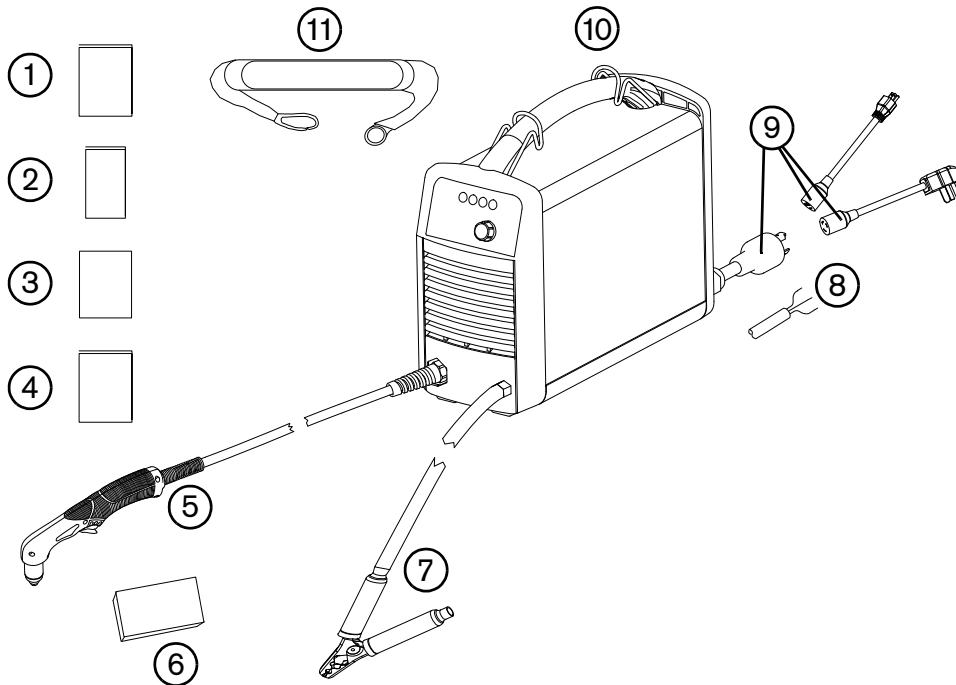



- |   |                              |    |  |
|---|------------------------------|----|--|
| 1 | Operator Manual              | 7  | Ground clamp and work lead                 |
| 2 | Quick Setup Card             | 8  | CE/CCC power cord (no power plug included) |
| 3 | Registration card            | 9  | CSA power cord with power plug adapters    |
| 4 | Safety and Compliance Manual | 10 | Power supply                               |
| 5 | Hand torch with lead         | 11 | Carrying strap                             |
| 6 | Consumable kit               |    |  |



The specific components included with the system are subject to change over time.

## Position the plasma system

- Position the plasma system near an appropriate power receptacle. The system has a 3.0 m (10 foot) power cord.
- Allow at least 0.25 m (10 inches) of space around the power supply for proper ventilation.
- Place the power supply on a stable, level surface before using. To avoid toppling, do not set the power supply on an incline greater than 10 degrees.
- Do not use the system in rain or snow.

		<b>WARNING!</b>
<b>Never cut under water or submerge the torch in water.</b>		

## Prepare the electrical power

The system's maximum output voltage varies based on the input voltage and the circuit's amperage.

Additional factors must be considered when you are operating the system at an input power of 120 V, as tripped circuit breakers can result under some conditions. For more information, see *System operation guidelines* on page 47 and *Basic troubleshooting* on page 58.

### Voltage configurations

The system automatically adjusts for proper operation at the current input voltage without requiring you to perform any switching or rewiring. However, you must set the amperage adjustment knob to an appropriate output current and verify that an appropriate set of consumables is properly installed in the torch. For more information, see *Adjust the gas pressure and output current* on page 44 and *Install the consumables* on page 42.

The following table shows the maximum rated output for typical combinations of input voltage and amperage. The output setting you need to use depends on the thickness of the metal and is limited by the input power to your system.

Input voltage circuit*	Rated output	Input current at rated output	kVA	Recommended consumables†
120 V, 15 A	20 A, 83 V	16.4 A	2.0	FineCut
120 V, 20 A	25 A, 83 V	20.5 A	2.5	FineCut
120 V, 30 A	30 A, 83 V	25 A	3.0	FineCut
200 V – 240 V, 20 A	30 A, 125 V	22.5 A – 18.8 A	4.5	General-purpose or FineCut

\* Input voltages can be  $\pm 10\%$  of the values in this table.

† See *Choose the consumables* on page 30 for an explanation of general-purpose (standard) and FineCut consumables.



### CAUTION!

**A circuit capable of 20 A/120 V or 20 A/240 V is required for proper operation. Protect the circuit with appropriately sized slow-blow (time-delay) fuses or circuit breakers.**

### Requirements for grounding

Properly ground the system as follows to ensure personal safety, proper operation, and to reduce electromagnetic interference (EMI):

- The system must be grounded through the power cord according to national and local electrical codes.
- Single-phase service must be of the three-wire type with a green (CSA) or green/yellow (CE/CCC) wire for the protective earth ground and must comply with national and local requirements. **Do not use a two-wire service.**
- Refer to the *Safety and Compliance Manual (80669C)* for more information.

### Power cord considerations

This system ships with a CSA, CE, or CCC power cord configuration. See *Exterior, rear* on page 67 for part number information.

### CSA power cords and plugs

CSA configurations include the following plug and adapters.

- The power cord is equipped with a NEMA twist lock-style plug (NEMA L6-20P) appropriate for use on a 240 V/20 A circuit with a NEMA twist lock-style outlet.
- To operate the system on a lower amperage circuit, attach the female end of the 120 V/15 A (NEMA 5-15P) plug adapter to the power supply's NEMA twist lock-style plug.
- Do not set the amperage adjustment knob above 20 A, or you may trip the circuit breaker. See *Adjust the gas pressure and output current* on page 44.
- To operate the system on a 240 V/20 A circuit, attach the female end of the 240 V/20 A (NEMA 6-50P) plug to the power supply's NEMA twist lock-style plug.

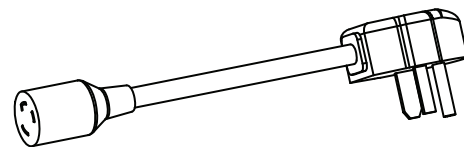
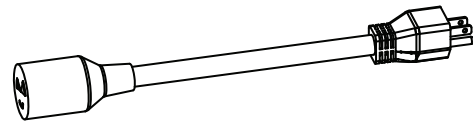
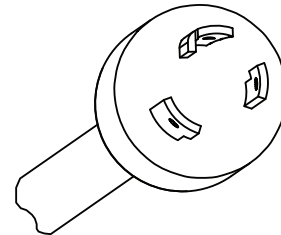



### CE and CCC power cords

CE and CCC configurations ship without a plug on the power cord. To operate at 220 V (CCC) or 230 V (CE), obtain the correct plug for your unit and location and have it installed by a licensed electrician.

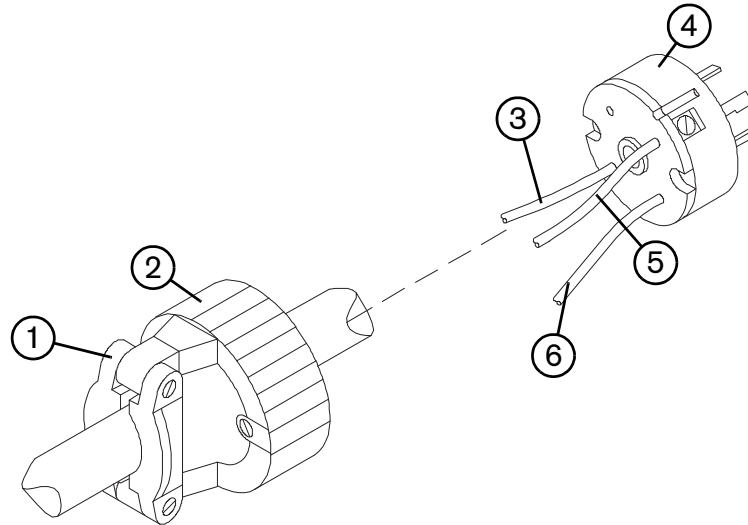

- |   |                            |   |                                   |
|---|----------------------------|---|-----------------------------------|
| 1 | Cord grip                  | 4 | 220 V (CCC) or 230 V (CE) plug    |
| 2 | Outer shell                | 5 | To line 2 terminal (blue)         |
| 3 | To line 1 terminal (brown) | 6 | To ground terminal (green/yellow) |

1. Strip back the cord insulation to separate wires 3, 5, and 6.
2. Remove each wire's insulation to allow good contact with the plug terminals.
3. Make the connections.
4. Reinstall the outer shell and cord grip, and tighten the cord grip's screws until snug. Do not overtighten.

## 2 – Power Supply Setup

### Extension cord recommendations

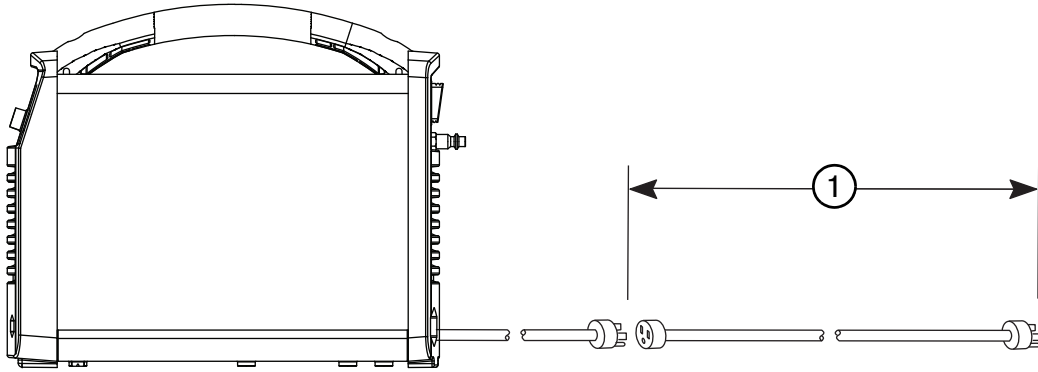

Use an extension cord of an appropriate wire gauge for the cord length and system voltage. Use a cord that meets national and local codes.

Input voltage	Phase	①	
		Recommended cord gauge size	Length
120 VAC	1	4 mm <sup>2</sup> (12 AWG)	Up to 16 m (53 feet)
240 VAC	1	2 mm <sup>2</sup> (14 AWG)	Up to 40.5 m (133 feet)

 Extension cords can cause the machine to receive less input voltage than the output of the circuit. This can limit the operation of your system.

### Generator recommendations

Generators used with this system should produce 240 VAC.

Engine drive rating	Engine drive output current 1-phase (CSA/CE/CCC)	Performance (arc stretch)
5.5 kW	30 A	Full
4 kW	25 A	Limited

 Adjust the cutting current as needed based on the generator rating, age, and condition.

 If a fault occurs while using a generator, turn OFF the system and wait approximately 60 seconds before turning it ON again. Turning the power switch quickly to OFF and ON again (called a "quick reset") may not clear the fault.

### Prepare the gas supply

The gas supply can be shop-compressed or cylinder-compressed. You must use a high-pressure regulator on either type of supply, and the regulator must deliver gas to the filter on the power supply at 99.1 l/min at 4.7 bar (3.5 scfm at 68 psi). To ensure adequate pressure to the power supply, set the regulator between 5.5 and 6.9 bar (80 and 100 psi).

The system contains an internal filter element, but additional filtration may be required depending on the quality of the gas supply. If gas supply quality is poor, cut speeds decrease, cut quality deteriorates, cutting thickness capability decreases, and the life of the consumables shortens. To address these issues, use an optional air filtration system, such as the Hypertherm Eliminer filter kit (128647). For optimal performance, the gas should have a maximum:

- Particle size of 0.1 micron at a maximum concentration of 0.1 mg/m<sup>3</sup>
- Dew point of -40° C (-40° F)
- Oil concentration of 0.1 mg/m<sup>3</sup> (per ISO 8573-1 Class 1.2.2)

### Connect the gas supply

Connect the gas supply to the power supply using an inert gas hose with a 6.3 mm (1/4 inch) or greater internal diameter and an industrial interchange quick-disconnect coupler (for CSA models) or a G-1/4 BSPP threaded coupling (for CE and CCC models).



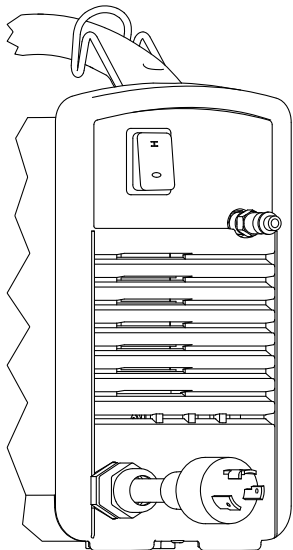

#### CAUTION!

**Some air compressors use synthetic lubricants containing esters that damage the polycarbonates used in the air filter bowl.**



The recommended inlet pressure while gas is flowing is 5.5 – 6.9 bar (80 – 100 psi).

	<b>WARNING!</b>
	The air filter bowl may explode if the gas supply pressure exceeds 9.3 bar (135 psi).

### Additional gas filtration

When site conditions introduce moisture, oil, or other contaminants into the gas line, use a three-stage coalescing filtration system. A three-stage filtering system works as follows to clean contaminants from the gas supply.

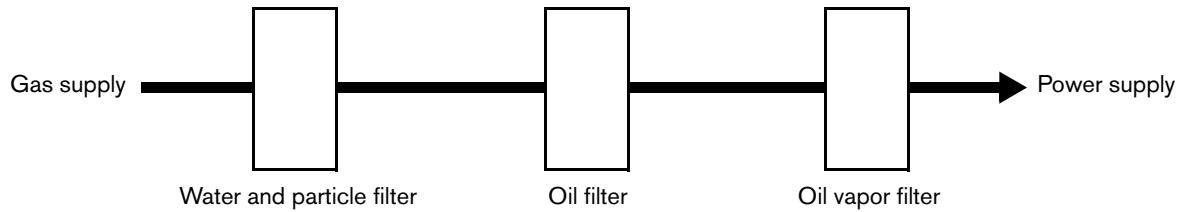

Install the filtering system between the quick-disconnect coupler and the power supply.

## Introduction

The Powermax30 XP includes the Duramax LT hand torch. This section explains how to set up and operate your torch. To achieve optimal consumable life and cut quality, follow the instructions in this manual.

### Hand torch components

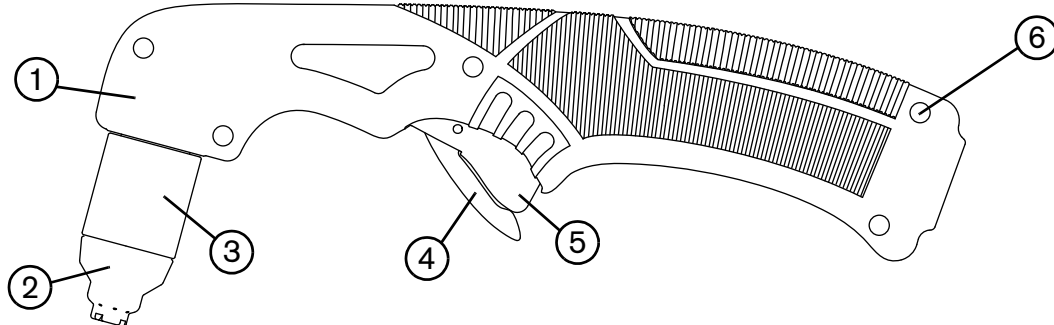

- |                               |                 |
|-------------------------------|-----------------|
| 1 Handle                      | 4 Safety catch  |
| 2 Shield (shown) or deflector | 5 Trigger (red) |
| 3 Retaining cap               | 6 Screws (5)    |

## Consumable life

Consumable life varies based on the following factors:

- Thickness of the metal
- Length of the average cut
- Gas supply quality (presence of oil, moisture, or other contaminants)
- Type of cutting (piercing decreases life when compared to edge cutting)
- Pierce height
- Type of consumable (FineCut, general-purpose, or HyAccess™)



Hypertherm does not recommend the use of any other consumables in this hand torch except for those listed in this section, which are designed specifically for this system. The use of any other consumables could adversely affect system performance.

Although largely dependent on the factors listed above, as a general rule, general-purpose and FineCut consumables last approximately 1 to 2 hours of actual “arc on” time.

HyAccess consumables are specialty consumables that can be ordered separately. You can typically expect them to last half as long as the general-purpose consumables while delivering the same cut quality. See *HyAccess consumables* on page 37.

See *Inspect the consumables* on page 57 for information on the signs of wear to look for in consumables.



If the consumables' life is shorter than expected or the cut quality is poor, verify that you are using the correct combination of consumables. (See the following topic, *Choose the consumables*.) Under normal conditions, the nozzle wears out first.



For optimal cutting performance, always replace the nozzle and the electrode together.

See *Hand torch operation* on page 48 for more information about proper cutting techniques.

## Choose the consumables

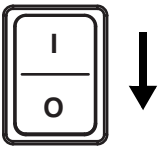
		<b>WARNING!</b> <b>INSTANT-ON TORCHES</b> <b>PLASMA ARC CAN CAUSE INJURY AND BURNS</b>
	<b>The plasma arc ignites immediately when you press the torch trigger. Make sure the power is OFF before changing consumables.</b>	

The hand torch ships with general-purpose (standard) consumables installed. The general-purpose consumables are designed for a broad range of cutting applications.

Also included with your system is at least one FineCut nozzle and deflector. The FineCut consumables are designed to achieve more finely detailed results on thin gauge metal.

 The retaining cap, swirl ring, and electrode are the same for the general-purpose and FineCut consumables. The HyAccess consumables share the same swirl ring but use a unique nozzle, electrode, and retaining cap.

The consumables that you choose should be determined by the:

- Input power
- Amperage output setting
- Thickness of the metal you plan to cut

The amperage output setting you need to use depends on the thickness of the metal you are planning to cut and is limited by the input power to your system. See *Voltage configurations* on page 23.

**Although the visual differences between the general-purpose (standard) and FineCut consumable parts are minor, installing the wrong combination of consumables will affect the life of the parts as well as the cut quality.**

 Hypertherm does not recommend the use of any other consumables in this hand torch except for those listed in this section, which are designed specifically for this system. The use of any other consumables could adversely affect system performance.

Figure 1 and Figure 2 illustrate the differences between the general-purpose and FineCut nozzles and between the deflector and the shield. The FineCut consumables have rings or grooves etched onto them (as shown in Figure 2) to help you distinguish them from the general-purpose consumables.

**Figure 1 – General-purpose (standard)**



**Figure 2 – FineCut**



## 3 – Torch Setup

---

### Using the cut charts

The following topics provide cut charts for each set of consumables. Use these cut charts to guide you in selecting the consumables and cutting current based on the thickness and type of the metal you need to cut.

The maximum cut speeds listed in the cut charts are the fastest possible speeds to cut metal without regard to cut quality. Adjust the cutting speed for your application to obtain the desired cut quality.

When cutting thin metal – 3 mm (10 gauge) or thinner – you may achieve a higher cut quality by using the FineCut consumables and cut charts.

### General-purpose (standard) consumables

Use the general-purpose (or standard) consumables to cut thicker metals that do not require cuts that are as finely detailed. (See *Voltage configurations* on page 23 and *System operation guidelines* on page 47.) This set includes an electrode, swirl ring, general-purpose nozzle, retaining cap, and shield. The general-purpose nozzle must be installed only with the general-purpose shield, not the deflector.

Cutting at 120 V with the general-purpose consumables is not recommended.

**Figure 3 – General-purpose (standard) consumable set**

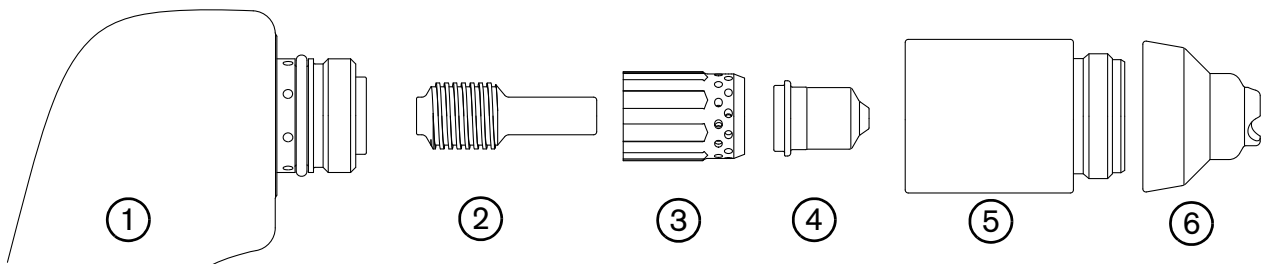

- |                       |                          |
|-----------------------|--------------------------|
| 1 Torch               | 4 Nozzle (420118)*       |
| 2 Electrode (420120)* | 5 Retaining cap (420114) |
| 3 Swirl ring (420211) | 6 Shield (420116)        |

\* You can order packs of nozzles or electrodes, or you can order them combined as a kit. To order a kit of 2 general-purpose (standard) nozzles with 2 electrodes, use kit number **428243**. Hypertherm recommends replacing the nozzle and electrode at the same time.



## 240 V / 30 A cutting

General-purpose (standard) consumables

**Metric**

Material thickness (mm)	Material	Arc current (A)	Maximum cut speed (mm/minute)
1	Mild steel	30	10160 <sup>†</sup>
2			7530
3			4185
5			1835
8*			780
12*			320
16*			175
1	Stainless steel	30	8355
2			5635
3			2910
5			1245
8*			575
10*			360
13*			215
3	Aluminum	30	3555
5			2115
8*			785
10*			425
13*			205

**English**

Material thickness (gauge/inches)	Material	Arc current (A)	Maximum cut speed (inches/minute)
18 GA	Mild steel	30	400 <sup>†</sup>
10 GA			110
1/4			40
3/8*			22
1/2*			10
5/8*			7
18 GA	Stainless steel	30	306
10 GA			70
1/4			31
3/8*			15
1/2*			9
1/8	Aluminum	30	135
1/4			45
3/8*			18
1/2*			9

\* To cut material thicker than 6 mm (1/4 inch), start the torch at the edge of the workpiece.

† Maximum cut speed is limited by the test table's maximum speed (10160 mm/minute or 400 inches/minute).

#### FineCut consumables

Use the FineCut consumables for detailed cutting on thin gauge metal. The FineCut consumable set uses a FineCut nozzle and a deflector with the same electrode, swirl ring, and retaining cap used in the general-purpose consumable set.

The FineCut nozzle must be installed only with the deflector, not the shield. Using the shield results in poor cut quality and increased power demand because the torch-to-work distance is too great.

For guidelines on cutting with 120 V input, see *Recommendations for cutting at 120 V* on page 49.

**Figure 4 – FineCut consumable set**

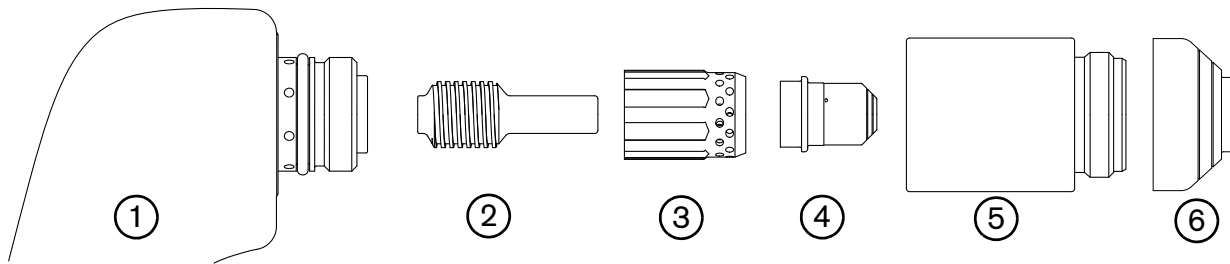

- |                       |                          |
|-----------------------|--------------------------|
| 1 Torch               | 4 Nozzle (420117)*       |
| 2 Electrode (420120)* | 5 Retaining cap (420114) |
| 3 Swirl ring (420211) | 6 Deflector (420115)     |

\* You can order packs of nozzles or electrodes, or you can order them combined as a kit. To order a set of 2 FineCut nozzles with 2 electrodes, use kit number **428244**. Hypertherm recommends replacing the nozzle and electrode at the same time.

## 120 V / 25 A cutting

### FineCut consumables

**Metric**

Material thickness (mm)	Material	Arc current (A)	Maximum cut speed (mm/minute)
1	Mild steel	25	10160 <sup>†</sup>
2			3570
3			1745
5			905
6			590
7*			280
1			Stainless steel
2	2860		
3	1500		
5	825		
6	515		
7*	205		
1	Aluminum	25	
2			5130
3			2170
5			920
7*			120

**English**

Material thickness (gauge/inches)	Material	Arc current (A)	Maximum cut speed (inches/minute)
18 GA	Mild steel	25	330
16 GA			205
14 GA			150
12 GA			80
10 GA			55
1/4			19
18 GA	Stainless steel	25	260
16 GA			160
14 GA			120
12 GA			65
10 GA			52
1/4			16
1/25	Aluminum	25	400 <sup>†</sup>
1/16			250
1/8			65
1/4			15

\* To cut material thicker than 6 mm (1/4 inch), start the torch at the edge of the workpiece.

† Maximum cut speed is limited by the test table's maximum speed (10160 mm/minute or 400 inches/minute).

### 3 – Torch Setup

## 120 V / 30 A cutting

FineCut consumables

#### Metric

Material thickness (mm)	Material	Arc current (A)	Maximum cut speed (mm/minute)
1	Mild steel	30	10160 <sup>†</sup>
2			6175
3			2420
5			1300
8*			535
10*			280
13*			110
1	Stainless steel	30	10025
2			5755
3			2045
5			1135
8*			410
10*			170
1	Aluminum	30	10160 <sup>†</sup>
2			6805
3			3285
5			1455
8*			375
10*			150

#### English

Material thickness (gauge/inches)	Material	Arc current (A)	Maximum cut speed (inches/minute)
22 GA	Mild steel	30	400 <sup>†</sup>
18 GA			400 <sup>†</sup>
12 GA			112
10 GA			75
1/4			31
3/8*			12
1/2*			5
22 GA	Stainless steel	30	400 <sup>†</sup>
18 GA			390
12 GA			90
10 GA			69
1/4			24
3/8*			9
1/25	Aluminum	30	400 <sup>†</sup>
1/16			325
1/8			105
1/4			22
3/8*			8

\* To cut material thicker than 6 mm (1/4 inch), start the torch at the edge of the workpiece.

† Maximum cut speed is limited by the test table's maximum speed (10160 mm/minute or 400 inches/minute).

## HyAccess consumables

You can use HyAccess consumables with your hand torch to achieve greater reach and visibility. HyAccess consumables extend the reach of the general-purpose (standard) consumables by approximately 7.5 cm (3 inches).

 HyAccess consumables do not ship with the system. They are specialty consumables that can be ordered separately.

### Cutting at 240 V

Operating at 240 V, you can expect to achieve approximately the same cut thicknesses and cut quality as with the general-purpose consumables. You may need to reduce your cut speed slightly to achieve the same cut quality.

### Cutting at 120 V / 20 A

If you are operating the system on a 120 V / 20 A circuit, you can use the HyAccess consumables to cut thicknesses up to 3 mm (10 GA).

 Hypertherm does not recommend using the HyAccess consumables when you operate the system on a 120 V / 15 A circuit.

### Ordering and replacing

Typically, you can expect HyAccess consumables to last about half as long as the general-purpose (standard). See *HyAccess consumables* on page 71 for the part numbers to order HyAccess consumables.

Two HyAccess nozzles are available:

- One standard nozzle designed for a broad range of cutting applications
- One gouging nozzle designed specifically for gouging

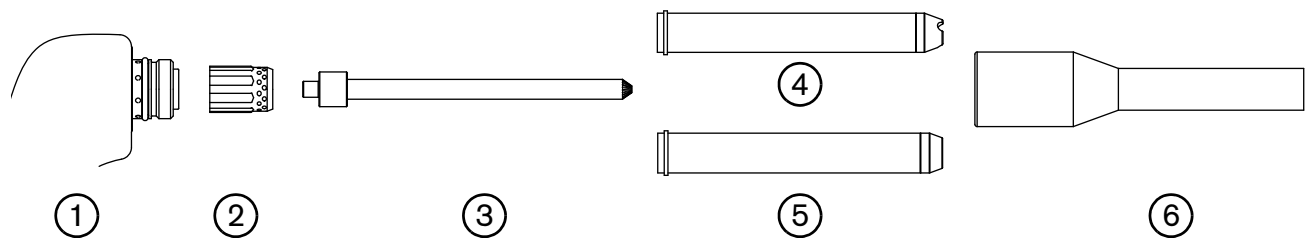

When the tip of either nozzle wears out, replace the entire nozzle.

**Figure 5 – HyAccess consumables**



- 1 Torch
- 2 Swirl ring
- 3 Electrode

- 4 Standard nozzle
- 5 Gouging nozzle
- 6 Retaining cap

		<b>WARNING!</b> <b>CHANCE OF ELECTRIC SHOCK</b>
	<p>Replace the retaining cap immediately if the end of the cap becomes torn or frayed. Touching an exposed nozzle when operating the system will result in electric shock.</p>	

## Controls and indicators

Refer to the following topics to become familiar with the controls and LED indicators on the system before you begin cutting.

### Rear controls

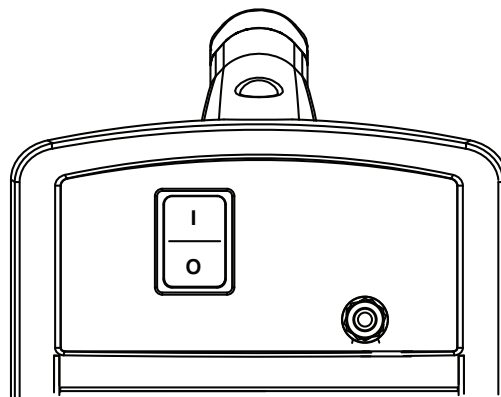

**ON (I) / OFF (O) power switch** – Activates the system and its control circuits.

### Front controls and LEDs

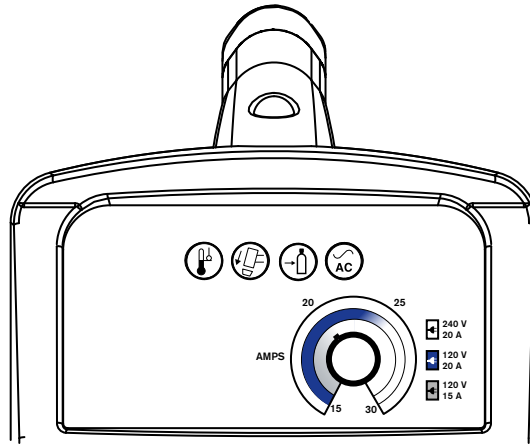

**Power ON LED (green)** – When illuminated, this LED indicates that the power switch has been set to ON (I) and that the safety interlocks are satisfied.



**Gas pressure LED (yellow)** – When illuminated, this LED indicates that the inlet gas pressure is below 2.8 bar (40 psi).



**Torch cap LED (yellow)** – When illuminated, this LED indicates that the consumables are loose, improperly installed, or missing.



**Temperature LED (yellow)** – When illuminated, this LED indicates that the system's temperature is outside the acceptable operating range.



Some fault conditions cause one or more of the LEDs to blink. For information on what these fault conditions are and how to clear them, see *Basic troubleshooting* on page 58.

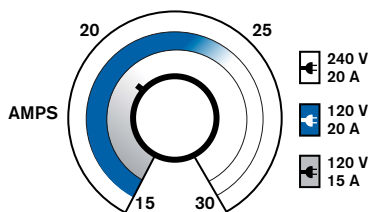

**Amperage adjustment knob** – Use this knob to set the output current between 15 A and 30 A.



## Operate the plasma system

The following topics explain how to begin cutting with the plasma system.

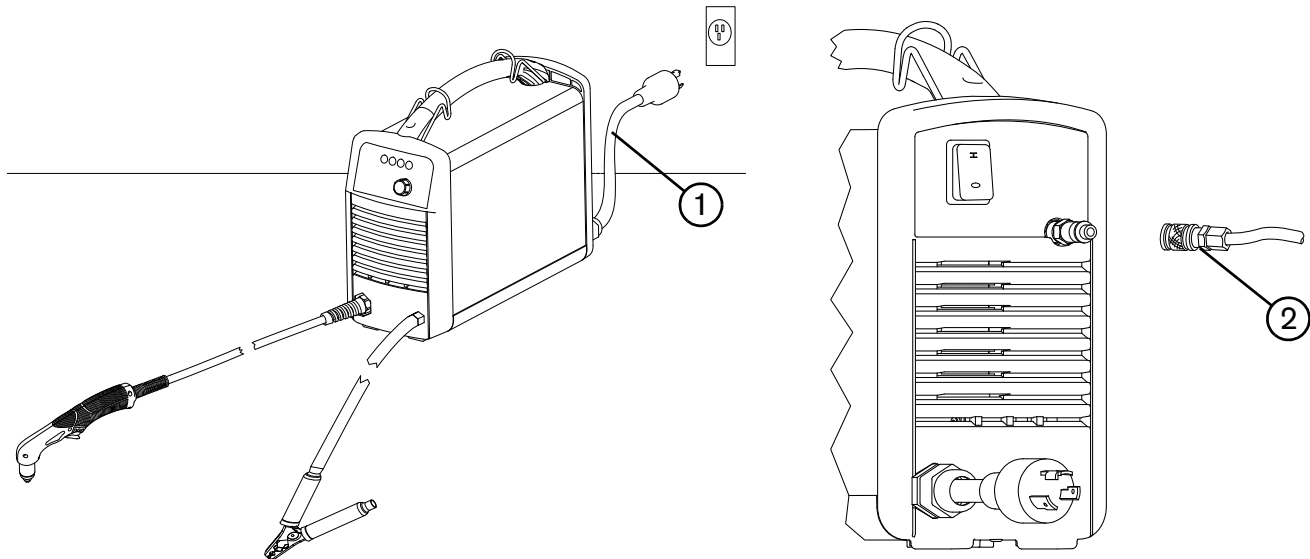

### Connect the electrical power and gas supply

Plug in the power cord ① and connect the gas supply line ②.



- For information on connecting the gas supply to the power supply, see *Prepare the gas supply* on page 27.
- For information on connecting the proper plug to the power cord, see *Power cord considerations* on page 24.
- To understand which consumables to use and what cutting capacity to expect based on input voltage, see *Choose the consumables* on page 30.
- For information on electrical requirements and gas supply requirements for this system, see *Power Supply Setup* on page 21.

### Install the consumables

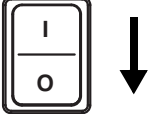
		<p style="text-align: center;"><b>WARNING!</b> <b>INSTANT-ON TORCHES</b> <b>PLASMA ARC CAN CAUSE INJURY AND BURNS</b></p>
	<p><b>The plasma arc ignites immediately when you press the torch trigger. Make sure the power is OFF before changing consumables.</b></p>	

To operate the Duramax LT torch, first verify:

1. The power switch is in the OFF (●) position.
2. A complete set of consumables is installed as shown in Figure 6.
3. You use only the general-purpose shield (420116) with the general-purpose (standard) nozzle (420118).



To understand the differences between the general-purpose and FineCut consumables, and for guidelines on selecting the right set for your cutting applications, see *Choose the consumables* on page 30.

Figure 6

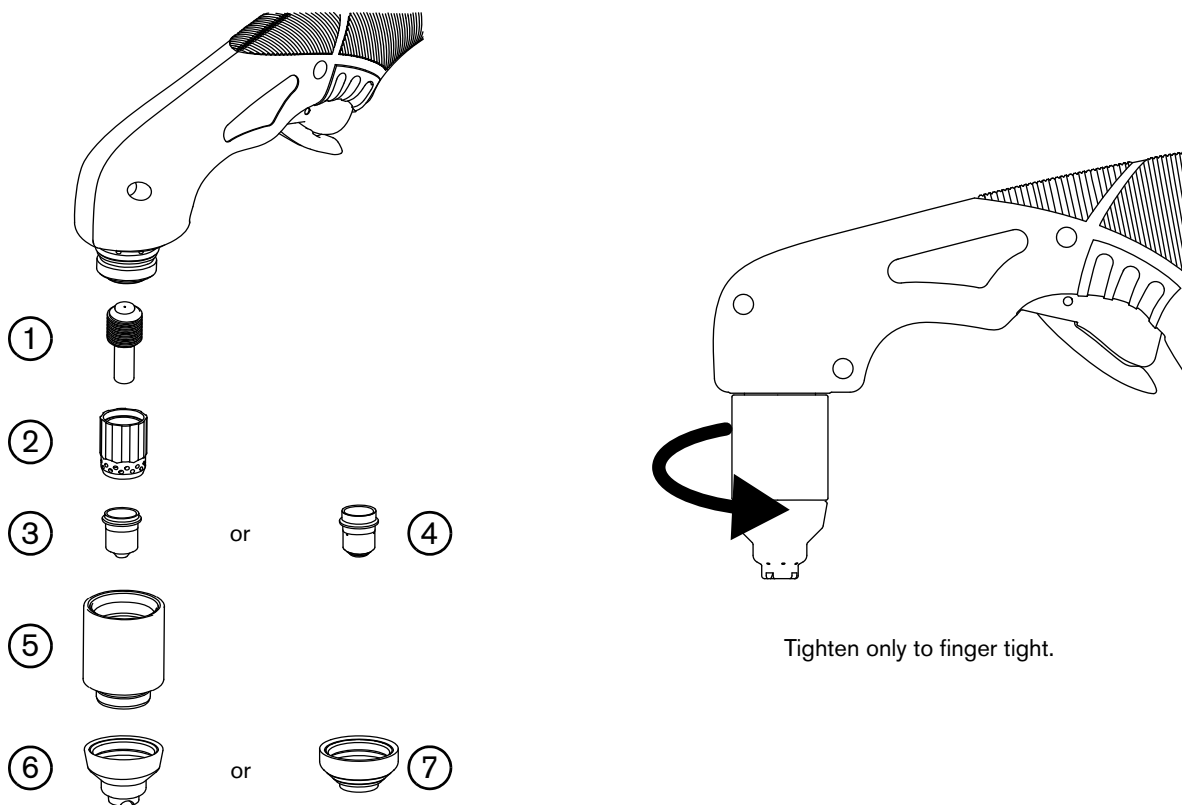

- 1 Electrode
- 2 Swirl ring
- 3 Nozzle (general-purpose)
- 4 Nozzle (FineCut)

- 5 Retaining cap
- 6 Shield (general-purpose)
- 7 Deflector (FineCut)

### Attach the ground clamp

Attach the ground clamp to the workpiece.

- Verify that the ground clamp and the workpiece make good metal-to-metal contact.
- Attach the ground clamp as close as possible to the area being cut to reduce exposure to electric and magnetic fields (EMF) and to achieve the best possible cut quality.
- **Do not attach the ground clamp to the portion of the workpiece that you are cutting away.**

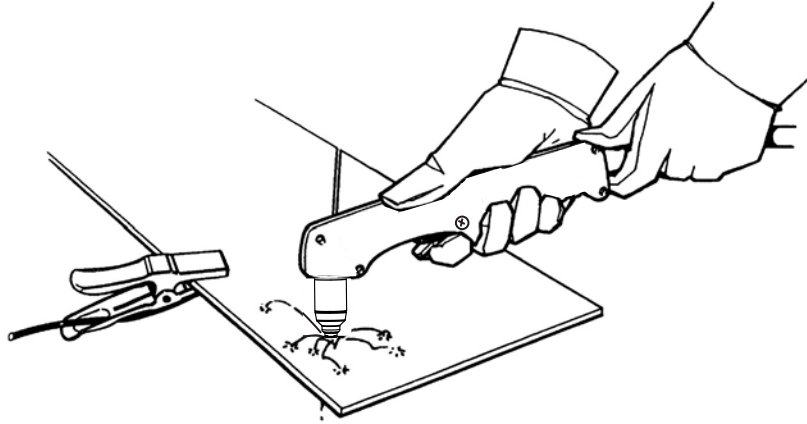

### Power ON the system

Set the ON/OFF switch to the ON (I) position.

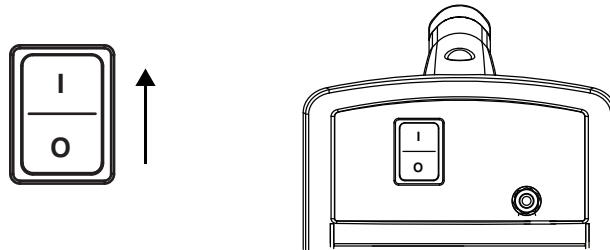

### Adjust the gas pressure and output current

The power ON LED and the gas pressure LED illuminate when there is insufficient gas pressure to the system. Use a high-pressure regulator that is capable of delivering gas to the filter on the power supply at 99.1 L/min at 4.7 bar (3.5 scfm at 68 psi). For more information on attaching the gas supply, see *Prepare the gas supply* on page 27.

1. For cutting, set the regulator between 5.5 and 6.9 bar (80 and 100 psi).
2. Turn the amperage knob to the desired output current based on the input voltage, circuit size, and consumables.

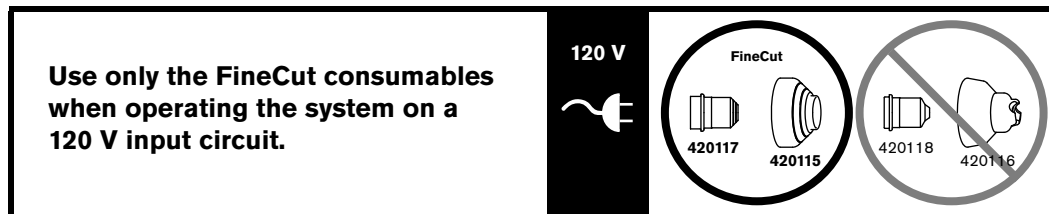

### Operating the system on a 120 V, 15 A circuit

- Set the amperage below 20 A, as indicated by the gray shading around the knob (the inner ring).
- Use only the FineCut nozzle (420117) and deflector (420115).
- Do not use the general-purpose (standard) nozzle (420118) or shield (420116).
- Do not use the HyAccess consumables.
- Verify that nothing else is drawing power from the circuit.

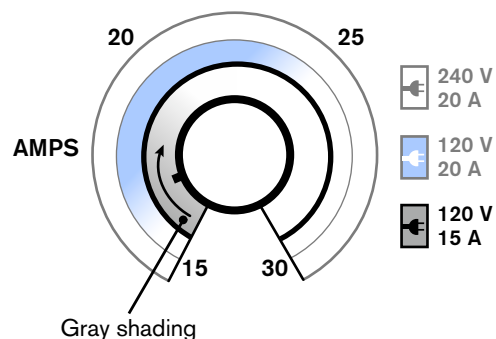

### Operating the system on a 120 V, 20 A circuit

- Set the amperage below 25 A, as indicated by the blue shading around the knob (the middle ring).
- Use only the FineCut nozzle (420117) and deflector (420115).
- Do not use the general-purpose (standard) nozzle (420118) or shield (420116).
- Verify that nothing else is drawing power from the circuit.

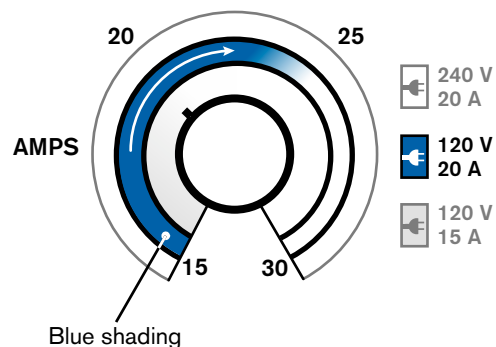

### Operating the system on a 240 V, 20 A circuit

- Set the amperage between 15 – 30 A.
- Use either the general-purpose (standard) or the FineCut consumables.

 Do not mix the general-purpose and FineCut consumables. Use one set or the other.

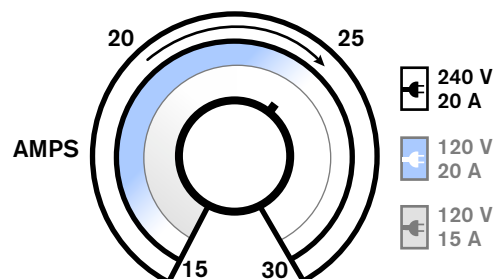

See *Voltage configurations* on page 23 for more information.

### Check the indicator LEDs

Verify that the green power ON LED on the front of the power supply is illuminated and that none of the other LEDs are illuminated or blinking.

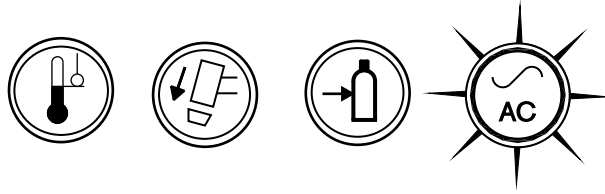

If the temperature, torch cap sensor, or gas pressure LEDs illuminate or blink, or if the power ON LED blinks, correct the fault condition before continuing. See *Basic troubleshooting* on page 58 for more information.

### Verify the system is ready

When the power ON LED illuminates, none of the other LEDs illuminate or blink, and the amperage knob is set, the system is ready for use.

### Understand duty-cycle limitations

The duty cycle is the percentage of time out of 10 minutes that a plasma arc can remain on when operating at an ambient temperature of 40° C (104° F).

With input power of 120 V:

- At 30 A, the arc can remain on for 2.0 minutes out of 10 minutes without causing the unit to overheat (20% duty cycle).
- At 17 A, the arc can remain on for 6 minutes out of 10 (60%).
- At 15 A, the arc can remain on for 10 minutes out of 10 (100%).

With input power of 240 V:

- At 30 A, the arc can remain on for 3.5 minutes out of 10 (35% duty cycle).
- At 23 A, the arc can remain on for 6 minutes out of 10 (60%).
- At 18 A, the arc can remain on for 10 minutes out of 10 (100%).

When the duty cycle is exceeded, the system overheats, the temperature LED illuminates, the arc shuts off, and the cooling fan continues to run. To resume cutting, wait for the temperature LED to extinguish.





The fan may run during normal operation of the system.

---

## System operation guidelines

- To achieve the highest level of performance:
  - Operate the system at an input power of 240 VAC whenever possible.
  - Avoid using an extension cord whenever possible.
-  If you must use an extension cord, use a heavy conductor cord of the shortest possible length. See *Extension cord recommendations* on page 26.
- If you are operating your system on a 120 V, 15 A circuit, do not set the amperage higher than 20 A. See *Voltage configurations* on page 23.
- For best results when operating your system on a 120 V, 15 A circuit:
  - Do not connect anything else that will draw power from the same circuit.
  - Be aware that extension cords can reduce the voltage to the machine from what is output by the circuit. This reduction in power can impair cutting performance and increase the probability of tripping the circuit breaker.
- Cutting a thicker workpiece with the general-purpose (standard) consumables requires a higher amperage setting. It is preferable to operate on a higher rated circuit (240 V / 30 A) when cutting thicker metal. See *Voltage configurations* on page 23.
- Additional techniques to reduce the frequency of tripped circuit breakers include:
  - Turn down the amperage adjustment knob.
  - Avoid stretching the arc. Instead, drag the torch on the workpiece as explained in *Edge start on a workpiece* on page 50.

## Hand torch operation

		<p><b>WARNING!</b> <b>INSTANT-ON TORCHES</b> <b>PLASMA ARC CAN CAUSE INJURY AND BURNS</b></p>
<p>Plasma arc ignites immediately when you press the torch trigger. The plasma arc cuts quickly through gloves and skin.</p> <p>Keep hands, clothes, and objects away from the torch tip.</p> <p>Do not hold the workpiece, and keep your hands clear of the cutting path.</p> <p>Never point the torch toward yourself or others.</p>		

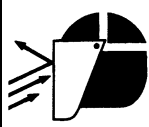
		<p><b>WARNING!</b> <b>SPARKS AND HOT METAL</b> <b>CAN INJURE EYES AND BURN SKIN</b></p>
<p>Always wear proper protective equipment including gloves and eye protection, and point the torch away from yourself and others. Sparks and hot molten metal spray out from the nozzle.</p>		

## Safety catch operation

The hand torch is equipped with a safety catch to prevent accidental firings. When you are ready to cut with the torch, flip the safety catch forward (toward the torch head) and press the red torch trigger.

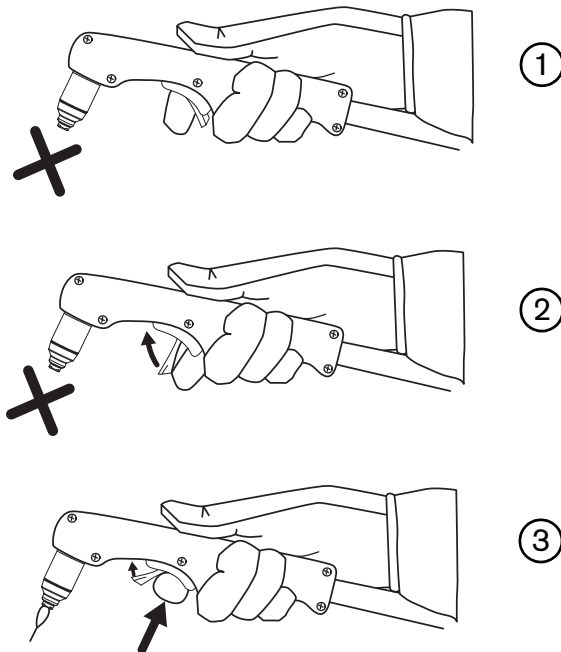



## Hand torch cutting guidelines

- With any set of consumables, drag the torch tip lightly on the workpiece to maintain a steady cut speed.



Sometimes the torch sticks slightly to the workpiece when you cut with the FineCut consumables.

- While cutting, make sure that sparks exit from the bottom of the workpiece. The sparks should lag slightly behind the torch as you cut ( $15^{\circ}$  –  $30^{\circ}$  angle from vertical).
- If sparks spray up, you are not cutting all the way through the workpiece. Move the torch more slowly, or, if possible, increase the output current.
- Hold the torch nozzle perpendicular to the workpiece so that the nozzle is at a  $90^{\circ}$  angle to the cutting surface, and watch the arc as it cuts along the line.

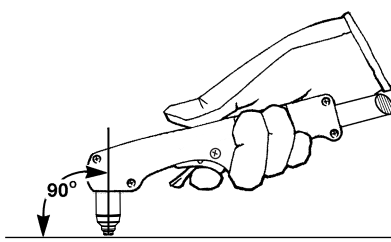

- Pulling the torch toward you along the cut is easier than pushing it or moving from side-to-side.
- For straight-line cuts, use a straight edge as a guide. To cut circles, use a template or a radius cutter attachment (a circle cutting guide). See *Accessory parts* on page 72 for the Hypertherm plasma cutting guide part numbers for cutting circles and making bevel cuts.
- If you fire the torch unnecessarily, you shorten the life of the nozzle and electrode.



## Recommendations for cutting at 120 V

- Use only the FineCut consumables.
  - If you cut at 120 V with the HyAccess consumables, operate the system on a 120 V / 20 A circuit. Cutting with the HyAccess consumables while operating on a 120 V / 15 A circuit is not recommended.
- Do not use an extension cord.
- Verify nothing else is drawing power from the circuit.
- Turn down the current adjustment knob to avoid tripping the breaker.

### Edge start on a workpiece

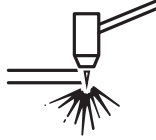

When cutting material thicker than 6 mm (1/4 inch), start the torch at the edge of the workpiece to prolong consumable life.

1. With the ground clamp attached to the workpiece, hold the torch perpendicular (90°) to the workpiece and on the edge.

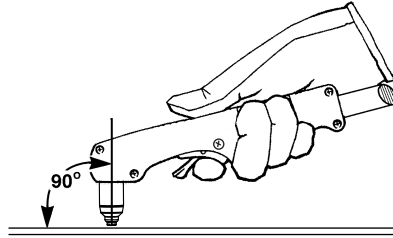

2. Press the torch trigger to start the arc. You may need to pause at the edge until the arc has cut completely through the workpiece.

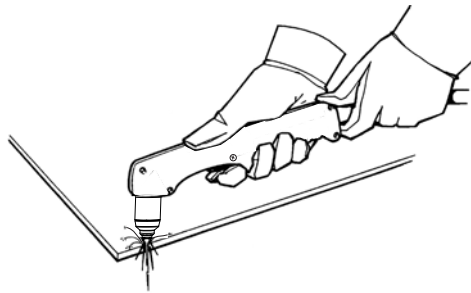

3. Drag the torch lightly across the workpiece to proceed with the cut. Maintain a steady, even pace.

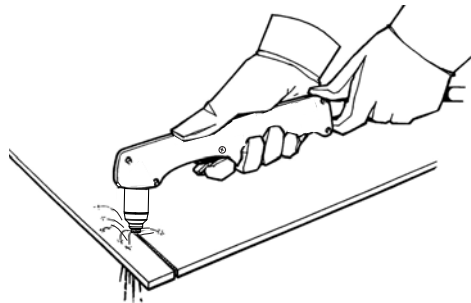

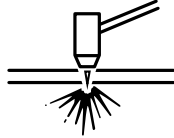
**Pierce a workpiece**

If the metal is thinner than 6 mm (1/4 inch), use piercing to cut an interior feature. Piercing shortens the life of the consumables.

The type of pierce to perform depends on the thickness of the metal.

- **Straight pierce** – For cutting metal that is thinner than 3 mm (1/8 inch).
- **Rolling pierce** – For cutting metal that is 3 mm (1/8 inch) or thicker.

1. Attach the ground clamp to the workpiece.

2. **Straight pierce:** Hold the torch perpendicular (90°) to the workpiece.

**Rolling pierce:** Hold the torch at an approximate 30° angle to the workpiece with the torch tip within 1.5 mm (1/16 inch) of it before firing the torch.

3. **Straight pierce:** Press the torch trigger to start the arc.

**Rolling pierce:** Press the torch trigger to start the arc while still at an angle to the workpiece, then rotate the torch to the perpendicular (90°) position.

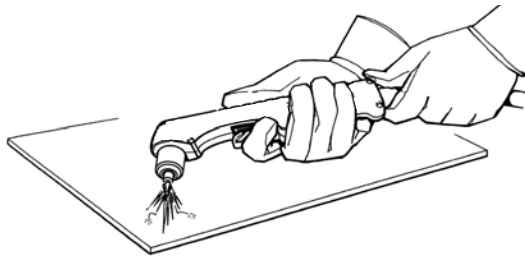

4. Hold the torch in place while continuing to press the trigger. When sparks exit from the bottom of the workpiece, the arc has pierced the metal.

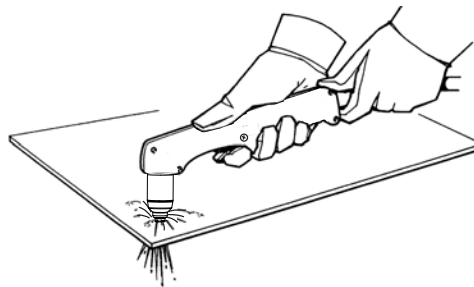

## 4 – Operation

---

5. When the pierce is complete, drag the torch lightly along the workpiece to proceed with the cut.

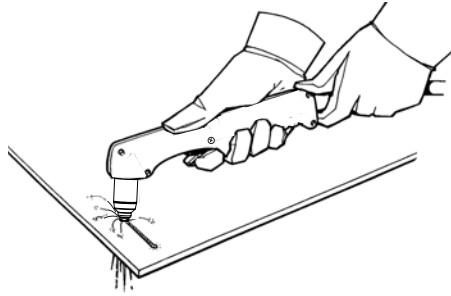

### Gouge a workpiece



You can use this system with the general-purpose (standard) consumables for light gouging applications, such as the removal of spot welds and tack welds.

 The system does not require a dedicated set of consumables or a special mode setting for gouging. However, do not use the FineCut consumables for gouging applications.

1. Hold the torch so that the torch tip is slightly above the workpiece before firing the torch.
2. Hold the torch at a 45° angle to the workpiece with a small gap between the torch tip and the workpiece. Press the trigger to obtain a pilot arc. Transfer the arc to the workpiece.

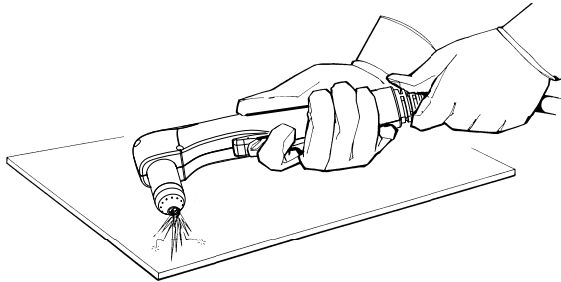

3. Maintain an approximate 45° angle to the workpiece as you feed into the gouge.

Push the plasma arc in the direction of the gouge you want to create. Keep a small distance between the torch tip and the molten metal to avoid reducing consumable life or damaging the torch.

You can vary the gouge profile by varying the:

- ❑ Speed of the torch over the workpiece
- ❑ Torch-to-work standoff distance
- ❑ Angle of the torch to the workpiece

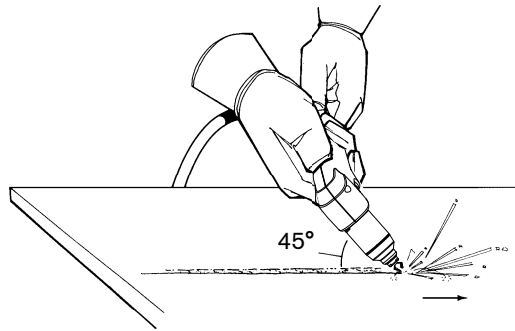

### Varying the gouge profile

Follow these recommendations to change the gouge profile as needed:

- **Increasing the speed** of the torch will **decrease width** and **decrease depth**.
- **Decreasing the speed** of the torch will **increase width** and **increase depth**.
- **Increasing the standoff** of the torch will **increase width** and **decrease depth**.
- **Decreasing the standoff** of the torch will **decrease width** and **increase depth**.
- **Increasing the angle** of the torch (more vertical) will **decrease width** and **increase depth**.
- **Decreasing the angle** of the torch (less vertical) will **increase width** and **decrease depth**.

### Common hand-cutting faults

For more information on faults, see *Basic troubleshooting* on page 58.

- The torch sputters and hisses, but does not produce an arc. The cause can be:
  - Overtightened consumables
- The torch does not cut completely through the workpiece. The causes can be:
  - Cut speed is too fast
  - Worn consumables
  - Metal being cut is too thick for the selected amperage
  - Installation of the wrong consumables
  - Poor electrical contact between the ground clamp and the workpiece
  - Low gas pressure or low gas flow rate
- Cut quality is poor. The causes can be:
  - Metal being cut is too thick for the selected amperage
  - Installation of the wrong consumables
  - Cut speed is too fast or too slow
  - Worn or damaged consumables
- The arc sputters and consumables life is shorter than expected. The causes can be:
  - Moisture in the gas supply
  - Low gas pressure
  - Incorrect installation of the consumables
  - Installation of the wrong consumables

### Minimizing dross

Dross is the molten metal that solidifies on the workpiece. Some amount of dross is always present when cutting with air plasma. However, you can control the amount and type of dross by adjusting your system correctly for your application.

Low-speed dross forms when the torch's cutting speed is too slow and the arc shoots ahead. It forms as a heavy, bubbly deposit at the bottom of the cut and is usually easy to remove. Increase your speed to reduce this type of dross.

High-speed dross forms when the cutting speed is too fast and the arc lags behind. It forms as a thin, linear bead of solid metal attached very close to the cut. It forms to the bottom of the cut and is often more difficult to remove. Decrease your speed to reduce this type of dross.





Dross is more likely to form on warm or hot metal than on cool metal. For example, the first cut in a series of cuts is likely to produce the least dross. As the workpiece heats up, more dross may form on subsequent cuts.



Worn or damaged consumables may produce intermittent dross.

Perform routine maintenance

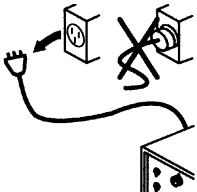
		<p><b>WARNING!</b> <b>ELECTRIC SHOCK CAN KILL</b></p>
		<p>Disconnect electrical power before performing any maintenance that involves removing the cover from the power supply or the consumables from the torch.</p> <p>All work requiring removal of the power supply cover must be performed by a qualified technician.</p> <p>See the <i>Safety and Compliance Manual (80669C)</i> for more safety precautions.</p>

## 5 – Maintenance and Troubleshooting

### Every use:

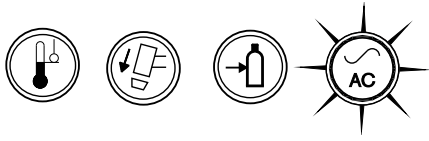

Check the indicator lights and correct any fault conditions.

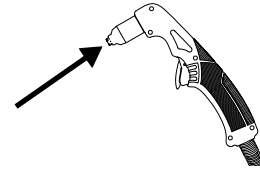

Inspect the consumables for proper installation and wear.

### Every 3 months:



Replace any damaged labels.

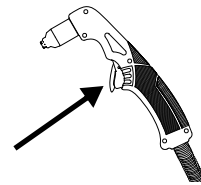

Inspect the trigger for damage. Inspect the torch body for cracks and exposed wires. Replace any damaged parts.

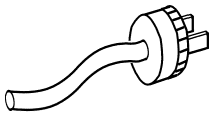

Inspect the power cord and plug. Replace if damaged.

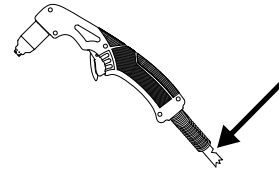

Inspect the torch lead. Replace if damaged.

### Every 6 months:

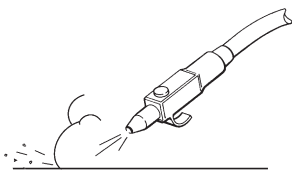



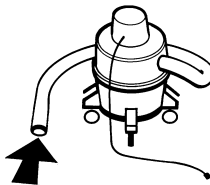



or



Clean the inside of the power supply with moisture-free compressed air or a vacuum.

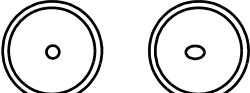

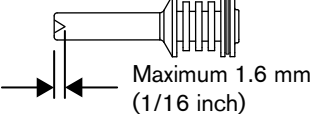
**Inspect the consumables**

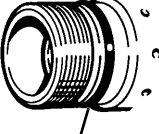

Part	Inspect	Action
 <p>Shield      Deflector</p>	<p>The center hole for roundness.</p> <p>The gap between the nozzle and the shield or deflector for accumulated debris.</p>	<p>Replace the shield or deflector if the hole is no longer round.</p> <p>Remove the shield or deflector and clean any material away.</p>
 <p>Nozzle</p>	<p>The center hole for roundness.</p>  <p>Good      Worn</p>	<p>Replace if the center hole is not round. Replace the nozzle and the electrode together.</p>
 <p>Electrode</p>	<p>The center surface for wear and verify the pit depth.</p>  <p>Maximum 1.6 mm (1/16 inch)</p>	<p>Replace if the surface is severely worn or the pit depth is greater than 1.6 mm (1/16 inch) deep. Replace the nozzle and the electrode together.</p>
 <p>Swirl ring</p>	<p>The internal surface for damage or wear and the gas holes for blockages.</p> <p>Whether the electrode can still slide freely through the swirl ring.</p>	<p>Replace if the surface is damaged or worn or any of the gas holes are blocked.</p> <p>If the electrode cannot slide freely through the swirl ring, replace the swirl ring.</p>
 <p>Torch O-ring</p>	<p>The surface for damage, wear, or a lack of lubrication.</p>	<p>If the O-ring is dry, apply a thin film of silicone lubricant on the O-ring and the threads. The O-ring should look shiny, but there should not be any excess or built-up lubricant.</p> <p>If the O-ring is cracked or worn, replace it (428179).</p>

### Basic troubleshooting

The following table provides an overview of the most common problems that may arise when using this system and explains how to solve them.

If you are unable to fix the problem by following this basic troubleshooting guide or if you need further assistance:

1. Call your distributor or authorized repair facility.
2. Call the nearest office listed in the front of this manual.

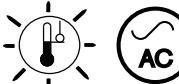

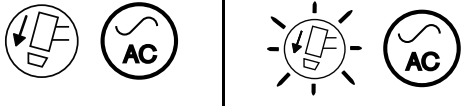
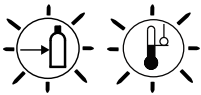
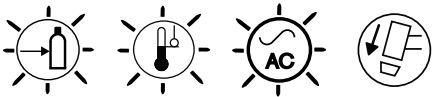
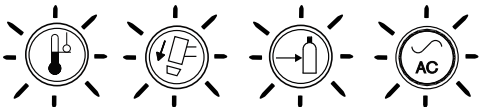
Problem	Solution
<p>The ON/OFF power switch is set to ON (I), but the power ON LED does not illuminate.</p>	<ul style="list-style-type: none"> <li>▪ Verify that the power cord is plugged into the receptacle.</li> <li>▪ Verify that the power is on at the main power panel or at the disconnect-power switch box.</li> <li>▪ Verify that the line voltage is not too low (more than 15% below the rated voltage).</li> </ul>
<p>The power ON LED and the gas pressure LED illuminate.</p> 	<ul style="list-style-type: none"> <li>▪ Verify that the gas supply line is connected to the power supply and the gas is turned on.</li> <li>▪ Inspect the gas supply line for leaks, and verify the incoming gas pressure.</li> </ul>
<p>The power ON LED and the temperature LED illuminate.</p> 	<ul style="list-style-type: none"> <li>▪ Leave the system on to allow the fan to cool the power supply.</li> <li>▪ If the system's internal temperature approaches -30° C (-22° F), the temperature LED may illuminate. Move the system to a warmer location.</li> </ul>
<p>The power ON LED illuminates and the temperature LED blinks.</p> 	<p>Leave the system on to allow the fan to cool the power supply. The temperature LED blinks when the system continuously draws too much input current for too long. Try the following to prevent this condition:</p> <ul style="list-style-type: none"> <li>▪ Turn down the cutting current. See <i>Adjust the gas pressure and output current</i> on page 44.</li> <li>▪ Use only the FineCut consumables when operating the system on a 120 VAC input circuit. See <i>Choose the consumables</i> on page 30.</li> <li>▪ Operate the system on a 240 VAC input circuit whenever possible.</li> <li>▪ Avoid stretching the arc. Drag the torch on the workpiece. See <i>Edge start on a workpiece</i> on page 50.</li> <li>▪ Operate the system without using an extension cord. If you must use an extension cord, use a heavy conductor cord of the shortest possible length. See <i>Extension cord recommendations</i> on page 26.</li> <li>▪ Verify nothing else is drawing power on the same circuit.</li> </ul>

Problem	Solution
<p>The power ON LED blinks.</p> 	<ul style="list-style-type: none"> <li>Have an electrical technician check the incoming power. The input line voltage is either too high or too low (a variance greater than <math>\pm 15\%</math> of the rated voltage). See <i>Hypertherm system ratings</i> on page 17 and <i>Prepare the electrical power</i> on page 23.</li> </ul>
<p>The power ON LED illuminates and the torch cap LED illuminates or blinks.</p> 	<ul style="list-style-type: none"> <li>Turn OFF the power supply. Verify that the consumables are properly installed and tightened. See <i>Install the consumables</i> on page 42.</li> <li>If the consumables became loose or were removed while the power supply was ON, turn OFF the power supply, correct the problem, and then turn ON the power supply to clear the fault.</li> <li>If the consumables appear to be installed correctly, the torch may be damaged. Contact your distributor or authorized repair facility.</li> </ul>
<p>The gas pressure and temperature LEDs blink when the machine is powered ON.</p> 	<ul style="list-style-type: none"> <li>Release the trigger and restart the power supply. The system automatically disables itself when the power supply is turned on while the torch trigger is pressed.</li> </ul>
<p>The temperature, gas pressure, and power ON LEDs blink, and the torch cap LED illuminates.</p> 	<ul style="list-style-type: none"> <li>Install new consumables in the torch (they may be corroded or approaching end of life).</li> <li>If you continue to see this error, contact your distributor or authorized repair facility.</li> </ul>
<p>All four LEDs blink when the system is powered ON.</p> 	<ul style="list-style-type: none"> <li>A qualified service technician must service the system. Contact your distributor or use the information in the front of this manual to contact technical service.</li> </ul>
<p>The arc does not transfer to the workpiece.</p>	<ul style="list-style-type: none"> <li>Clean the area where the ground clamp contacts the workpiece to ensure a good metal-to-metal contact.</li> <li>Inspect the ground clamp for damage and repair it if necessary.</li> <li>Move the torch closer to the workpiece and fire the torch again. See <i>Hand torch operation</i> on page 48.</li> </ul>
<p>The torch does not cut completely through the workpiece.</p>	<ul style="list-style-type: none"> <li>Verify that the torch is being used correctly. See <i>Hand torch operation</i> on page 48.</li> <li>Inspect the consumables and replace as necessary. See <i>Inspect the consumables</i> on page 57.</li> </ul>

## 5 – Maintenance and Troubleshooting

Problem	Solution
<p>The arc blows out but re-ignites when the torch trigger is pressed again.</p>	<ul style="list-style-type: none"> <li>▪ Inspect and replace the consumable parts if they are worn or damaged. See <i>Inspect the consumables</i> on page 57.</li> <li>▪ Replace the air filter element if it is contaminated. See <i>Replace the air filter element and air filter bowl</i> on page 61.</li> <li>▪ Make sure the air pressure is at the proper level.</li> </ul>
<p>The arc sputters and hisses.</p>	<ul style="list-style-type: none"> <li>▪ Replace the air filter element. See <i>Replace the air filter element and air filter bowl</i> on page 61.</li> <li>▪ Inspect the gas line for moisture. If necessary, install or replace the gas filtration to the power supply. See <i>Prepare the gas supply</i> on page 27.</li> </ul>
<p>The cut quality is poor.</p>	<ul style="list-style-type: none"> <li>▪ Verify that the torch is being used correctly. See <i>Hand torch operation</i> on page 48.</li> <li>▪ Verify the correct consumables are installed. See <i>Choose the consumables</i> on page 30.</li> <li>▪ Inspect the consumables and replace as necessary. See <i>Inspect the consumables</i> on page 57.</li> <li>▪ Loosen the consumables about 1/8th of a turn and try again.</li> <li>▪ Check the air pressure and air quality.</li> <li>▪ Verify the work lead connection is secure and there is no damage to the work lead.</li> <li>▪ Operate the system without using an extension cord. If you must use an extension cord, use a heavy conductor cord of the shortest possible length. See <i>Extension cord recommendations</i> on page 26.</li> </ul>
<p>The circuit breaker trips while you are cutting.</p>	<ul style="list-style-type: none"> <li>▪ Turn down the cutting current. See <i>Adjust the gas pressure and output current</i> on page 44.</li> <li>▪ Use only the FineCut consumables when operating the system on a 120 VAC input circuit. See <i>Choose the consumables</i> on page 30.</li> <li>▪ Operate the system on a 240 VAC input circuit whenever possible.</li> <li>▪ Avoid stretching the arc. Drag the torch on the workpiece. See <i>Edge start on a workpiece</i> on page 50.</li> <li>▪ Operate the system without using an extension cord. If you must use an extension cord, use a heavy conductor cord of the shortest possible length. See <i>Extension cord recommendations</i> on page 26.</li> <li>▪ Verify nothing else is drawing power on the same circuit.</li> </ul>

## Maintenance procedures

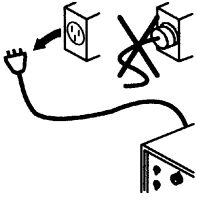
		<p><b>WARNING!</b> <b>ELECTRIC SHOCK CAN KILL</b></p>
		<p><b>Disconnect electrical power before performing any maintenance that involves removing the cover from the power supply or the consumables from the torch.</b></p> <p><b>All work requiring removal of the power supply cover must be performed by a qualified technician.</b></p> <p><b>See the <i>Safety and Compliance Manual (80669C)</i> for more safety precautions.</b></p>

### Replace the air filter element and air filter bowl

The following procedure explains how to remove the air filter element and air filter bowl inside the power supply and replace them with new ones.

 You can also use this procedure to replace the plastic retaining nut on the air filter/regulator assembly. Refer to *Air filter/regulator with pressure switch assembly (interior, fan side)* on page 68 for the Hypertherm kit numbers needed to order these replacement parts.

#### Remove the power supply cover and handle

1. Set the power switch to OFF (O). Disconnect the power cord, and disconnect the gas supply.
2. Remove the two screws from the handle on the top of the power supply. Gently pull on the panel nearest the screw you are removing to keep pressure on the screw. When the screw is almost out, tilt the screwdriver slightly to help pull the screw out of the recessed hole.
3. Slightly tip the front and rear panels away from the power supply so that you can get the edges of the handle out from underneath them. Remove the handle, and set it and the two screws aside.
4. Continue to tilt the panels outward to release the sides of the cover from their tracks. Then lift the cover off the power supply.

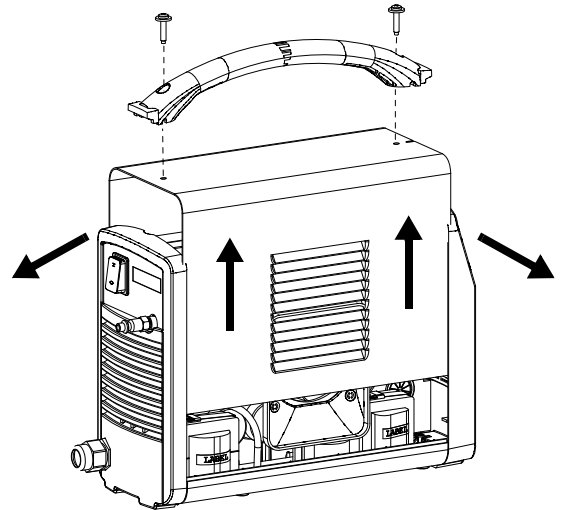

## 5 – Maintenance and Troubleshooting

### Remove the old air filter element and air filter bowl

1. From the fan side of the power supply, disconnect the drain hose ① from the hole in the bottom of the base.
2. Remove the other end of the drain hose from the brass fitting ② at the bottom of the air filter bowl. Set the drain hose aside.
3. Unscrew the plastic retainer nut ③ that holds the air filter/regulator ④ in the bracket ⑤ on the center panel.
4. Tilt the bottom of the air filter/regulator assembly towards you with one hand.
5. With your other hand, unscrew the air filter bowl ⑥ to remove it from the air filter/regulator assembly.

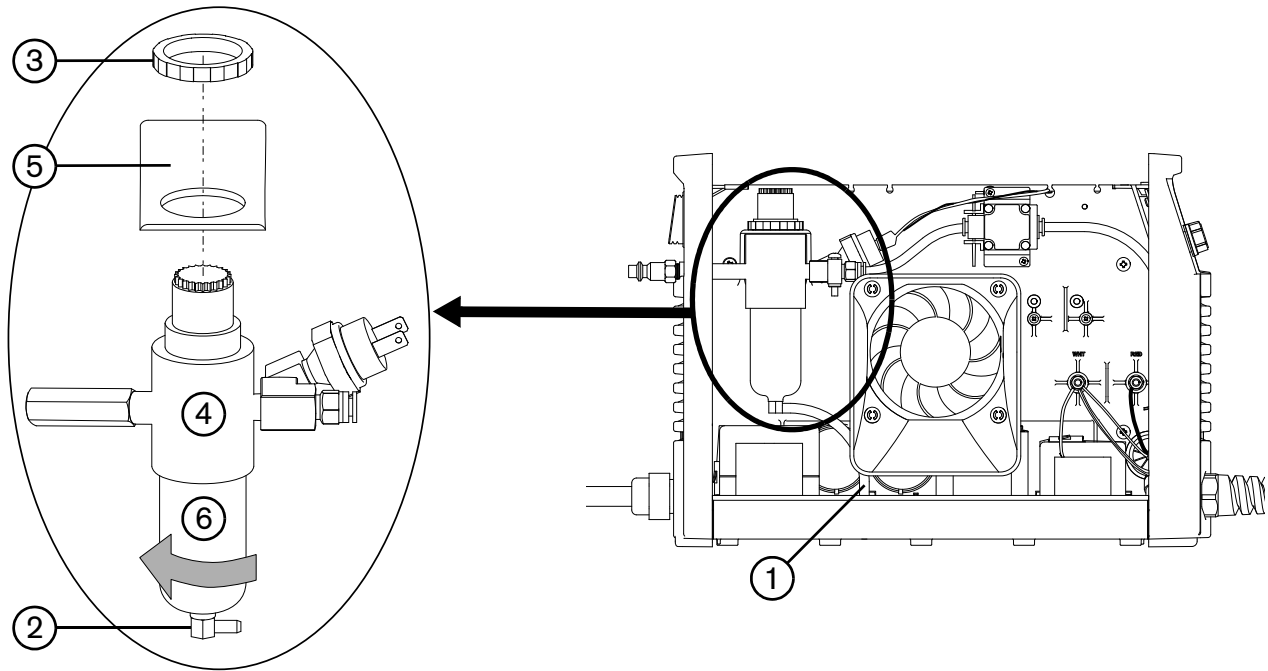

### 6. Does the air filter element ⑦ need to be replaced?

- ❑ If yes, unscrew the plastic retaining nut ⑧ that secures the air filter element, being careful not to lose the spring ⑨ that is compressed between the retaining nut and the air filter/regulator. Do not allow the air filter element to rotate as you remove the nut. Remove the air filter element from the plastic retaining nut.
- ❑ If no, continue with Step 3 on page 63.

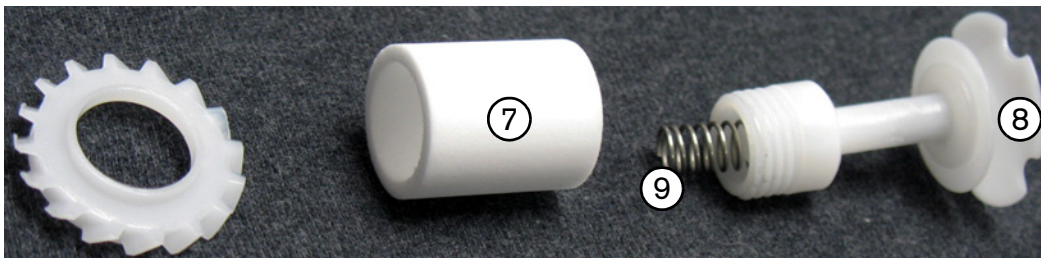

### Install the new air filter element and air filter bowl

1. Place the new air filter element ① on the plastic retaining nut. Verify that the spring is in place.
2. Install the new air filter element. Tighten the retaining nut ② to finger-tight.
3. Does the air filter bowl ③ need to be replaced?
  - ❑ If yes, install the new filter bowl.
  - ❑ If no, clean the bowl before reinstalling it by wiping away any oil, dirt, or other contaminants.
 Tighten the filter bowl to finger-tight.
4. Connect the drain hose ④ to the fitting ⑤ at the bottom of the filter bowl. Verify the drain hose extends towards the front of the power supply.
5. Position the air filter/regulator assembly in the bracket on the center panel of the power supply, and secure it using the plastic retainer nut ⑥. Hand-tighten the retainer nut plus a quarter turn.



Do not overtighten the retainer nut.

6. Route the drain hose through the hole in the base of the power supply.
7. Reconnect the gas supply, and check for leaks at each fitting and hose connection point on the air filter/regulator assembly.

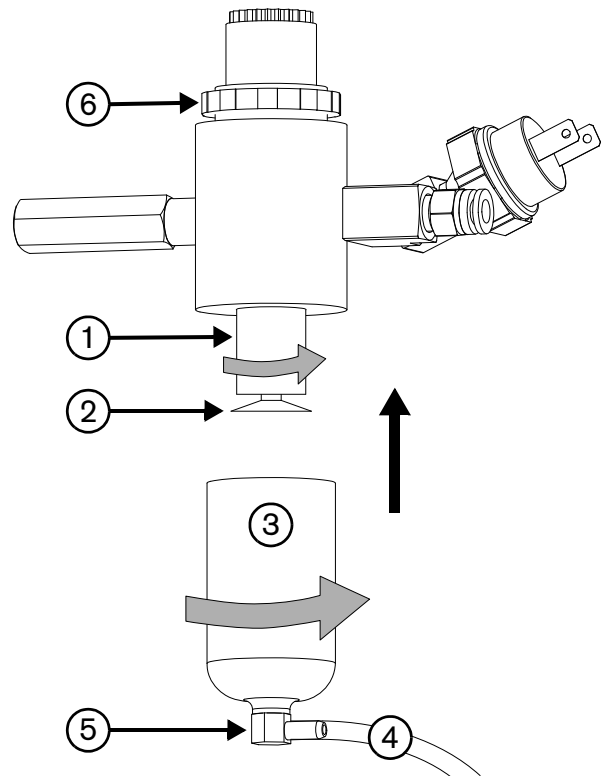

### CAUTION!

Gas supply pressures not within the specifications in the *Specifications* section of this manual can cause poor cut quality, poor consumable life, and operational problems.

If the purity level of the gas is too low, or if there are leaks in the supply hoses or connections:

- Cut speeds can decrease.
- Cut quality can deteriorate.
- Cutting thickness capability can decrease.
- Parts life can shorten.

## 5 – Maintenance and Troubleshooting

---

### Put the power supply cover and handle back in place

1. Being careful not to pinch any wires, slide the cover onto the power supply. Align the bottom edges with the tracks, and align the slot in the top of the cover ① with the tab ② on the front panel ③ so that the louvers in the cover are in front of the fan.
2. Realign the front panel with the power supply.
3. Realign the rear panel with the power supply, making sure that the hole in the ground clip is aligned with the screw holes in both the panel and the power supply.
4. Position the handle over the holes in the top of the cover, and position the ends of the handle underneath the edges of the panels.
5. Reinstall the two screws that secure the cover and handle with a torque setting of 23.0 kg-cm (20 inch-pounds).
6. Reconnect the electrical power, and turn ON the power supply.

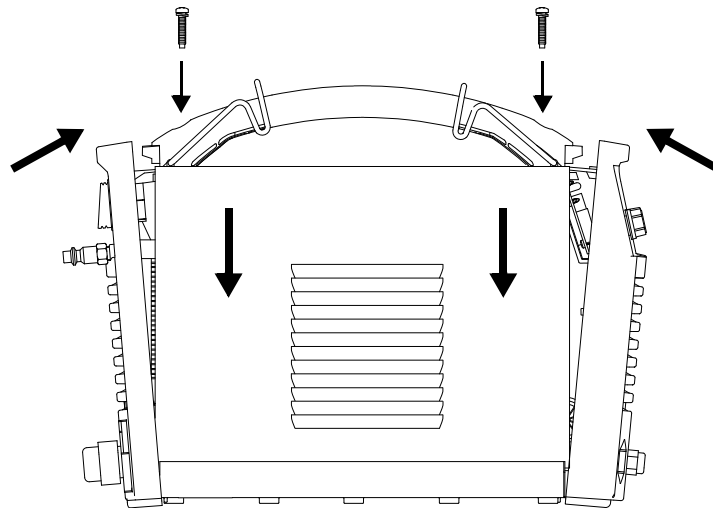
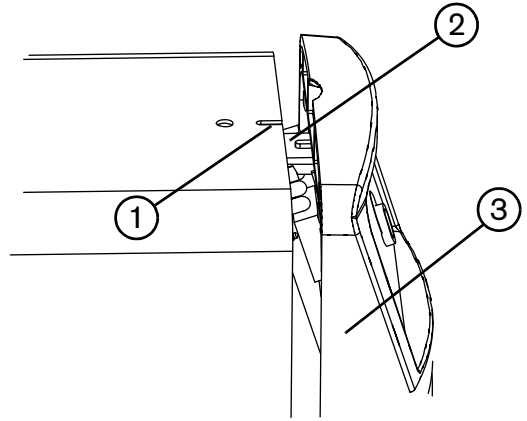



## Section 6

### Parts

---

Use the Hypertherm kit and part numbers in this section to order replacement parts, consumables, and accessories for your Powermax30 XP power supply and Duramax LT hand torch.

For instructions on installing the air filter element and the air filter bowl in the power supply, refer to *Maintenance procedures* on page 61.

For instructions on installing the consumables in the Duramax LT hand torch, see *Install the consumables* on page 42.

## Power supply parts

### Exterior, front

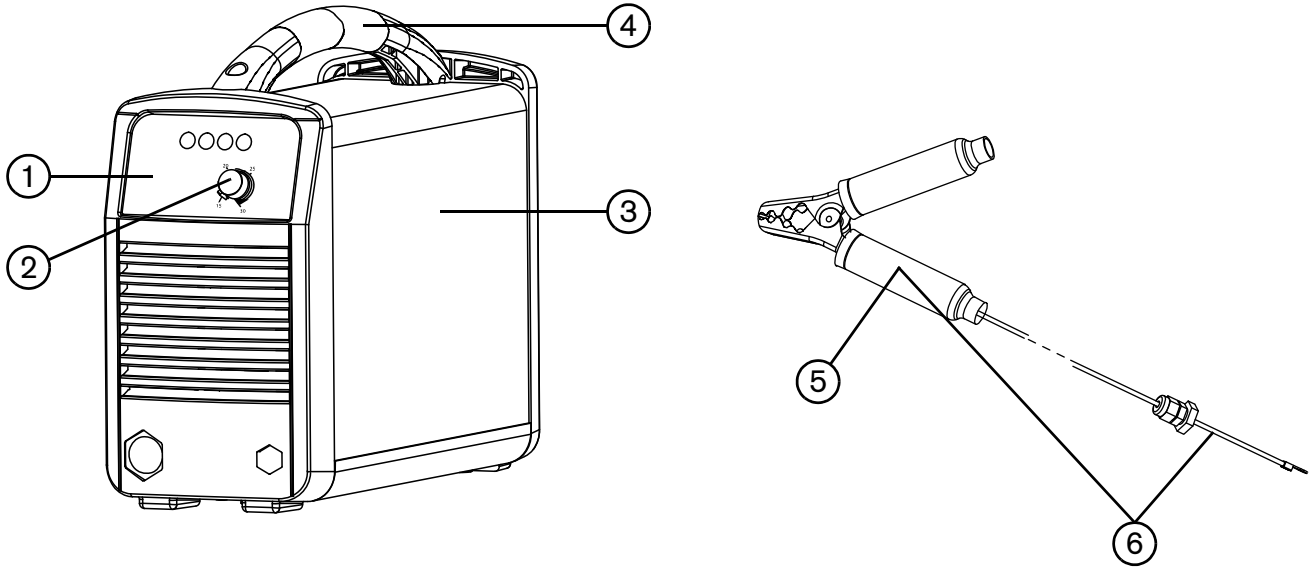

Item	Kit number	Description
	228096	Kit: Screws for the power supply cover and handle (not shown)
1	428219	Kit: Front panel
2	428226	Kit: Current adjustment knob
3	428221	Kit: Power supply cover with labels, CSA
3	428222	Kit: Power supply cover with labels, CSA, Built in America
3	428224	Kit: Power supply cover with labels, CE
3	428225	Kit: Power supply cover with labels, CCC
4	228099	Kit: Handle with screws
5	228561	Kit: Ground clamp
6	428239	Kit: Work lead, 4.6 m (15 feet), with ground clamp

## Exterior, rear

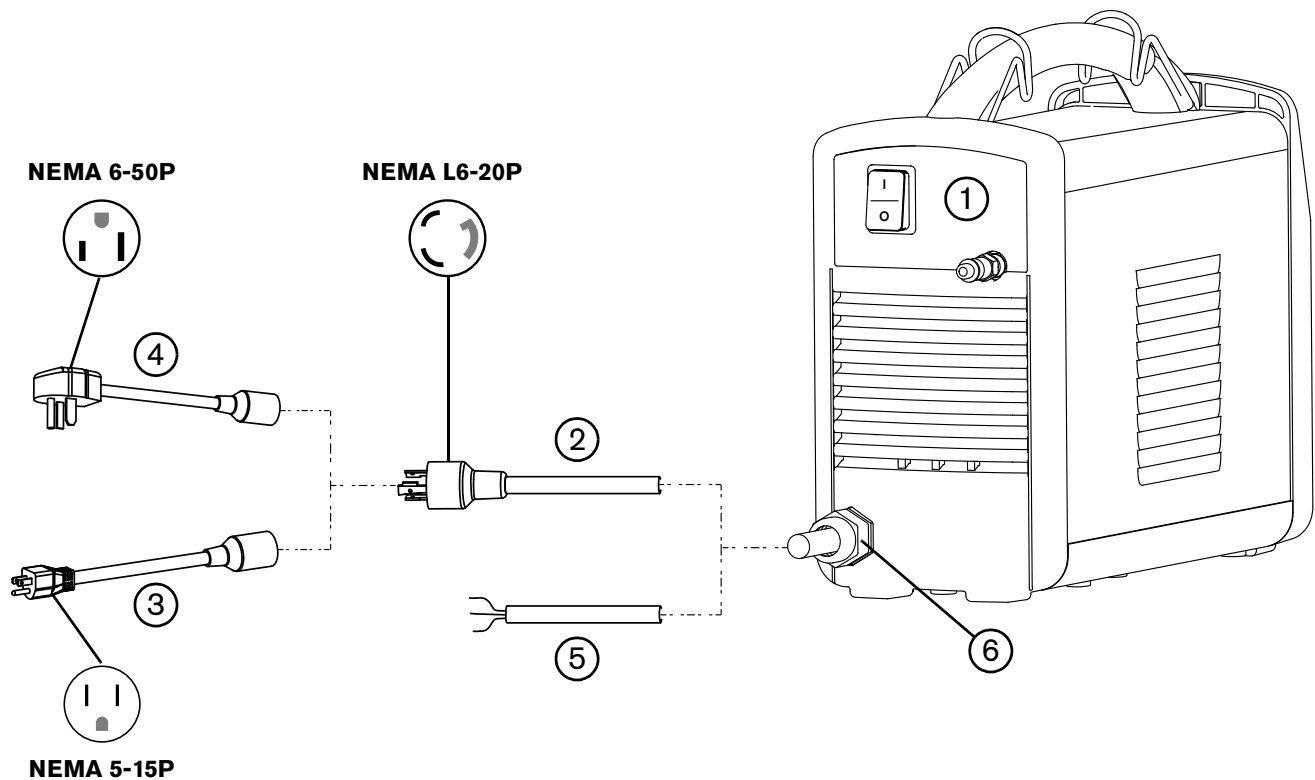

Item	Kit number	Description
1	428220	Kit: Rear panel
2	228210	Kit: CSA power cord with NEMA twist lock-style 240 V / 20 A plug, 1-phase, 3.0 m (10 feet)
3	229132	CSA power cord extension: 120 V / 15 A plug adapter
4	229133	CSA power cord extension: 240 V / 20 A plug adapter
5	228140	Kit: CE power cord, 1-phase, 3.0 m (10 feet) (plug not included)
5	428231	Kit: CCC power cord, 1-phase, 3.0 m (10 feet) (plug not included)
6	228143	Kit: Power cord strain relief

**Air filter/regulator with pressure switch assembly (interior, fan side)**

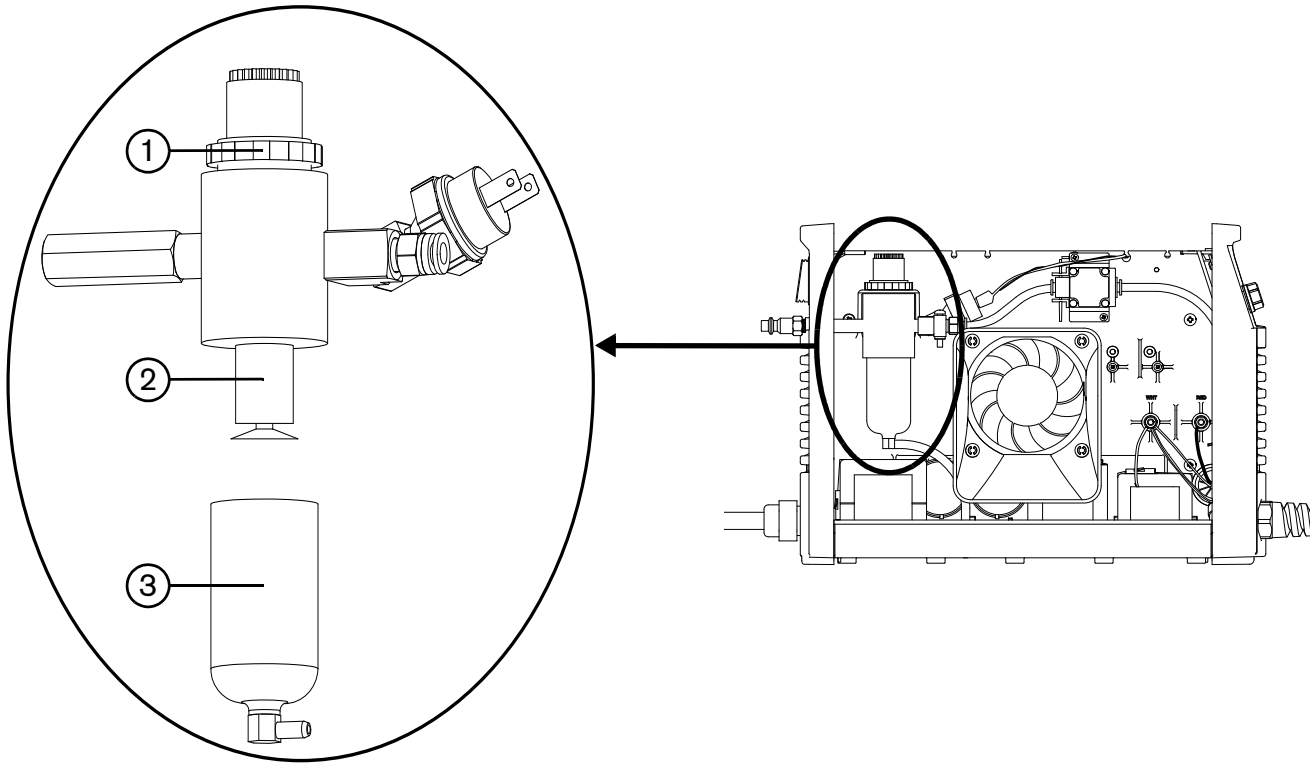

<b>Item</b>	<b>Kit number</b>	<b>Description</b>
1	428262	Kit: Air filter retaining nut
2	428237	Kit: Air filter element
3	428246	Kit: Air filter bowl (with O-ring)

## Duramax LT hand torch parts

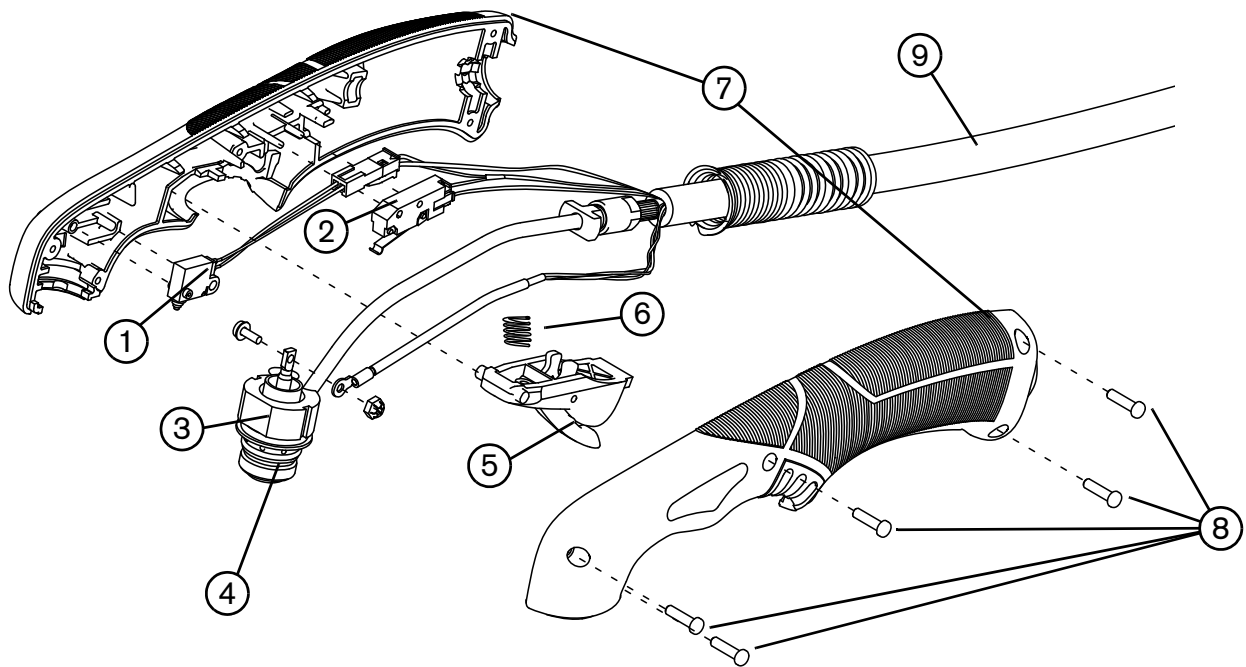

You can replace the entire hand torch and lead assembly, or you can replace individual torch components.

Item	Kit number	Description
	428174*	Kit: Duramax LT hand torch assembly with 4.6 m (15 foot) lead
1	228109	Kit: Torch cap-sensor switch
2	428162	Kit: Torch start switch
3	428178	Kit: Duramax LT torch body (includes O-ring)
4	428179	Kit: Replacement O-rings for torch body
5	428156	Kit: Torch trigger and spring
6	428182	Kit: Replacement springs for torch trigger
7	428177	Kit: Duramax LT torch handle (includes handle screws)
8	428181	Kit: Duramax LT torch replacement handle screws
9	428176	Kit: Duramax LT torch lead, 4.6 m (15 feet), with strain relief

\* The torch assembly includes one set of general-purpose (standard) consumables:

- Electrode (420120)
- Swirl ring (420211)
- Retaining cap (420114)
- Nozzle (420118)
- Shield (420116)

### Duramax LT hand torch consumables

To order consumables for your Duramax LT torch, use the following part numbers.

You can order packs of nozzles or electrodes, or you can order them combined as a kit:

- Use **420120** to order a pack of electrodes
- Use **420118** to order a pack of general-purpose (standard) nozzles
- Use **420117** to order a pack of FineCut nozzles
- Use **428243** to order a kit of 2 general-purpose (standard) nozzles with 2 electrodes
- Use **428244** to order a kit of 2 FineCut nozzles with 2 electrodes

Replace the nozzle and electrode at the same time.



Use the same electrode, swirl ring, and retaining cap for both general-purpose (standard) and FineCut applications. Do not use the general-purpose nozzle with the deflector; do not use the FineCut nozzle with the shield.

### General-purpose (standard) consumables

420211

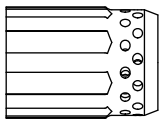

Swirl ring

420120

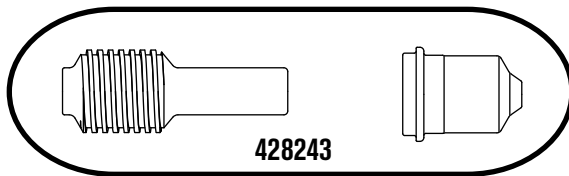

Electrode

420118

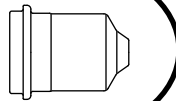

Nozzle

420114

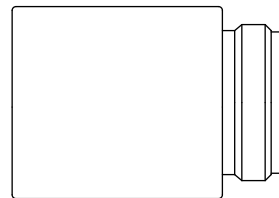

Retaining cap

420116

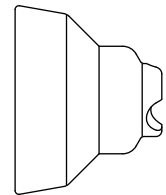

Shield

### FineCut consumables

420211

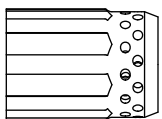

Swirl ring

420120

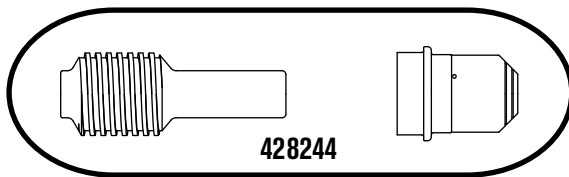

Electrode

420117

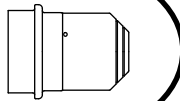

Nozzle

420114

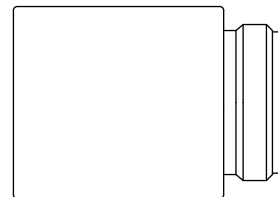

Retaining cap

420115

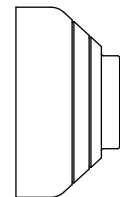

Deflector

## HyAccess consumables

HyAccess consumables do not ship with the system. You can order each one separately or in a starter kit. They extend the reach of the general-purpose (standard) consumables by approximately 7.5 cm (3 inches).

Two HyAccess nozzles are available:

- **420144** – Standard nozzle designed for a broad range of cutting applications
- **420147** – Gouging nozzle designed specifically for gouging

When the tip of the nozzle wears out, replace the entire nozzle.

 Replace the nozzle and electrode at the same time.

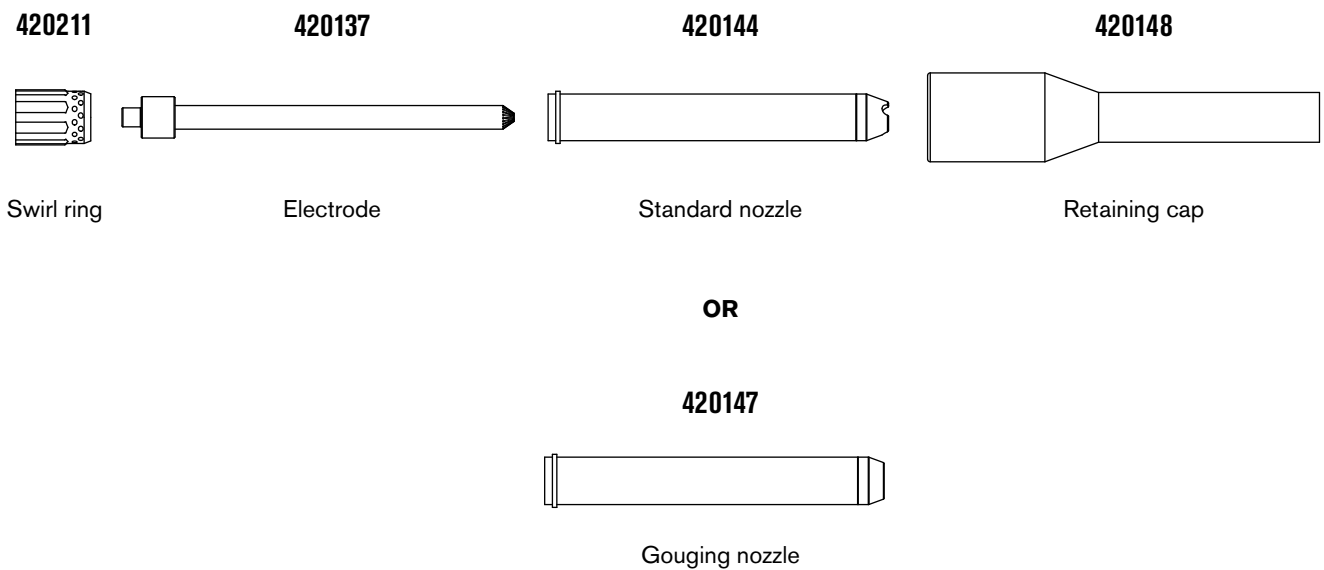

The **428337** starter kit contains:

- 2 HyAccess electrodes
- 1 HyAccess cutting nozzle
- 1 HyAccess gouging nozzle
- 1 swirl ring
- 1 HyAccess retaining cap

 The standard Powermax30 XP swirl ring is compatible with the HyAccess consumables.

### Accessory parts

<b>Part number</b>	<b>Description</b>
127102	Basic plasma (circle) cutting guide
027668	Deluxe plasma (circle) cutting guide
127144	Dust cover
127410	Carrying case
428337	Kit: HyAccess consumables starter kit
024548	Leather torch lead cover, brown, 7.6 m (25 feet)
024877	Leather torch lead cover, black with Hypertherm logo, 7.6 m (25 feet)
127217	Shoulder strap
128647	Kit: Elimizer air filtration
127169	Leather cutting gloves
127416	Protective glasses, shade 5 lens
127103	Face shield, shade 8 lens
127239	Face shield, shade 6 lens
127105	Replacement lens for face shield, shade 8
127243	Replacement lens for face shield, shade 6
128836	Thermal grease, 1/8 ounce
027055	Silicone lubricant, 1/4 ounce



# Powermax30 XP labels

Kit number	Description
428215	Kit: Powermax30 XP labels, CSA
428216	Kit: Powermax30 XP labels, CSA, Built in America
428217	Kit: Powermax30 XP labels, CE
428218	Kit: Powermax30 XP labels, CCC

The label kits include:

- Consumables label
- Appropriate safety labels
- Front and side decals

The following illustrations show the consumables label and safety labels.

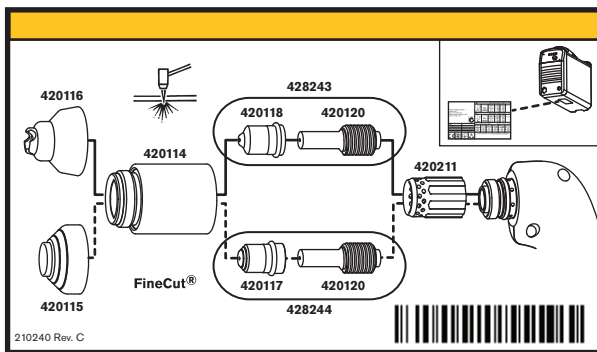

Consumables label



CE/CCC safety label

	Read and follow these instructions, employer safety practices, and material safety data sheets. Refer to ANS Z49.1, "Safety in Welding, Cutting and Allied Processes" from American Welding Society ( <a href="http://www.aws.org">http://www.aws.org</a> ) and OSHA Safety and Health Standards, 29 CFR 1910 ( <a href="http://www.osha.gov">http://www.osha.gov</a> ).	<b>WARNING</b>	<b>AVERTISSEMENT</b>
		<b>1. Cutting sparks can cause explosion or fire.</b> 1.1 Do not cut near flammables. 1.2 Have a fire extinguisher nearby and ready to use. 1.3 Do not use a drum or other closed container as a cutting table.	<b>1. Les étincelles de coupage peuvent provoquer une explosion ou un incendie.</b> 1.1 Ne pas couper près des matières inflammables. 1.2 Un extincteur doit être à proximité et prêt à être utilisé. 1.3 Ne pas utiliser un fût ou un autre contenant fermé comme table de coupage.
		<b>2. Plasma arc can injure and burn; point the nozzle away from yourself. Arc starts instantly when triggered.</b> 2.1 Turn off power before disassembling torch. 2.2 Do not grip the workpiece near the cutting path. 2.3 Wear complete body protection.	<b>2. L'arc plasma peut blesser et brûler; éloigner la buse de soi. Il s'allume instantanément quand on l'amorce;</b> 2.1 Couper l'alimentation avant de démonter la torche. 2.2 Ne pas saisir la pièce à couper de la trajectoire de coupage. 2.3 Se protéger entièrement le corps.
		<b>3. Hazardous voltage. Risk of electric shock or burn.</b> 3.1 Wear insulating gloves. Replace gloves when wet or damaged. 3.2 Protect from shock by insulating yourself from work and ground. 3.3 Disconnect power before servicing. Do not touch live parts.	<b>3. Tension dangereuse. Risque de choc électrique ou de brûlure.</b> 3.1 Porter des gants isolants. Remplacer les gants quand ils sont humidifiés ou endommagés. 3.2 Se protéger contre les chocs en s'isolant de la pièce et de la terre. 3.3 Couper l'alimentation avant l'entretien. Ne pas toucher les pièces sous tension.
		<b>4. Plasma fumes can be hazardous.</b> 4.1 Do not inhale fumes. 4.2 Use forced ventilation or local exhaust to remove the fumes. 4.3 Do not operate in closed spaces. Remove fumes with ventilation.	<b>4. Les fumées plasma peuvent être dangereuses.</b> 4.1 Ne pas inhaler les fumées. 4.2 Utiliser une ventilation forcée ou un extracteur local pour dissiper les fumées. 4.3 Ne pas couper dans des espaces clos. Chasser les fumées par ventilation.
		<b>5. Arc rays can burn eyes and injure skin.</b> 5.1 Wear correct and appropriate protective equipment to protect head, eyes, ears, hands, and body. Button shirt collar. Protect ears from noise. Use welding helmet with the correct shade of filter.	<b>5. Les rayons d'arc peuvent brûler les yeux et blesser la peau.</b> 5.1 Porter un bon équipement de protection pour se protéger la tête, les yeux, les oreilles, les mains et le corps. Boutonner le col de la chemise. Protéger les oreilles contre le bruit. Utiliser un masque de soudeur avec un filtre de nuance appropriée.
		<b>6. Become trained. Only qualified personnel should operate this equipment. Use torches specified in the manual. Keep non-qualified personnel and children away.</b> <b>7. Do not remove, destroy, or cover this label.</b> Replace if it is missing, damaged, or worn (PN 110584 Rev D).	<b>6. Suivre une formation. Seul le personnel qualifié a le droit de faire fonctionner cet équipement. Utiliser exclusivement les torches indiquées dans le manuel. Le personnel non qualifié et les enfants doivent se tenir à l'écart.</b> <b>7. Ne pas enlever, détruire ni couvrir cette étiquette.</b> La remplacer si elle est absente, endommagée ou usée (PN 110584 Rev D).

CSA safety label

