



OM-229 930A

2009-01

Processes



MIG (GMAW) Welding
Flux Cored (FCAW)



Stick (SMAW) Welding



TIG (GTAW) Welding



Air Plasma Cutting and Gouging
with Spectrum[®] Unit



Air Carbon Arc (CAC-A) Cutting
and Gouging

Description



Engine Driven Welding Generator And
Air Compressor

Trailblazer[®] 302 Air Pak[™]

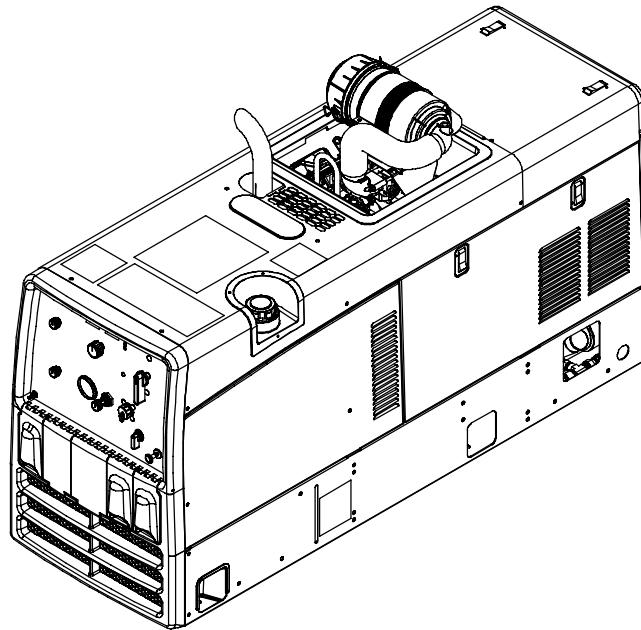

Visit our website at
www.MillerWelds.com

OWNER'S MANUAL

File: Engine Drive



From Miller to You

Thank you and congratulations on choosing Miller. Now you can get the job done and get it done right. We know you don't have time to do it any other way.

That's why when Niels Miller first started building arc welders in 1929, he made sure his products offered long-lasting value and superior quality. Like you, his customers couldn't afford anything less. Miller products had to be more than the best they could be. They had to be the best you could buy.

Today, the people that build and sell Miller products continue the tradition. They're just as committed to providing equipment and service that meets the high standards of quality and value established in 1929.

This Owner's Manual is designed to help you get the most out of your Miller products. Please take time to read the Safety precautions. They will help you protect yourself against potential hazards on the worksite.

We've made installation and operation quick and easy. With Miller you can count on years of reliable service with proper maintenance. And if for some reason the unit needs repair, there's a Troubleshooting section that will help you figure out what the problem is. The parts list will then help you to decide the exact part you may need to fix the problem. Warranty and service information for your particular model are also provided.



Miller is the first welding equipment manufacturer in the U.S.A. to be registered to the ISO 9001:2000 Quality System Standard.

Miller Electric manufactures a full line of welders and welding related equipment. For information on other quality Miller products, contact your local Miller distributor to receive the latest full line catalog or individual specification sheets. **To locate your nearest distributor or service agency call 1-800-4-A-Miller, or visit us at www.MillerWelds.com on the web.**



Working as hard as you do – every power source from Miller is backed by the most hassle-free warranty in the business.



TABLE OF CONTENTS

SECTION 1 – SAFETY PRECAUTIONS – READ BEFORE USING	1
1-1. Symbol Usage	1
1-2. Arc Welding Hazards	1
1-3. Engine Hazards	3
1-4. Hydraulic Hazards	3
1-5. Compressed Air Hazards	4
1-6. Additional Symbols For Installation, Operation, And Maintenance	5
1-7. California Proposition 65 Warnings	6
1-8. Principal Safety Standards	6
1-9. EMF Information	6
SECTION 2 – CONSIGNES DE SÉCURITÉ – LIRE AVANT UTILISATION	7
2-1. Signification des symboles	7
2-2. Dangers relatifs au soudage à l'arc	7
2-3. Dangers existant en relation avec le moteur	9
2-4. Dangers liés à l'hydraulique	10
2-5. Dangers liés à l'air comprimé	11
2-6. Dangers supplémentaires en relation avec l'installation, le fonctionnement et la maintenance	12
2-7. Proposition californienne 65 Avertissements	13
2-8. Principales normes de sécurité	13
2-9. Information EMF	14
SECTION 3 – DEFINITIONS	15
3-1. Symbol Definitions	15
SECTION 4 – SPECIFICATIONS	16
4-1. Weld, Power, And Engine Specifications	16
4-2. Air Compressor Specifications	16
4-3. Sound Level Table – 4 Meter (13.1 Ft) Reading Per SAE J2101	16
4-4. Dimensions, Weights, and Operating Angles	17
4-5. Fuel Consumption Curves	18
4-6. Generator Power Curve	19
4-7. Duty Cycle	19
4-8. Stick And MIG Mode Volt-Ampere Curves	20
4-9. TIG Mode Volt-Ampere Curves	21
SECTION 5 – INSTALLATION	22
5-1. Serial Number And Rating Label Location	22
5-2. Installing Welding Generator	22
5-3. Grounding Generator To Truck Or Trailer Frame	23
5-4. Engine Prestart Checks	24
5-5. Compressor Prestart Checks	25
5-6. Connecting the Battery	26
5-7. Installing Exhaust Pipe	26
5-8. Weld Output Terminals	27
5-9. Connecting To Weld Output Terminals	27
5-10. Selecting Weld Cable Sizes*	28
5-11. Remote Receptacle Information	28
5-12. Connecting To The Air Compressor	29
SECTION 6 – OPERATING WELDING GENERATOR	30
6-1. Engine Controls	30
6-2. Cold Weather Engine Operation	30
6-3. Voltage/Amperage Control	31
6-4. Process/Contactor Switch	32
6-5. Stick Scratch Start	33
6-6. Lift-Arct TIG With Auto-Crater And Auto-Stop	34
6-7. Remote Voltage/Amperage Control	35

TABLE OF CONTENTS

SECTION 7 – COMPRESSOR OPERATION	36
7-1. Air Compressor Switch	36
7-2. Air Compressor Gauge And Regulator	37
7-3. Air Compressor Overload Protection	37
7-4. Compressor Blow Down	38
SECTION 8 – OPERATING AUXILIARY EQUIPMENT	39
8-1. Generator Power Receptacles And Supplementary Protectors	39
8-2. Optional GFCI Receptacles	39
8-3. Simultaneous Weld And Power	40
8-4. Wiring Instructions For Optional 240 Volt, Single-Phase Plug (NEMA 14-50P)	40
SECTION 9 – GENERATOR/ENGINE MAINTENANCE	41
9-1. Maintenance Label	41
9-2. Routine Generator/Engine Maintenance	42
9-3. Servicing Air Cleaner	43
9-4. Changing Engine Oil, Oil Filter, And Fuel Filter	44
9-5. Overload Protection	45
9-6. Servicing Optional Spark Arrestor	46
SECTION 10 – AIR COMPRESSOR MAINTENANCE	47
10-1. Maintenance	47
10-2. Compressor Maintenance Label	48
10-3. Servicing Compressor Air Cleaner And Air/Oil Separator	49
10-4. Changing Air Compressor Oil And Filter	50
SECTION 11 – TROUBLESHOOTING	51
11-1. Front Panel Display Code Information	51
11-2. Welding Troubleshooting	52
11-3. Generator Power Troubleshooting	53
11-4. Engine Troubleshooting	53
11-5. Compressor Troubleshooting	54
SECTION 12 – PARTS LIST	56
12-1. Recommended Spare Parts	56
SECTION 13 – ELECTRICAL DIAGRAMS	58
SECTION 14 – GENERATOR POWER GUIDELINES	60
OPTIONS AND ACCESSORIES	
WARRANTY	

SECTION 1 – SAFETY PRECAUTIONS – READ BEFORE USING

rom_2008-08

 Protect yourself and others from injury — read and follow these precautions.

1-1. Symbol Usage



DANGER! – Indicates a hazardous situation which, if not avoided, will result in death or serious injury. The possible hazards are shown in the adjoining symbols or explained in the text.



Indicates a hazardous situation which, if not avoided, could result in death or serious injury. The possible hazards are shown in the adjoining symbols or explained in the text.

NOTICE – Indicates statements not related to personal injury.

 Indicates special instructions.



This group of symbols means Warning! Watch Out! ELECTRIC SHOCK, MOVING PARTS, and HOT PARTS hazards. Consult symbols and related instructions below for necessary actions to avoid the hazards.

1-2. Arc Welding Hazards



The symbols shown below are used throughout this manual to call attention to and identify possible hazards. When you see the symbol, watch out, and follow the related instructions to avoid the hazard. The safety information given below is only a summary of the more complete safety information found in the Safety Standards listed in Section 1-8. Read and follow all Safety Standards.



Only qualified persons should install, operate, maintain, and repair this unit.



During operation, keep everybody, especially children, away.



ELECTRIC SHOCK can kill.

Touching live electrical parts can cause fatal shocks or severe burns. The electrode and work circuit is electrically live whenever the output is on. The input power circuit and machine internal circuits are also live when power is on. In semiautomatic or automatic wire welding, the wire, wire reel, drive roll housing, and all metal parts touching the welding wire are electrically live. Incorrectly installed or improperly grounded equipment is a hazard.

- Do not touch live electrical parts.
- Wear dry, hole-free insulating gloves and body protection.
- Insulate yourself from work and ground using dry insulating mats or covers big enough to prevent any physical contact with the work or ground.
- Do not use AC output in damp areas, if movement is confined, or if there is a danger of falling.
- Use AC output ONLY if required for the welding process.
- If AC output is required, use remote output control if present on unit.
- Additional safety precautions are required when any of the following electrically hazardous conditions are present: in damp locations or while wearing wet clothing; on metal structures such as floors, gratings, or scaffolds; when in cramped positions such as sitting, kneeling, or lying; or when there is a high risk of unavoidable or accidental contact with the workpiece or ground. For these conditions, use the following equipment in order presented: 1) a semiautomatic DC constant voltage (wire) welder, 2) a DC manual (stick) welder, or 3) an AC welder with reduced open-circuit voltage. In most situations, use of a DC, constant voltage wire welder is recommended. And, do not work alone!
- Disconnect input power or stop engine before installing or servicing this equipment. Lockout/tagout input power according to OSHA 29 CFR 1910.147 (see Safety Standards).
- Properly install and ground this equipment according to its Owner's Manual and national, state, and local codes.

- Always verify the supply ground — check and be sure that input power cord ground wire is properly connected to ground terminal in disconnect box or that cord plug is connected to a properly grounded receptacle outlet.
- When making input connections, attach proper grounding conductor first – double-check connections.
- Keep cords dry, free of oil and grease, and protected from hot metal and sparks.
- Frequently inspect input power cord for damage or bare wiring — replace cord immediately if damaged — bare wiring can kill.
- Turn off all equipment when not in use.
- Do not use worn, damaged, undersized, or poorly spliced cables.
- Do not drape cables over your body.
- If earth grounding of the workpiece is required, ground it directly with a separate cable.
- Do not touch electrode if you are in contact with the work, ground, or another electrode from a different machine.
- Use only well-maintained equipment. Repair or replace damaged parts at once. Maintain unit according to manual.
- Do not touch electrode holders connected to two welding machines at the same time since double open-circuit voltage will be present.
- Wear a safety harness if working above floor level.
- Keep all panels and covers securely in place.
- Clamp work cable with good metal-to-metal contact to workpiece or worktable as near the weld as practical.
- Insulate work clamp when not connected to workpiece to prevent contact with any metal object.
- Do not connect more than one electrode or work cable to any single weld output terminal.

SIGNIFICANT DC VOLTAGE exists in inverters after stopping engine.

- Stop engine on inverter and discharge input capacitors according to instructions in Maintenance Section before touching any parts.



HOT PARTS can cause severe burns.

- Do not touch hot parts bare handed.
- Allow cooling period before working on equipment.
- To handle hot parts, use proper tools and/or wear heavy, insulated welding gloves and clothing to prevent burns.

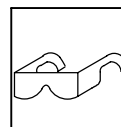

FLYING METAL or DIRT can injure eyes.

- Welding, chipping, wire brushing, and grinding cause sparks and flying metal. As welds cool, they can throw off slag.
- Wear approved safety glasses with side shields even under your welding helmet.



FUMES AND GASES can be hazardous.

Welding produces fumes and gases. Breathing these fumes and gases can be hazardous to your health.

- Keep your head out of the fumes. Do not breathe the fumes.
- If inside, ventilate the area and/or use local forced ventilation at the arc to remove welding fumes and gases.
- If ventilation is poor, wear an approved air-supplied respirator.
- Read and understand the Material Safety Data Sheets (MSDSs) and the manufacturer's instructions for metals, consumables, coatings, cleaners, and degreasers.
- Work in a confined space only if it is well ventilated, or while wearing an air-supplied respirator. Always have a trained watch-person nearby. Welding fumes and gases can displace air and lower the oxygen level causing injury or death. Be sure the breathing air is safe.
- Do not weld in locations near degreasing, cleaning, or spraying operations. The heat and rays of the arc can react with vapors to form highly toxic and irritating gases.
- Do not weld on coated metals, such as galvanized, lead, or cadmium plated steel, unless the coating is removed from the weld area, the area is well ventilated, and while wearing an air-supplied respirator. The coatings and any metals containing these elements can give off toxic fumes if welded.



BUILDUP OF GAS can injure or kill.

- Shut off shielding gas supply when not in use.
- Always ventilate confined spaces or use approved air-supplied respirator.



ARC RAYS can burn eyes and skin.

Arc rays from the welding process produce intense visible and invisible (ultraviolet and infrared) rays that can burn eyes and skin. Sparks fly off from the weld.

- Wear an approved welding helmet fitted with a proper shade of filter lenses to protect your face and eyes from arc rays and sparks when welding or watching (see ANSI Z49.1 and Z87.1 listed in Safety Standards).
- Wear approved safety glasses with side shields under your helmet.
- Use protective screens or barriers to protect others from flash, glare, and sparks; warn others not to watch the arc.
- Wear protective clothing made from durable, flame-resistant material (leather, heavy cotton, or wool) and foot protection.



WELDING can cause fire or explosion.

Welding on closed containers, such as tanks, drums, or pipes, can cause them to blow up. Sparks can fly off from the welding arc. The flying sparks, hot workpiece, and hot equipment can cause fires and burns. Accidental contact of electrode to metal objects can cause sparks, explosion, overheating, or fire. Check and be sure the area is safe before doing any welding.

- Remove all flammables within 35 ft (10.7 m) of the welding arc. If this is not possible, tightly cover them with approved covers.
- Do not weld where flying sparks can strike flammable material.
- Protect yourself and others from flying sparks and hot metal.
- Be alert that welding sparks and hot materials from welding can easily go through small cracks and openings to adjacent areas.
- Watch for fire, and keep a fire extinguisher nearby.
- Be aware that welding on a ceiling, floor, bulkhead, or partition can cause fire on the hidden side.

- Do not weld on closed containers such as tanks, drums, or pipes, unless they are properly prepared according to AWS F4.1 (see Safety Standards).
- Do not weld where the atmosphere may contain flammable dust, gas, or liquid vapors (such as gasoline).
- Connect work cable to the work as close to the welding area as practical to prevent welding current from traveling long, possibly unknown paths and causing electric shock, sparks, and fire hazards.
- Do not use welder to thaw frozen pipes.
- Remove stick electrode from holder or cut off welding wire at contact tip when not in use.
- Wear oil-free protective garments such as leather gloves, heavy shirt, cuffless trousers, high shoes, and a cap.
- Remove any combustibles, such as a butane lighter or matches, from your person before doing any welding.
- After completion of work, inspect area to ensure it is free of sparks, glowing embers, and flames.
- Use only correct fuses or circuit breakers. Do not oversize or bypass them.
- Follow requirements in OSHA 1910.252 (a) (2) (iv) and NFPA 51B for hot work and have a fire watcher and extinguisher nearby.



NOISE can damage hearing.

Noise from some processes or equipment can damage hearing.

- Wear approved ear protection if noise level is high.



MAGNETIC FIELDS can affect Implanted Medical Devices.

- Wearers of Pacemakers and other Implanted Medical Devices should keep away.
- Implanted Medical Device wearers should consult their doctor and the device manufacturer before going near arc welding, spot welding, gouging, plasma arc cutting, or induction heating operations.

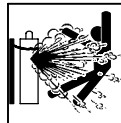

CYLINDERS can explode if damaged.

Shielding gas cylinders contain gas under high pressure. If damaged, a cylinder can explode. Since gas cylinders are normally part of the welding process, be sure to treat them carefully.

- Protect compressed gas cylinders from excessive heat, mechanical shocks, physical damage, slag, open flames, sparks, and arcs.
- Install cylinders in an upright position by securing to a stationary support or cylinder rack to prevent falling or tipping.
- Keep cylinders away from any welding or other electrical circuits.
- Never drape a welding torch over a gas cylinder.
- Never allow a welding electrode to touch any cylinder.
- Never weld on a pressurized cylinder — explosion will result.
- Use only correct shielding gas cylinders, regulators, hoses, and fittings designed for the specific application; maintain them and associated parts in good condition.
- Turn face away from valve outlet when opening cylinder valve.
- Keep protective cap in place over valve except when cylinder is in use or connected for use.
- Use the right equipment, correct procedures, and sufficient number of persons to lift and move cylinders.
- Read and follow instructions on compressed gas cylinders, associated equipment, and Compressed Gas Association (CGA) publication P-1 listed in Safety Standards.

1-3. Engine Hazards



BATTERY EXPLOSION can BLIND.

- Always wear a face shield, rubber gloves, and protective clothing when working on a battery.
- Stop engine before disconnecting or connecting battery cables or servicing battery.
- Do not allow tools to cause sparks when working on a battery.
- Do not use welder to charge batteries or jump start vehicles.
- Observe correct polarity (+ and -) on batteries.
- Disconnect negative (-) cable first and connect it last.



FUEL can cause fire or explosion.

- Stop engine and let it cool off before checking or adding fuel.
- Do not add fuel while smoking or if unit is near any sparks or open flames.
- Do not overfill tank — allow room for fuel to expand.
- Do not spill fuel. If fuel is spilled, clean up before starting engine.
- Dispose of rags in a fireproof container.
- Always keep nozzle in contact with tank when fueling.



MOVING PARTS can injure.

- Keep away from fans, belts, and rotors.
- Keep all doors, panels, covers, and guards closed and securely in place.
- Stop engine before installing or connecting unit.
- Have only qualified people remove doors, panels, covers, or guards for maintenance and troubleshooting as necessary.
- To prevent accidental starting during servicing, disconnect negative (-) battery cable from battery.
- Keep hands, hair, loose clothing, and tools away from moving parts.
- Reinstall doors, panels, covers, or guards when servicing is finished and before starting engine.
- Before working on generator, remove spark plugs or injectors to keep engine from kicking back or starting.
- Block flywheel so that it will not turn while working on generator components.



EXHAUST SPARKS can cause fire.

- Do not let engine exhaust sparks cause fire.
- Use approved engine exhaust spark arrestor in required areas — see applicable codes.



HOT PARTS can cause severe burns.

- Do not touch hot parts bare handed.
- Allow cooling period before working on equipment.
- To handle hot parts, use proper tools and/or wear heavy, insulated welding gloves and clothing to prevent burns.

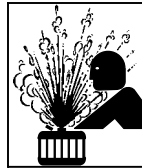

STEAM AND HOT COOLANT can burn.

- If possible, check coolant level when engine is cold to avoid scalding.
- Always check coolant level at overflow tank, if present on unit, instead of radiator (unless told otherwise in maintenance section or engine manual).
- If the engine is warm, checking is needed, and there is no overflow tank, follow the next two statements.
- Wear safety glasses and gloves and put a rag over radiator cap.
- Turn cap slightly and let pressure escape slowly before completely removing cap.

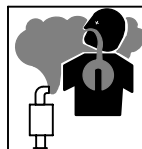

Using a generator indoors CAN KILL YOU IN MINUTES.

- Generator exhaust contains carbon monoxide. This is a poison you cannot see or smell.
- NEVER use inside a home or garage, EVEN IF doors and windows are open.
- Only use OUTSIDE and far away from windows, doors, and vents.

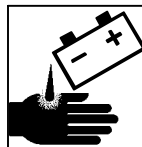

BATTERY ACID can BURN SKIN and EYES.

- Do not tip battery.
- Replace damaged battery.
- Flush eyes and skin immediately with water.



ENGINE HEAT can cause fire.

- Do not locate unit on, over, or near combustible surfaces or flammables.
- Keep exhaust and exhaust pipes way from flammables.

1-4. Hydraulic Hazards

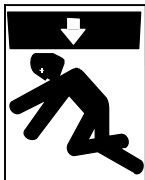

HYDRAULIC EQUIPMENT can injure or kill.

- Incorrect installation or operation of this unit could result in equipment failure and personal injury. Only qualified persons should install, operate, and service this unit according to its Owner's Manual, industry standards, and national, state, and local codes.
- Do not exceed the rated output or capacity of the hydraulic pump or any equipment in the hydraulic system. Design hydraulic system so failure of any hydraulic component will not put people or property at risk.
- Before working on hydraulic system, turn off and lockout/tagout unit, release pressure, and be sure hydraulic pressure cannot be accidentally applied.
- Do not work on hydraulic system with unit running unless you are a qualified person and following the manufacturer's instructions.
- Do not modify or alter hydraulic pump or manufacturer-supplied equipment. Do not disconnect, disable, or override any safety equipment in the hydraulic system.
- Use only components/accessories approved by the manufacturer.
- Keep away from potential pinch points or crush points created by equipment connected to the hydraulic system.
- Do not work under or around any equipment that is supported only by hydraulic pressure. Properly support equipment by mechanical means.



HYDRAULIC FLUID can injure or kill.

- Before working on hydraulic system, turn off and lockout/tagout unit, release pressure, and be sure hydraulic pressure cannot be accidentally applied.
- Relieve pressure before disconnecting or connecting hydraulic lines.
- Check hydraulic system components and all connections and hoses for damage, leaks, and wear before operating unit.
- Wear protective equipment such as safety glasses, leather gloves, heavy shirt and trousers, high shoes, and a cap when working on hydraulic system.

- Use a piece of paper or cardboard to search for leaks—never use bare hands. Do not use equipment if leaks are found.
- HYDRAULIC FLUID is FLAMMABLE—do not work on hydraulics near sparks or flames; do not smoke near hydraulic fluid.
- Reinstall doors, panels, covers, or guards when servicing is finished and before starting unit.
- If ANY fluid is injected into the skin, it must be surgically removed within a few hours by a doctor familiar with this type of injury or gangrene may result.



MOVING PARTS can injure.

- Keep away from fans, belts and rotors.
- Keep all doors, panels, covers, and guards closed and securely in place.

1-5. Compressed Air Hazards

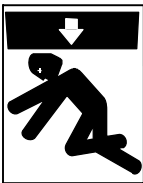

COMPRESSED AIR EQUIPMENT can injure or kill.

- Incorrect installation or operation of this unit could result in equipment failure and personal injury. Only qualified persons should install, operate, and service this unit according to its Owner's Manual, industry standards, and national, state, and local codes.
- Do not exceed the rated output or capacity of the compressor or any equipment in the compressed air system. Design compressed air system so failure of any component will not put people or property at risk.
- Before working on compressed air system, turn off and lockout/tagout unit, release pressure, and be sure air pressure cannot be accidentally applied.
- Do not work on compressed air system with unit running unless you are a qualified person and following the manufacturer's instructions.
- Do not modify or alter compressor or manufacturer-supplied equipment. Do not disconnect, disable, or override any safety equipment in the compressed air system.
- Use only components and accessories approved by the manufacturer.
- Keep away from potential pinch points or crush points created by equipment connected to the compressed air system.
- Do not work under or around any equipment that is supported only by air pressure. Properly support equipment by mechanical means.

- Keep hands, hair, loose clothing, and tools away from moving parts.
- Before working on hydraulic system, turn off and lockout/tagout unit, release pressure, and be sure hydraulic pressure cannot be accidentally applied.
- Have only qualified people remove guards or covers for maintenance and troubleshooting as necessary.
- Reinstall doors, panels, covers, or guards when servicing is finished and before starting engine.



HOT PARTS AND FLUID can cause severe burns.

- Do not touch hot parts bare handed or allow hot fluid to contact skin.
- Allow cooling period before working on equipment.
- To handle hot parts, use proper tools and/or wear heavy, insulated welding gloves and clothing to prevent burns.

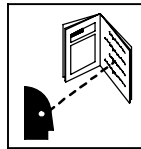

READ INSTRUCTIONS.

- Read Owner's Manual before installing, operating, or servicing unit.
- Use only genuine replacement parts from the manufacturer.
- Perform maintenance and service according to the Owner's Manuals, industry standards, and national, state, and local codes.



COMPRESSED AIR can injure or kill.

- Before working on compressed air system, turn off and lockout/tagout unit, release pressure, and be sure air pressure cannot be accidentally applied.
- Relieve pressure before disconnecting or connecting air lines.
- Check compressed air system components and all connections and hoses for damage, leaks, and wear before operating unit.
- Do not direct air stream toward self or others.
- Wear protective equipment such as safety glasses, hearing protection, leather gloves, heavy shirt and trousers, high shoes, and a cap when working on compressed air system.
- Use soapy water or an ultrasonic detector to search for leaks—never use bare hands. Do not use equipment if leaks are found.
- Reinstall doors, panels, covers, or guards when servicing is finished and before starting unit.
- If ANY air is injected into the skin or body seek medical help immediately.



BREATHING COMPRESSED AIR can injure or kill.

- Do not use compressed air for breathing.
- Use only for cutting, gouging, and tools.



MOVING PARTS can injure.

- Keep away from fans, belts and rotors.
- Keep all doors, panels, covers, and guards closed and securely in place.

- Keep hands, hair, loose clothing, and tools away from moving parts.
- Before working on compressed air system, turn off and lockout/tagout unit, release pressure, and be sure air pressure cannot be accidentally applied.
- Have only qualified people remove guards or covers for maintenance and troubleshooting as necessary.
- Reinstall doors, panels, covers, or guards when servicing is finished and before starting engine.



TRAPPED AIR PRESSURE AND WHIPPING HOSES can injure.

- Release air pressure from tools and system before servicing, adding or changing attachments, or opening compressor oil drain or oil fill cap.



HOT PARTS can cause severe burns.

- Do not touch hot compressor or air system parts.
- Let system cool down before touching or servicing.
- To handle hot parts, use proper tools and/or wear heavy, insulated welding gloves and clothing to prevent burns.



HOT METAL from air arc cutting and gouging can cause fire or explosion.

- Do not cut or gouge near flammables.
- Watch for fire; keep extinguisher nearby.

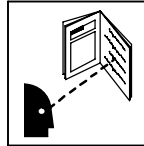

READ INSTRUCTIONS.

- Read Owner's Manual before installing, operating, or servicing unit.
- Use only genuine replacement parts from the manufacturer.
- Perform maintenance and service according to the Owner's Manuals, industry standards, and national, state, and local codes.

1-6. Additional Symbols For Installation, Operation, And Maintenance



FIRE OR EXPLOSION hazard.

- Do not install or place unit on, over, or near combustible surfaces.
- Do not install unit near flammables.
- Do not overload building wiring – be sure power supply system is properly sized, rated, and protected to handle this unit.

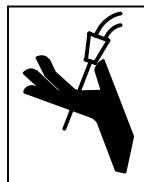

WELDING WIRE can cause injury.

- Do not press gun trigger until instructed to do so.
- Do not point gun toward any part of the body, other people, or any metal when threading welding wire.



FALLING UNIT can cause injury.

- Use lifting eye to lift unit and properly installed accessories only, NOT gas cylinders. Do not exceed maximum lift eye weight rating (see Specifications).
- Lift and support unit only with proper equipment and correct procedures.
- If using lift forks to move unit, be sure forks are long enough to extend beyond opposite side of unit.

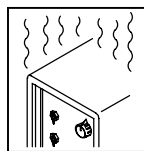

OVERUSE can cause OVERHEATING.

- Allow cooling period; follow rated duty cycle.
- Reduce current or reduce duty cycle before starting to weld again.
- Do not block or filter airflow to unit.

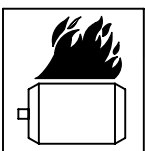

OVERHEATING can damage motors.

- Turn off or unplug equipment before starting or stopping engine.
- Do not let low voltage and frequency caused by low engine speed damage electric motors.
- Do not connect 50 or 60 Hertz motors to the 100 Hertz receptacle where applicable.

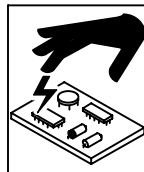

STATIC (ESD) can damage PC boards.

- Put on grounded wrist strap BEFORE handling boards or parts.
- Use proper static-proof bags and boxes to store, move, or ship PC boards.

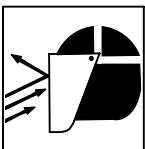

FLYING SPARKS can cause injury.

- Wear a face shield to protect eyes and face.
- Shape tungsten electrode only on grinder with proper guards in a safe location wearing proper face, hand, and body protection.
- Sparks can cause fires — keep flammables away.



TILTING OF TRAILER can cause injury.

- Use tongue jack or blocks to support weight.
- Properly install welding generator onto trailer according to instructions supplied with trailer.



MOVING PARTS can cause injury.

- Keep away from moving parts.
- Keep away from pinch points such as drive rolls.

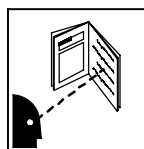

READ INSTRUCTIONS.

- Read Owner's Manual before using or servicing unit.
- Use only genuine replacement parts from the manufacturer.
- Perform maintenance and service according to the Owner's Manuals, industry standards, and national, state, and local codes.

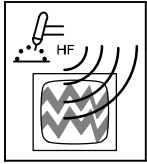

H.F. RADIATION can cause interference.

- High-frequency (H.F.) can interfere with radio navigation, safety services, computers, and communications equipment.
- Have only qualified persons familiar with electronic equipment perform this installation.
- The user is responsible for having a qualified electrician promptly correct any interference problem resulting from the installation.
- If notified by the FCC about interference, stop using the equipment at once.
- Have the installation regularly checked and maintained.
- Keep high-frequency source doors and panels tightly shut, keep spark gaps at correct setting, and use grounding and shielding to minimize the possibility of interference.

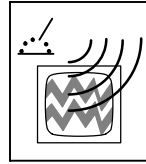

ARC WELDING can cause interference.

- Electromagnetic energy can interfere with sensitive electronic equipment such as micro-processors, computers, and computer-driven equipment such as robots.
- Be sure all equipment in the welding area is electromagnetically compatible.
- To reduce possible interference, keep weld cables as short as possible, close together, and down low, such as on the floor.
- Locate welding operation 100 meters from any sensitive electronic equipment.
- Be sure this welding machine is installed and grounded according to this manual.
- If interference still occurs, the user must take extra measures such as moving the welding machine, using shielded cables, using line filters, or shielding the work area.

1-7. California Proposition 65 Warnings

- ⚠** Welding or cutting equipment produces fumes or gases which contain chemicals known to the State of California to cause birth defects and, in some cases, cancer. (California Health & Safety Code Section 25249.5 et seq.)
- ⚠** Battery posts, terminals and related accessories contain lead and lead compounds, chemicals known to the State of California to cause cancer and birth defects or other reproductive harm. Wash hands after handling.

For Gasoline Engines:

- ⚠** Engine exhaust contains chemicals known to the State of California to cause cancer, birth defects, or other reproductive harm.

For Diesel Engines:

- ⚠** Diesel engine exhaust and some of its constituents are known to the State of California to cause cancer, birth defects, and other reproductive harm.

1-8. Principal Safety Standards

Safety in Welding, Cutting, and Allied Processes, ANSI Standard Z49.1, from Global Engineering Documents (phone: 1-877-413-5184, website: www.global.ihs.com).

Recommended Safe Practices for the Preparation for Welding and Cutting of Containers and Piping, American Welding Society Standard AWS F4.1, from Global Engineering Documents (phone: 1-877-413-5184, website: www.global.ihs.com).

National Electrical Code, NFPA Standard 70, from National Fire Protection Association, P.O. Box 9101, Quincy, MA 02269-9101 (phone: 617-770-3000, website: www.nfpa.org and www.sparky.org).

Safe Handling of Compressed Gases in Cylinders, CGA Pamphlet P-1, from Compressed Gas Association, 4221 Walney Road, 5th Floor, Chantilly, VA 20151 (phone: 703-788-2700, website: www.cganet.com).

Code for Safety in Welding and Cutting, CSA Standard W117.2, from Canadian Standards Association, Standards Sales, 5060 Mississauga, Ontario, Canada L4W 5N5 (phone: 800-463-6727 or in Toronto 416-747-4044, website: www.csa-international.org).

Safe Practice For Occupational And Educational Eye And Face Protection, ANSI Standard Z87.1, from American National Standards Institute, 25 West 43rd Street, New York, NY 10036-8002 (phone: 212-642-4900, website: www.ansi.org).

Standard for Fire Prevention During Welding, Cutting, and Other Hot Work, NFPA Standard 51B, from National Fire Protection Association, P.O. Box 9101, Quincy, MA 02269-9101 (phone: 617-770-3000, website: www.nfpa.org).

For Standards about hydraulic systems, contact the National Fluid Power Association, Publications Department, 3333 North Mayfair Road, Suite 211, Milwaukee, WI 53222-3219 (phone: (414) 778-3344, website: www.nfpa.com).

OSHA, Occupational Safety and Health Standards for General Industry, Title 29, Code of Federal Regulations (CFR), Part 1910, Subpart Q, and Part 1926, Subpart J, from U.S. Government Printing Office, Superintendent of Documents, P.O. Box 371954, Pittsburgh, PA 15250-7954 (phone: 1-866-512-1800) (there are 10 Regional Offices—phone for Region 5, Chicago, is 312-353-2220, website: www.osha.gov).

1-9. EMF Information

Considerations About Welding And The Effects Of Low Frequency Electric And Magnetic Fields

Welding current, as it flows through welding cables, will cause electromagnetic fields. There has been and still is some concern about such fields. However, after examining more than 500 studies spanning 17 years of research, a special blue ribbon committee of the National Research Council concluded that: "The body of evidence, in the committee's judgment, has not demonstrated that exposure to power-frequency electric and magnetic fields is a human-health hazard." However, studies are still going forth and evidence continues to be examined. Until the final conclusions of the research are reached, you may wish to minimize your exposure to electromagnetic fields when welding or cutting.

To reduce magnetic fields in the workplace, use the following procedures:

1. Keep cables close together by twisting or taping them, or using a cable cover.
2. Arrange cables to one side and away from the operator.
3. Do not coil or drape cables around your body.
4. Keep welding power source and cables as far away from operator as practical.
5. Connect work clamp to workpiece as close to the weld as possible.

About Implanted Medical Devices:

Implanted Medical Device wearers should consult their doctor and the device manufacturer before performing or going near arc welding, spot welding, gouging, plasma arc cutting, or induction heating operations. If cleared by your doctor, then following the above procedures is recommended.

SECTION 2 – CONSIGNES DE SÉCURITÉ – LIRE AVANT UTILISATION

rom_2008-08fre

! Se protéger, ainsi que toute autre personne travaillant sur les lieux, contre les étincelles et le métal chaud.

2-1. Signification des symboles



DANGER! – Indique une situation dangereuse qui si on l'évite pas peut donner la mort ou des blessures graves. Les dangers possibles sont montrés par les symboles joints ou sont expliqués dans le texte.



Indique une situation dangereuse qui si on l'évite pas peut donner la mort ou des blessures graves. Les dangers possibles sont montrés par les symboles joints ou sont expliqués dans le texte.

NOTE – Indique des déclarations pas en relation avec des blessures personnelles.

Indique des instructions spécifiques.



Ce groupe de symboles veut dire Avertissement! Attention! DANGER DE CHOC ELECTRIQUE, PIECES EN MOUVEMENT, et PIECES CHAUDES. Consulter les symboles et les instructions ci-dessous y afférant pour les actions nécessaires afin d'éviter le danger.

2-2. Dangers relatifs au soudage à l'arc



Les symboles présentés ci-après sont utilisés tout au long du présent manuel pour attirer votre attention et identifier les risques de danger. Lorsque vous voyez un symbole, soyez vigilant et suivez les directives mentionnées afin d'éviter tout danger. Les consignes de sécurité présentées ci-après ne font que résumer l'information contenue dans les normes de sécurité énumérées à la section 2-8. Veuillez lire et respecter toutes ces normes de sécurité.



L'installation, l'utilisation, l'entretien et les réparations ne doivent être confiés qu'à des personnes qualifiées.



Au cours de l'utilisation, tenir toute personne à l'écart et plus particulièrement les enfants.



UN CHOC ÉLECTRIQUE peut tuer.

Un simple contact avec des pièces électriques peut provoquer une électrocution ou des blessures graves. L'électrode et le circuit de soudage sont sous tension

dès que l'appareil est sur ON. Le circuit d'entrée et les circuits internes de l'appareil sont également sous tension à ce moment-là. En soudage semi-automatique ou automatique, le fil, le dévidoir, le logement des galets d'entraînement et les pièces métalliques en contact avec le fil de soudage sont sous tension. Des matériels mal installés ou mal mis à la terre présentent un danger.

- Ne jamais toucher les pièces électriques sous tension.
- Porter des gants et des vêtements de protection secs ne comportant pas de trous.
- S'isoler de la pièce et de la terre au moyen de tapis ou d'autres moyens isolants suffisamment grands pour empêcher le contact physique éventuel avec la pièce ou la terre.
- Ne pas se servir de source électrique à courant électrique dans les zones humides, dans les endroits confinés ou là où on risque de tomber.
- Se servir d'une source électrique à courant électrique UNIQUEMENT si le procédé de soudage le demande.
- Si l'utilisation d'une source électrique à courant électrique s'avère nécessaire, se servir de la fonction de télécommande si l'appareil en est équipé.
- Des précautions de sécurité supplémentaires sont requises dans des environnements à risque comme: les endroits humides ou lorsque l'on porte des vêtements mouillés; sur des structures métalliques au sol, grillages et échafaudages; dans des positions assises, à genoux et allongées; ou quand il y a un risque important de contact accidentel avec la pièce ou le sol. Dans ces cas utiliser les appareils suivants dans l'ordre de préférence: 1) un poste à souder DC semi-automatique de type CV (MIG/MAG), 2) un poste

à souder manuel (électrode enrobée) DC, 3) un poste à souder manuel AC avec tension à vide réduite. Dans la plupart des cas, un poste courant continu de type CV est recommandé. Et, ne pas travailler seul!

- Couper l'alimentation ou arrêter le moteur avant de procéder à l'installation, à la réparation ou à l'entretien de l'appareil. Déverrouiller l'alimentation selon la norme OSHA 29 CFR 1910.147 (voir normes de sécurité).
- Installer et mettre à la terre correctement cet appareil conformément à son manuel d'utilisation et aux codes nationaux, provinciaux et municipaux.
- Toujours vérifier la terre du cordon d'alimentation – Vérifier et s'assurer que le fil de terre du cordon d'alimentation est bien raccordé à la borne de terre du sectionneur ou que la fiche du cordon est raccordée à une prise correctement mise à la terre.
- En effectuant les raccordements d'entrée fixer d'abord le conducteur de mise à la terre approprié et contre-vérifier les connexions.
- Les câbles doivent être exempts d'humidité, d'huile et de graisse; protégez-les contre les étincelles et les pièces métalliques chaudes.
- Vérifier fréquemment le cordon d'alimentation pour voir s'il n'est pas endommagé ou dénudé – remplacer le cordon immédiatement s'il est endommagé – un câble dénudé peut provoquer une électrocution.
- Mettre l'appareil hors tension quand on ne l'utilise pas.
- Ne pas utiliser des câbles usés, endommagés, de grosseur insuffisante ou mal épissés.
- Ne pas enrouler les câbles autour du corps.
- Si la pièce soudée doit être mise à la terre, le faire directement avec un câble distinct – ne pas utiliser le connecteur de pièce ou le câble de retour.
- Ne pas toucher l'électrode quand on est en contact avec la pièce, la terre ou une électrode provenant d'une autre machine.
- Ne pas toucher des porte électrodes connectés à deux machines en même temps à cause de la présence d'une tension à vide doublée.
- N'utiliser qu'un matériel en bon état. Réparer ou remplacer sur-le-champ les pièces endommagées. Entretenir l'appareil conformément à ce manuel.
- Porter un harnais de sécurité quand on travaille en hauteur.
- Maintenir solidement en place tous les panneaux et capots.
- Fixer le câble de retour de façon à obtenir un bon contact métal-métal avec la pièce à souder ou la table de travail, le plus près possible de la soudure.
- Isoler la pince de masse quand pas mis à la pièce pour éviter le contact avec tout objet métallique.

Une tension DC importante subsiste à l'intérieur des onduleurs après avoir coupé l'alimentation.

- Couper l'alimentation du poste et décharger les condensateurs d'entrée comme indiqué dans la Section Maintenance avant de toucher des composants.



DES PIÈCES CHAUDES peuvent provoquer des brûlures graves.

- Ne pas toucher à mains nues les parties chaudes.
- Prévoir une période de refroidissement avant de travailler à l'équipement.
- Ne pas toucher aux pièces chaudes, utiliser les outils recommandés et porter des gants de soudage et des vêtements épais pour éviter les brûlures.

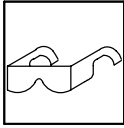

DES PIÈCES DE METAL ou DES SALETES peuvent provoquer des blessures dans les yeux.

- Le soudage, l'écaillage, le passage de la pièce à la brosse en fil de fer, et le meulage génèrent des étincelles et des particules métalliques volantes. Pendant la période de refroidissement des soudures, elles risquent de projeter du laitier.
- Porter des lunettes de sécurité avec écrans latéraux ou un écran facial.



LES FUMÉES ET LES GAZ peuvent être dangereux.

Le soudage génère des fumées et des gaz. Leur inhalation peut être dangereux pour votre santé.

- Eloigner votre tête des fumées. Ne pas respirer les fumées.
- À l'intérieur, ventiler la zone et/ou utiliser une ventilation forcée au niveau de l'arc pour l'évacuation des fumées et des gaz de soudage.
- Si la ventilation est médiocre, porter un respirateur anti-vapeurs approuvé.
- Lire et comprendre les spécifications de sécurité des matériaux (MSDS) et les instructions du fabricant concernant les métaux, les consommables, les revêtements, les nettoyants et les dégraissateurs.
- Travailler dans un espace fermé seulement s'il est bien ventilé ou en portant un respirateur à alimentation d'air. Demander toujours à un surveillant dûment formé de se tenir à proximité. Des fumées et des gaz de soudage peuvent déplacer l'air et abaisser le niveau d'oxygène provoquant des blessures ou des accidents mortels. S'assurer que l'air de respiration ne présente aucun danger.
- Ne pas souder dans des endroits situés à proximité d'opérations de dégraissage, de nettoyage ou de pulvérisation. La chaleur et les rayons de l'arc peuvent réagir en présence de vapeurs et former des gaz hautement toxiques et irritants.
- Ne pas souder des métaux munis d'un revêtement, tels que l'acier galvanisé, plaqué en plomb ou au cadmium à moins que le revêtement n'ait été enlevé dans la zone de soudure, que l'endroit soit bien ventilé, et en portant un respirateur à alimentation d'air. Les revêtements et tous les métaux renfermant ces éléments peuvent dégager des fumées toxiques en cas de soudage.



LES ACCUMULATIONS DE GAZ risquent de provoquer des blessures ou même la mort.

- Fermer l'alimentation du gaz protecteur en cas de non utilisation.
- Veiller toujours à bien aérer les espaces confinés ou se servir d'un respirateur d'adduction d'air homologué.

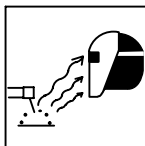

LES RAYONS DE L'ARC peuvent provoquer des brûlures dans les yeux et sur la peau.

Le rayonnement de l'arc du procédé de soudage génère des rayons visibles et invisibles intenses (ultraviolets et infrarouges) susceptibles de provoquer des brûlures dans les yeux et sur la peau. Des étincelles sont projetées pendant le soudage.

- Porter un casque de soudage approuvé muni de verres filtrants appropriés pour protéger visage et yeux pendant le soudage (voir ANSI Z49.1 et Z87.1 énuméré dans les normes de sécurité).
- Porter des lunettes de sécurité avec écrans latéraux même sous votre casque.
- Avoir recours à des écrans protecteurs ou à des rideaux pour protéger les autres contre les rayonnements les éblouissements et les étincelles ; prévenir toute personne sur les lieux de ne pas regarder l'arc.
- Porter des vêtements confectionnés avec des matières résistantes et ignifuges (cuir, coton lourd ou laine) et des bottes de protection.

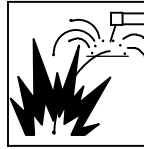

LE SOUDAGE peut provoquer un incendie ou une explosion.

Le soudage effectué sur des conteneurs fermés tels que des réservoirs, tambours ou des conduites peut provoquer leur éclatement. Des étincelles peuvent être projetées de l'arc de soudure. La projection d'étincelles, des pièces chaudes et des équipements chauds peut provoquer des incendies et des brûlures. Le contact accidentel de l'électrode avec des objets métalliques peut provoquer des étincelles, une explosion, un surchauffement ou un incendie. Avant de commencer le soudage, vérifier et s'assurer que l'endroit ne présente pas de danger.

- Déplacer toutes les substances inflammables à une distance de 10,7 m de l'arc de soudage. En cas d'impossibilité les recouvrir soigneusement avec des protections homologués.
- Ne pas souder dans un endroit où des étincelles peuvent tomber sur des substances inflammables.
- Se protéger et d'autres personnes de la projection d'étincelles et de métal chaud.
- Des étincelles et des matériaux chauds du soudage peuvent facilement passer dans d'autres zones en traversant de petites fissures et des ouvertures.
- Surveiller tout déclenchement d'incendie et tenir un extincteur à proximité.
- Le soudage effectué sur un plafond, plancher, paroi ou séparation peut déclencher un incendie de l'autre côté.
- Ne pas effectuer le soudage sur des conteneurs fermés tels que des réservoirs, tambours, ou conduites, à moins qu'ils n'aient été préparés correctement conformément à AWS F4.1 (voir les normes de sécurité).
- Ne soudez pas si l'air ambiant est chargé de particules, gaz, ou vapeurs inflammables (vapeur d'essence, par exemple).
- Brancher le câble de masse sur la pièce la plus près possible de la zone de soudage pour éviter le transport du courant sur une longue distance par des chemins inconnus éventuels en provoquant des risques d'électrocution, d'étincelles et d'incendie.
- Ne pas utiliser le poste de soudage pour dégeler des conduites gelées.
- En cas de non utilisation, enlever la baguette d'électrode du porte-électrode ou couper le fil à la pointe de contact.
- Porter des vêtements de protection dépourvus d'huile tels que des gants en cuir, une chemise en matériau lourd, des pantalons sans revers, des chaussures hautes et un couvre chef.
- Avant de souder, retirer toute substance combustible de vos poches telles qu'un allumeur au butane ou des allumettes.
- Une fois le travail achevé, assurez-vous qu'il ne reste aucune trace d'étincelles incandescentes ni de flammes.
- Utiliser exclusivement des fusibles ou coupe-circuits appropriés. Ne pas augmenter leur puissance; ne pas les ponter.
- Suivre les recommandations dans OSHA 1910.252(a)(2)(iv) et NFPA 51B pour les travaux à chaud et avoir de la surveillance et un extincteur à proximité.

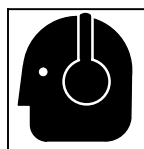

LE BRUIT peut affecter l'ouïe.

Le bruit des processus et des équipements peut affecter l'ouïe.

- Porter des protections approuvés pour les oreilles si le niveau sonore est trop élevé.



LES CHAMPS MAGNETIQUES peuvent affecter des implants médicaux.

- Porteur de simulateur cardiaque ou autre implants médicaux, rester à distance.
- Les porteurs d'implants doivent d'abord consulter leur médecin avant de s'approcher des opérations de soudage à l'arc, de soudage par points, de gougeage, du coupage plasma ou de chauffage par induction.

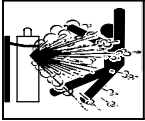

Si des BOUTEILLES sont endommagées, elles pourront exploser.

Des bouteilles de gaz protecteur contiennent du gaz sous haute pression. Si une bouteille est endommagée, elle peut exploser. Du fait que les bouteilles de gaz font normalement partie du procédé de soudage, les manipuler avec précaution.

- Protéger les bouteilles de gaz comprimé d'une chaleur excessive, des chocs mécaniques, des dommages physiques, du laitier, des flammes ouvertes, des étincelles et des arcs.

- Placer les bouteilles debout en les fixant dans un support stationnaire ou dans un porte-bouteilles pour les empêcher de tomber ou de se renverser.
- Tenir les bouteilles éloignées des circuits de soudage ou autres circuits électriques.
- Ne jamais placer une torche de soudage sur une bouteille à gaz.
- Une électrode de soudage ne doit jamais entrer en contact avec une bouteille.
- Ne jamais souder une bouteille pressurisée – risque d'explosion.
- Utiliser seulement des bouteilles de gaz protecteur, régulateurs, tuyaux et raccords convenables pour cette application spécifique; les maintenir ainsi que les éléments associés en bon état.
- Ne pas tenir la tête en face de la sortie en ouvrant la soupape de la bouteille.
- Maintenir le chapeau de protection sur la soupape, sauf en cas d'utilisation ou de branchement de la bouteille.
- Utiliser les équipements corrects, les bonnes procédures et suffisamment de personnes pour soulever et déplacer les bouteilles.
- Lire et suivre les instructions sur les bouteilles de gaz comprimé, l'équipement connexe et le dépliant P-1 de la CGA (Compressed Gas Association) mentionné dans les principales normes de sécurité.

2-3. Dangers existant en relation avec le moteur

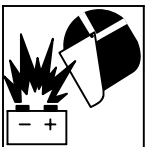

L'EXPLOSION DE LA BATTERIE peut RENDRE AVEUGLE.

- Toujours porter une protection faciale, des gants en caoutchouc et vêtements de protection lors d'une intervention sur la batterie.
- Arrêter le moteur avant de débrancher ou de brancher les câbles de batterie.
- Eviter de provoquer des étincelles avec les outils en travaillant sur la batterie.
- Ne pas utiliser le poste de soudage pour charger les batteries ou des véhicules de démarrage rapide.
- Observer la polarité correcte (+ et -) sur les batteries.
- Débrancher le câble négatif (-) en premier lieu. Le rebrancher en dernier lieu.

- Ne pas approcher les mains, cheveux, vêtements lâches et outils des organes mobiles.
- Remettre en place les portes, panneaux, recouvrements ou dispositifs de protection à la fin des travaux d'entretien et avant de mettre le moteur en marche.
- Avant d'intervenir, déposer les bougies ou injecteurs pour éviter la mise en route accidentelle du moteur.
- Bloquer le volant moteur pour éviter sa rotation lors d'une intervention sur le générateur.



LES ÉTINCELLES À L'ÉCHAPPEMENT peuvent provoquer un incendie.

- Empêcher les étincelles d'échappement du moteur de provoquer un incendie.
- Utiliser uniquement un pare-étincelles approuvé – voir codes en vigueur.



LE CARBURANT MOTEUR peut provoquer un incendie ou une explosion.

- Arrêter le moteur avant de vérifier le niveau de carburant ou de faire le plein.
- Ne pas faire le plein en fumant ou proche d'une source d'étincelles ou d'une flamme nue.
- Ne pas faire le plein de carburant à ras bord; prévoir de l'espace pour son expansion.
- Faire attention de ne pas renverser de carburant. Nettoyer tout carburant renversé avant de faire démarrer le moteur.
- Jeter les chiffons dans un récipient ignifuge.
- Toujours garder le pistolet en contact avec le réservoir lors du remplissage.



DES PIÈCES CHAUDES peuvent provoquer des brûlures graves.

- Ne pas toucher à mains nues les parties chaudes.
- Prévoir une période de refroidissement avant de travailler à l'équipement.
- Ne pas toucher aux pièces chaudes, utiliser les outils recommandés et porter des gants de soudage et des vêtements épais pour éviter les brûlures.



Les PIÈCES MOBILES peuvent causer des blessures.

- Ne pas approcher les mains des ventilateurs, courroies et autres pièces en mouvement.
- Maintenir fermés et verrouillés les portes, panneaux, recouvrements et dispositifs de protection.
- Arrêter le moteur avant d'installer ou brancher l'appareil.
- Lorsque cela est nécessaire pour des travaux d'entretien et de dépannage, faire retirer les portes, panneaux, recouvrements ou dispositifs de protection uniquement par du personnel qualifié.
- Pour empêcher tout démarrage accidentel pendant les travaux d'entretien, débrancher le câble négatif (-) de batterie de la borne.

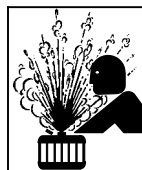

LA VAPEUR ET LE LIQUIDE DE REFROIDISSEMENT CHAUD peuvent provoquer des brûlures.

- Il est préférable de vérifier le liquide de refroidissement une fois le moteur refroidi pour éviter de se brûler.
- Toujours vérifier le niveau de liquide de refroidissement dans le vase d'expansion (si présent), et non dans le radiateur (sauf si précisé autrement dans la section maintenance du manuel du moteur).
- Si le moteur est chaud et que le liquide doit être vérifié, opérer comme suivant.
- Mettre des lunettes de sécurité et des gants, placer un torchon sur le bouchon du radiateur.
- Dévisser le bouchon légèrement et laisser la vapeur s'échapper avant d'enlever le bouchon.



L'utilisation d'un groupe autonome à l'intérieur PEUT VOUS TUER EN QUELQUES MINUTES.

- Les fumées d'un groupe autonome contient du monoxyde de carbone. C'est un poison invisible et inodore.
- JAMAIS utiliser dans une maison ou garage, même avec les portes et fenêtres ouvertes.
- Uniquement utiliser à l'EXTERIEUR, loin des portes, fenêtres et bouches aération.

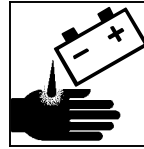

L'ACIDE DE LA BATTERIE peut provoquer des brûlures dans les YEUX et sur la PEAU.

- Ne pas renverser la batterie.
- Remplacer une batterie endommagée.
- Rincer immédiatement les yeux et la peau à l'eau.



LA CHALEUR DU MOTEUR peut provoquer un incendie.

- Ne pas placer l'appareil sur, au-dessus ou à proximité de surfaces inflammables.
- Tenir à distance les produits inflammables de l'échappement.

2-4. Dangers liés à l'hydraulique

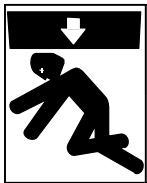

Les ÉQUIPEMENTS HYDRAULIQUES peuvent provoquer des blessures ou même la mort.

- Une installation ou une utilisation incorrecte de cet appareil pourrait conduire à des dégâts matériels ou corporels. Seul un personnel qualifié est autorisé à installer, faire fonctionner et réparer cet appareil conformément à son manuel d'utilisation, aux normes industrielles et aux codes nationaux, d'état ou locaux.
- Ne pas dépasser le débit nominal ou la capacité de la pompe hydraulique ou de tout équipement du circuit hydraulique. Concevoir le circuit hydraulique de telle sorte que la défaillance d'un composant hydraulique ne risque pas de provoquer un accident matériel ou corporel.
- Avant d'intervenir sur le circuit hydraulique, couper l'alimentation électrique, verrouiller et étiqueter l'appareil, détendre la pression et s'assurer que le circuit hydraulique ne peut être remis sous pression par inadvertance.
- Ne pas intervenir sur le circuit hydraulique lorsque l'appareil fonctionne. Seul un personnel qualifié et appliquant les consignes du fabricant est autorisé à le faire.
- Ne pas modifier ou altérer la pompe hydraulique ou les équipements fournis par le fabricant. Ne pas débrancher, désactiver ou neutraliser les équipements de sécurité du circuit hydraulique.
- Utiliser uniquement des composants et accessoires homologués par le fabricant.
- Se tenir à l'écart de tout point présentant un danger de pincement ou d'écrasement créé par l'équipement raccordé au circuit hydraulique.
- Ne pas intervenir sous ou autour d'un équipement qui n'est soutenu que par la pression hydraulique. Soutenir l'équipement de façon appropriée par un moyen mécanique.

- Pour intervenir sur un circuit hydraulique, porter un équipement de protection tel que des lunettes de sécurité, des gants de cuir, une chemise et un pantalon en tissu résistant, des chaussures montantes et une coiffe.
- Pour rechercher des fuites, utiliser un morceau de papier ou de carton, jamais les mains nues. En cas de détection de fuite, ne pas utiliser l'équipement.
- Le LIQUIDE HYDRAULIQUE est INFLAMMABLE. Ne pas intervenir sur des composants hydrauliques à proximité d'étincelles ou de flammes; ne pas fumer à proximité de liquide hydraulique.
- Remettre les portes, panneaux, recouvrements ou dispositifs de protection quand l'entretien est terminé et avant de mettre en marche l'appareil.
- En cas de pénétration d'un QUELCONQUE liquide dans la peau, celui-ci doit être retiré chirurgicalement sous quelques heures par un médecin familiarisé avec ce type de blessure, faute de quoi la gangrène pourrait apparaître.



Les PIÈCES MOBILES peuvent causer des blessures.

- Rester à l'écart des ventilateurs, courroies et rotors.
- Maintenir fermés et verrouillés les portes, panneaux, recouvrements et dispositifs de protection.
- Ne pas approcher les mains, cheveux, vêtements lâches et outils des organes mobiles.
- Avant d'intervenir sur le circuit hydraulique, couper l'alimentation électrique, verrouiller et étiqueter l'appareil, détendre la pression et s'assurer que le circuit hydraulique ne peut être remis sous pression par inadvertance.
- Demander seulement à un personnel qualifié d'enlever les dispositifs de sécurité ou les recouvrements pour effectuer, s'il y a lieu, des travaux d'entretien et de dépannage.
- Remettre en place les portes, panneaux, recouvrements ou dispositifs de protection à la fin des travaux d'entretien et avant de mettre le moteur en marche.

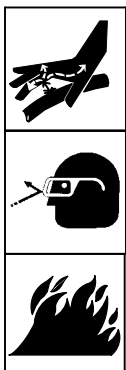

Le LIQUIDE HYDRAULIQUE risque de provoquer des blessures ou même la mort.

- Avant d'intervenir sur le circuit hydraulique, couper l'alimentation électrique, verrouiller et étiqueter l'appareil, détendre la pression et s'assurer que le circuit hydraulique ne peut être remis sous pression par inadvertance.
- Détendre la pression avant de débrancher ou de brancher des canalisations hydrauliques.
- Avant d'utiliser l'appareil, contrôler les composants du circuit hydraulique, les branchements et les flexibles en recherchant tout signe de détérioration, de fuite et d'usure.



Les PIÈCES ET LIQUIDES CHAUDS peuvent provoquer des brûlures graves.

- Ne pas toucher les pièces chaudes à main nue ni laisser des liquides chauds entrer en contact avec la peau.
- Prévoir une période de refroidissement avant d'intervenir sur l'équipement.
- Ne pas toucher aux pièces chaudes, utiliser les outils recommandés et porter des gants de soudage et des vêtements épais pour éviter les brûlures.

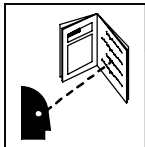

LIRE LES INSTRUCTIONS.

- Lire le manuel d'utilisation avant d'installer, d'utiliser ou d'intervenir sur l'appareil.
- N'utiliser que les pièces de rechange recommandées par le constructeur.
- Effectuer l'entretien en respectant les manuels d'utilisation, les normes industrielles et les codes nationaux, d'état et locaux.

2-5. Dangers liés à l'air comprimé

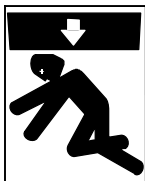

Un ÉQUIPEMENT PNEUMATIQUE risque de provoquer des blessures ou même la mort.

- Une installation ou une utilisation incorrecte de cet appareil pourrait conduire à des dégâts matériels ou corporels. Seul un personnel qualifié est autorisé à installer, utiliser et entretenir cet appareil conformément à son manuel d'utilisation, aux normes industrielles et aux codes nationaux, d'état ou locaux.
- Ne pas dépasser le débit nominal ou la capacité du compresseur ou de tout équipement du circuit d'air comprimé. Concevoir le circuit d'air comprimé de telle sorte que la défaillance d'un composant ne risque pas de provoquer un accident matériel ou corporel.
- Avant d'intervenir sur le circuit d'air comprimé, couper l'alimentation électrique, verrouiller et étiqueter l'appareil, détendre la pression et s'assurer que le circuit d'air ne peut être mis sous pression par inadvertance.
- Ne pas intervenir sur le circuit d'air comprimé lorsque l'appareil fonctionne. Seul un personnel qualifié est autorisé, et appliquant les consignes du fabricant.
- Ne pas modifier ou altérer le compresseur ou les équipements fournis par le fabricant. Ne pas débrancher, désactiver ou neutraliser les équipements de sécurité du circuit d'air comprimé.
- Utiliser uniquement des composants et accessoires homologués par le fabricant.
- Se tenir à l'écart de tout point présentant un danger de pincement ou d'écrasement créé par l'équipement raccordé au circuit d'air comprimé.
- Ne pas intervenir sous ou autour d'un équipement qui n'est soutenu que par la pression pneumatique. Soutenir l'équipement de façon appropriée par un moyen mécanique.

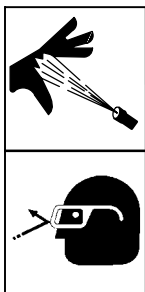

L'AIR COMPRIMÉ risque de provoquer des blessures ou même la mort.

- Avant d'intervenir sur le circuit d'air comprimé, couper l'alimentation électrique, verrouiller et étiqueter l'appareil, détendre la pression et s'assurer que le circuit d'air ne peut être mis sous pression par inadvertance.
- Détendre la pression avant de débrancher ou de brancher des canalisations d'air.
- Avant d'utiliser l'appareil, contrôler les composants du circuit d'air comprimé, les branchements et les flexibles en recherchant tout signe de détérioration, de fuite et d'usure.
- Ne pas diriger un jet d'air vers soi-même ou vers autrui.
- Pour intervenir sur un circuit d'air comprimé, porter un équipement de protection tel que des lunettes de sécurité, des gants de cuir, une chemise et un pantalon en tissu résistant, des chaussures montantes et une coiffe.

- Pour rechercher des fuites, utiliser de l'eau savonneuse ou un détecteur à ultrasons, jamais les mains nues. En cas de détection de fuite, ne pas utiliser l'équipement.
- Remettre les portes, panneaux, recouvrements ou dispositifs de protection quand l'entretien est terminé et avant de mettre en marche l'appareil.
- En cas d'injection d'air dans la peau ou le corps, demander immédiatement une assistance médicale.



L'INHALATION D'AIR COMPRIMÉ risque de provoquer des blessures ou même la mort.

- Ne pas inhaler d'air comprimé.
- Utiliser l'air comprimé uniquement pour découper ou gouger ainsi que pour l'outillage pneumatique.



Les PIÈCES MOBILES peuvent causer des blessures.

- Rester à l'écart des ventilateurs, courroies et rotors.
- Maintenir fermés et verrouillés les portes, panneaux, recouvrements et dispositifs de protection.
- Ne pas approcher les mains, cheveux, vêtements lâches et outils des organes mobiles.
- Avant d'intervenir sur le circuit d'air comprimé, couper l'alimentation électrique, verrouiller et étiqueter l'appareil, détendre la pression et s'assurer que le circuit d'air ne peut être mis sous pression par inadvertance.
- Demander seulement à un personnel qualifié d'enlever les dispositifs de sécurité ou les recouvrements pour effectuer, s'il y a lieu, des travaux d'entretien et de dépannage.
- Remettre en place les portes, panneaux, recouvrements ou dispositifs de protection à la fin des travaux d'entretien et avant de mettre le moteur en marche.

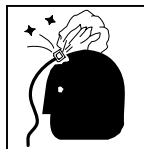

Une PRESSION D'AIR RÉSIDUELLE ET DES FLEXIBLES QUI FOUETTENT risquent de provoquer des blessures.

- Détendre la pression pneumatique des outils et circuits avant d'entretenir, ajouter ou changer des accessoires et avant d'ouvrir le bouchon de vidange ou de remplissage d'huile du compresseur.



DES PIÈCES CHAUDES peuvent provoquer des brûlures graves.

- Ne pas toucher de pièces chaudes du compresseur ou du circuit d'air.
- Laisser refroidir le circuit avant de toucher ou entretenir des pièces.
- Ne pas toucher aux pièces chaudes, utiliser les outils recommandés et porter des gants de soudage et des vêtements épais pour éviter les brûlures.



Le MÉTAL CHAUD provenant du découpage ou du gougeage à l'arc risque de provoquer un incendie ou une explosion.

- Ne pas découper ou gouger à proximité de produits inflammables.
- Attention aux risques d'incendie: tenir un extincteur à proximité.

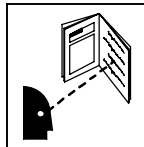

LIRE LES INSTRUCTIONS.

- Lire le manuel d'utilisation avant d'installer, d'utiliser ou d'intervenir sur l'appareil.
- N'utiliser que les pièces de rechange recommandées par le constructeur.
- Effectuer l'entretien en respectant les manuels d'utilisation, les normes industrielles et les codes nationaux, d'état et locaux.

2-6. Dangers supplémentaires en relation avec l'installation, le fonctionnement et la maintenance



Risque D'INCENDIE OU D'EXPLOSION.

- Ne pas placer l'appareil sur, au-dessus ou à proximité de surfaces inflammables.
- Ne pas installer l'appareil à proximité de produits inflammables.
- Ne pas surcharger l'installation électrique – s'assurer que l'alimentation est correctement dimensionnée et protégée avant de mettre l'appareil en service.



LES FILS DE SOUDAGE peuvent provoquer des blessures.

- Ne pas appuyer sur la gâchette avant d'en avoir reçu l'instruction.
- Ne pas diriger le pistolet vers soi, d'autres personnes ou toute pièce mécanique en engageant le fil de soudage.



LA CHUTE DE L'APPAREIL peut blesser.

- Utiliser l'anneau de levage pour lever l'appareil et les accessoires correctement installés seuls, PAS les bouteilles de gaz. Ne pas dépasser le poids nominal maximal de l'œilleton (voir les spécifications).
- Ne lever et ne soutenir l'appareil qu'avec de l'équipement approprié et en suivant les procédures adéquates.
- En utilisant des fourches de levage pour déplacer l'unité, s'assurer que les fourches sont suffisamment longues pour dépasser du côté opposé de l'appareil.

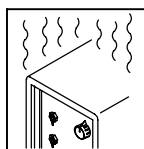

L'EMPLOI EXCESSIF peut SURCHAUFFER L'ÉQUIPEMENT.

- Laisser l'équipement refroidir ; respecter le facteur de marche nominal.
- Réduire le courant ou le facteur de marche avant de poursuivre le soudage.
- Ne pas obstruer les passages d'air du poste.

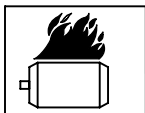

LE SURCHAUFFEMENT peut endommager le moteur électrique.

- Arrêter ou déconnecter l'équipement avant de démarrer ou d'arrêter le moteur.
- Ne pas laisser tourner le moteur trop lentement sous risque d'endommager le moteur électrique à cause d'une tension et d'une fréquence trop faibles.
- Ne pas brancher de moteur de 50 ou de 60 Hz à la prise de 100 Hz, s'il y a lieu.

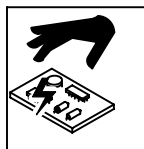

LES CHARGES ÉLECTROSTATIQUES peuvent endommager les circuits imprimés.

- Établir la connexion avec la barrette de terre avant de manipuler des cartes ou des pièces.
- Utiliser des pochettes et des boîtes antistatiques pour stocker, déplacer ou expédier des cartes de circuits imprimés.

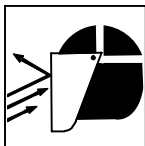

LES ÉTINCELLES VOLANTES risquent de provoquer des blessures.

- Porter un écran facial pour protéger le visage et les yeux.
- Affûter l'électrode au tungstène uniquement à la meuleuse dotée de protecteurs. Cette manœuvre est à exécuter dans un endroit sûr lorsque l'on porte l'équipement homologué de protection du visage, des mains et du corps.
- Les étincelles risquent de causer un incendie – éloigner toute substance inflammable.



UNE REMORQUE QUI BASCULE peut entraîner des blessures.

- Utiliser les supports de la remorque ou des blocs pour soutenir le poids.
- Installer convenablement le poste sur la remorque comme indiqué dans le manuel s'y rapportant.



DES ORGANES MOBILES peuvent provoquer des blessures.

- Ne pas s'approcher des organes mobiles.
- Ne pas s'approcher des points de coincement tels que des rouleaux de commande.

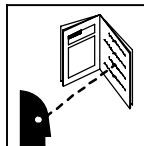

LIRE LES INSTRUCTIONS.

- Lisez le manuel d'instructions avant l'utilisation ou la maintenance de l'appareil.
- N'utiliser que les pièces de rechange recommandées par le constructeur.
- Effectuer l'entretien en respectant les manuels d'utilisation, les normes industrielles et les codes nationaux, d'état et locaux.

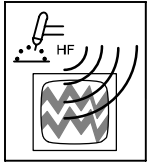

LE RAYONNEMENT HAUTE FRÉQUENCE (H.F.) risque de provoquer des interférences.

- Le rayonnement haute fréquence (H.F.) peut provoquer des interférences avec les équipements de radio-navigation et de communication, les services de sécurité et les ordinateurs.
- Demander seulement à des personnes qualifiées familiarisées avec des équipements électroniques de faire fonctionner l'installation.
- L'utilisateur est tenu de faire corriger rapidement par un électricien qualifié les interférences résultant de l'installation.
- Si le FCC signale des interférences, arrêter immédiatement l'appareil.
- Effectuer régulièrement le contrôle et l'entretien de l'installation.
- Maintenir soigneusement fermés les portes et les panneaux des sources de haute fréquence, maintenir les éclateurs à une distance correcte et utiliser une terre et un blindage pour réduire les interférences éventuelles.

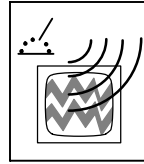

LE SOUDAGE À L'ARC risque de provoquer des interférences.

- L'énergie électromagnétique risque de provoquer des interférences pour l'équipement électronique sensible tel que les ordinateurs et l'équipement commandé par ordinateur tel que les robots.
- Veiller à ce que tout l'équipement de la zone de soudage soit compatible électromagnétiquement.
- Pour réduire la possibilité d'interférence, maintenir les câbles de soudage aussi courts que possible, les grouper, et les poser aussi bas que possible (ex. par terre).
- Veiller à souder à une distance de 100 mètres de tout équipement électronique sensible.
- Veiller à ce que ce poste de soudage soit posé et mis à la terre conformément à ce mode d'emploi.
- En cas d'interférences après avoir pris les mesures précédentes, il incombe à l'utilisateur de prendre des mesures supplémentaires telles que le déplacement du poste, l'utilisation de câbles blindés, l'utilisation de filtres de ligne ou la pose de protecteurs dans la zone de travail.

2-7. Proposition californienne 65 Avertissements

⚠ Les équipements de soudage et de coupage produisent des fumées et des gaz qui contiennent des produits chimiques dont l'État de Californie reconnaît qu'ils provoquent des malformations congénitales et, dans certains cas, des cancers. (Code de santé et de sécurité de Californie, chapitre 25249.5 et suivants)

⚠ Les batteries, les bornes et autres accessoires contiennent du plomb et des composés à base de plomb, produits chimiques dont l'État de Californie reconnaît qu'ils provoquent des cancers et des malformations congénitales ou autres problèmes de procréation. Se laver les mains après manipulation.

Pour les moteurs à essence :

⚠ Les gaz d'échappement des moteurs contiennent des produits chimiques dont l'État de Californie reconnaît qu'ils provoquent des cancers et des malformations congénitales ou autres problèmes de procréation.

Pour les moteurs diesel :

⚠ Les gaz d'échappement des moteurs diesel et certains de leurs composants sont reconnus par l'État de Californie comme provoquant des cancers et des malformations congénitales ou autres problèmes de procréation.

2-8. Principales normes de sécurité

Safety in Welding, Cutting, and Allied Processes, ANSI Standard Z49.1, de Global Engineering Documents (téléphone : 1-877-413-5184, site Internet : www.global.ihs.com).

Recommended Safe Practices for the Preparation for Welding and Cutting of Containers and Piping, American Welding Society Standard AWS F4.1 de Global Engineering Documents (téléphone : 1-877-413-5184, site Internet : www.global.ihs.com).

National Electrical Code, NFPA Standard 70, de National Fire Protection Association, P.O. Box 9101, Quincy, MA 02269-9101 (téléphone : 617-770-3000, site Internet : www.nfpa.org).

Safe Handling of Compressed Gases in Cylinders, CGA Pamphlet P-1, de Compressed Gas Association, 4221 Walney Road, 5th Floor, Chantilly, VA 20151 (téléphone : 703-788-2700, site Internet : www.cganet.com).

Code for Safety in Welding and Cutting, CSA Standard W117.2, de Canadian Standards Association, 5060 Mississauga, Ontario, Canada L4W 5NS (téléphone : 800-463-6727 ou à Toronto 416-747-4044, site Internet : www.csa-international.org).

Safe Practice For Occupational And Educational Eye And Face Protection, ANSI Standard Z87.1, de American National Standards Institute, 11 West 43rd Street, New York, NY 10036-8002 (téléphone : 212-642-4900, site Internet : www.ansi.org).

Standard for Fire Prevention During Welding, Cutting, and Other Hot Work, NFPA Standard 51B, de National Fire Protection Association, P.O. Box 9101, Quincy, MA 02269-9101 (téléphone : 617-770-3000, site Internet : www.nfpa.org).

Pour les normes relatives aux circuits hydrauliques, contacter: National Fluid Power Association, Publications Department, 3333 North Mayfair Road, Suite 211, Milwaukee, WI 53222-3219 (tél.: (414) 778-3344, site web: www.nfpa.com).

OSHA, Occupational Safety and Health Standards for General Industry, Title 29, Code of Federal Regulations (CFR), Part 1910, Subpart Q, and Part 1926, Subpart J, de U.S. Government Printing Office, Superintendent of Documents, P.O. Box 371954, Pittsburgh, PA 15250-7954 (téléphone : 1-866-512-1800) (il y a 10 bureaux régionaux—le téléphone de la région 5, Chicago, est 312-353-2220, site Internet : www.osha.gov).

2-9. Information EMF

Considérations sur le soudage et les effets de basse fréquence et des champs magnétiques et électriques.

Le courant de soudage, pendant son passage dans les câbles de soudage, causera des champs électromagnétiques. Il y a eu et il y a encore un certain souci à propos de tels champs. Cependant, après avoir examiné plus de 500 études qui ont été faites pendant une période de recherche de 17 ans, un comité spécial ruban bleu du National Research Council a conclu : « L'accumulation de preuves, suivant le jugement du comité, n'a pas démontré que l'exposition aux champs magnétiques et champs électriques à haute fréquence représente un risque à la santé humaine ». Toutefois, des études sont toujours en cours et les preuves continuent à être examinées. En attendant que les conclusions finales de la recherche soient établies, il vous serait souhaitable de réduire votre exposition aux champs électromagnétiques pendant le soudage ou le coupage.

Pour réduire les champs magnétiques sur le poste de travail, appliquer les procédures suivantes :













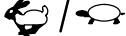







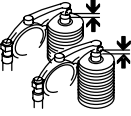

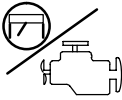









1. Garder les câbles ensemble, les torsader, les scotcher, ou les recouvrir d'une housse.
2. Disposer les câbles d'un côté et à distance de l'opérateur.
3. Ne pas courber pas et ne pas entourer pas les câbles autour de votre corps.
4. Garder le poste de soudage et les câbles le plus loin possible de vous.
5. Connecter la pince sur la pièce aussi près que possible de la soudure.

En ce qui concerne les implants médicaux :

Les porteurs d'implants doivent d'abord consulter leur médecin avant de s'approcher des opérations de soudage à l'arc, de soudage par points, de gougeage, du coupage plasma ou de chauffage par induction. Si le médecin approuve, il est recommandé de suivre les procédures précédentes.

SECTION 3 – DEFINITIONS

3-1. Symbol Definitions

	Stop Engine		Fast (Run, Weld/Power)		Fast/Slow (Run/Idle)		Slow (Idle)
	Start Engine		Panel/Local		Temperature		Fuel
	Engine Oil		Engine Choke		Check Valve Clearance		Battery (Engine)
	Engine		Read Operator's Manual	A	Amperes	V	Volts
	MIG (GMAW), Wire		Stick (SMAW)		TIG (GTAW)		Lift Arc TIG
+	Positive	—	Negative		Alternating Current (AC)		Direct Current (DC)
	Time	h	Hours	s	Seconds		Protective Earth (Ground)
	Do not switch while welding		Remote Receptacle		Work Connection	CC	Constant Current
	Wire Feed		Electrode Positive		Electrode Negative	CV	Constant Voltage
	Circuit Protector	F	Full	E	Empty		Output
	Air Compressor		Air Pressure				

SECTION 4 – SPECIFICATIONS

4-1. Weld, Power, And Engine Specifications

Welding Mode	Rated Welding Output	Maximum Open-Circuit Voltage	Weld Output Range	Generator Power Rating	Fuel Capacity	Engine
CC/DC	280 A, 32 V, 100% Duty Cycle	50	10 – 300 A	Continuous: 11 kVA/kW, 100/50 A, 120/240 V AC, 60 Hz, Single-Phase, Peak: 13 kVA/kW (w/Weld Contactor Off)	12 gal (45 L) Tank	Kohler CH-750 Air-Cooled, Two-Cylinder, Four-Cycle, 30 HP Gasoline Engine w/Electronic Governor
CV/DC	300 A, 32 V, 100% Duty Cycle 350 A, 32 V, 60% Duty Cycle	35	13 – 35 V			
CC/AC	200 A, 25 V, 60% Duty Cycle	60	10 – 225 A			

4-2. Air Compressor Specifications

Compressor Type	Air Output At 100 psi* 100% Duty Cycle	Pressure	Safety Relief Valve Setting	Air Compressor Oil Capacity*
Rotary Screw	26 scfm @ 3600 RPM 21 scfm @ 3000 RPM 17 scfm 2400 RPM *100 psi = 689 kPa	Range: 80–150 psi (552–1034 kPa)	Auto Shutoff: 165 psi (1138 kPa) Pressure Relief: 200 psi (1379 kPa)	1.75 qt (1.7 L) * Use Only Mobil 1 Synthetic ATF Oil Or Compressor May Be Damaged

4-3. Sound Level Table – 7 Meter (23 Ft) (Reference SAE J2101)

	Idle Speed 2400 RPM	Weld Speed 3000 RPM	3600 RPM
Air Compressor On	73.5 dB	76.4 dB	81.6 dB
Air Compressor Off	70.9 dB	N/A	77.7 dB
Weld Load	N/A	76.4 dB	81.6 dB

4-4. Dimensions, Weights, and Operating Angles

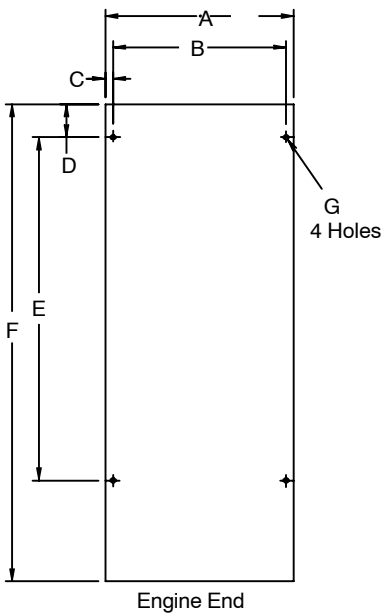

Dimensions	
Height	34-1/4 in. (870 mm) (To Top Of Air Cleaner)
Width	20 in. (508 mm)
Depth	59-5/8 in. (1514 mm)
A	20 in. (508 mm)
B	16-1/2 in. (419 mm)
C	1-3/4 in. (44 mm)
D	6-1/16 in. (154 mm)
E	32-3/4 in. (832 mm)
F	59-5/8 in. (1514 mm)
G	13/32 in. (10 mm) Dia.
Weight	
Without Fuel: 805 lb (365 kg)	
With Fuel: 880 lb (399 kg)	
Lifting Eye Weight Rating	
1000 lb (453 kg)	



G
4 Holes

800 426



-  Do not exceed tilt angles or engine could be damaged or unit could tip.
-  Do not move or operate unit where it could tip.
-  Do not operate suspended from lifting eye.

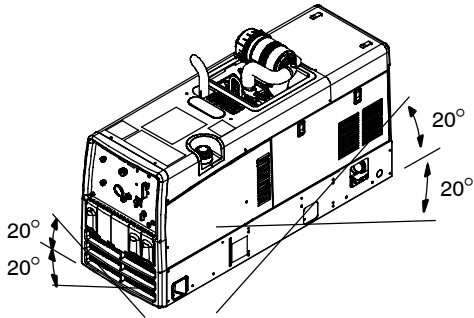

804 951-A

Notes

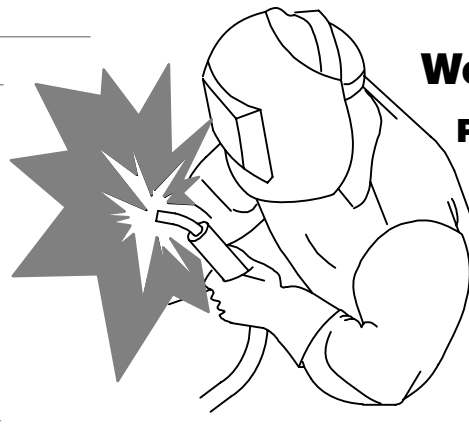

Work like a Pro!
Pros weld and cut safely. Read the safety rules at the beginning of this manual.

4-5. Fuel Consumption Curves

A. Welding

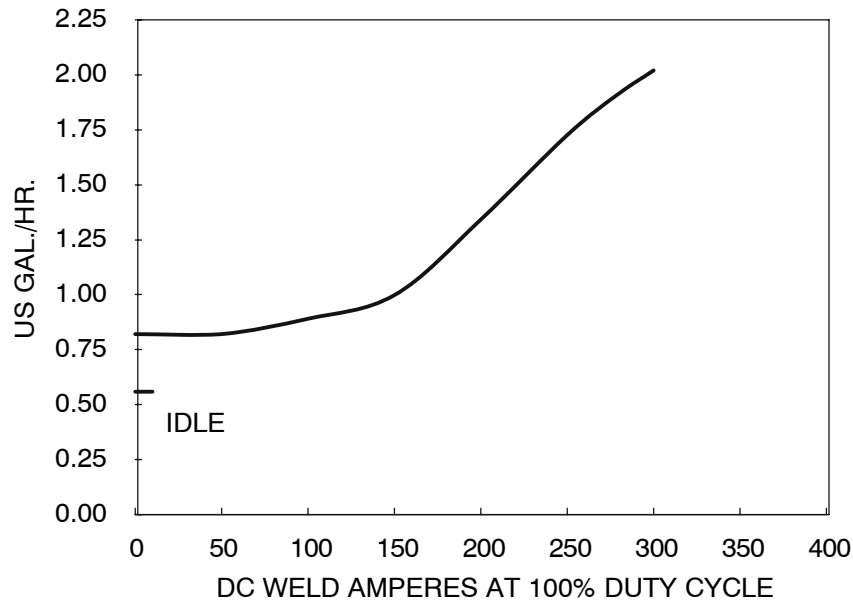

B. Auxiliary Power

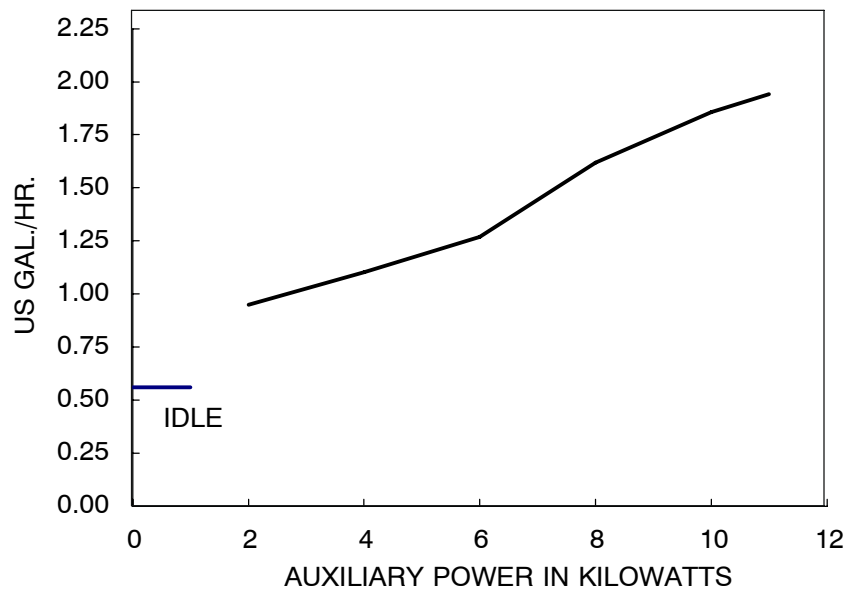

C. Air Compressor

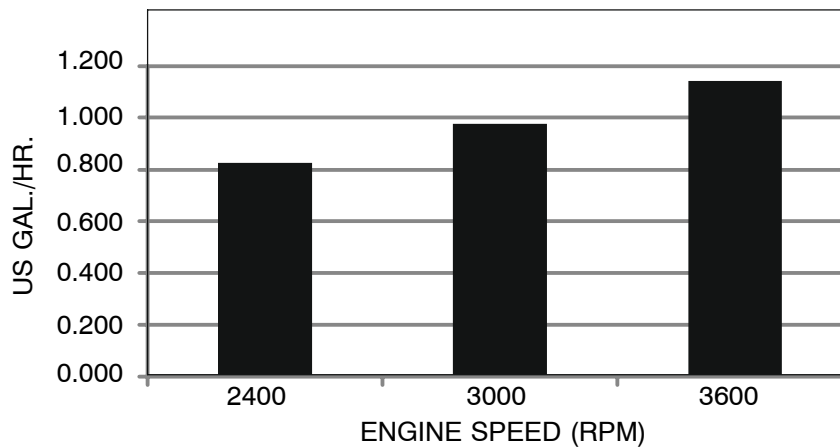

4-6. Generator Power Curve

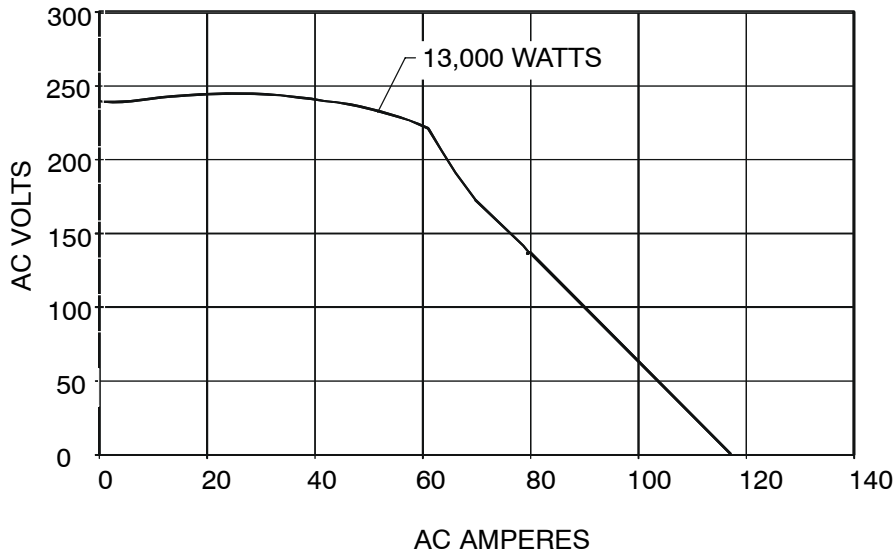

The AC generator power curve shows the generator power available in amperes at the receptacles.

Tools and motors are designed to operate within 10% of 120/240 VAC.

235 695-A

4-7. Duty Cycle



100% Duty Cycle at 280 Amperes DC

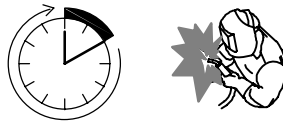

Continuous Welding

Duty cycle is the percentage of 10 minutes that unit can weld at rated load without overheating.

NOTICE - Exceeding duty cycle can damage unit and void warranty.

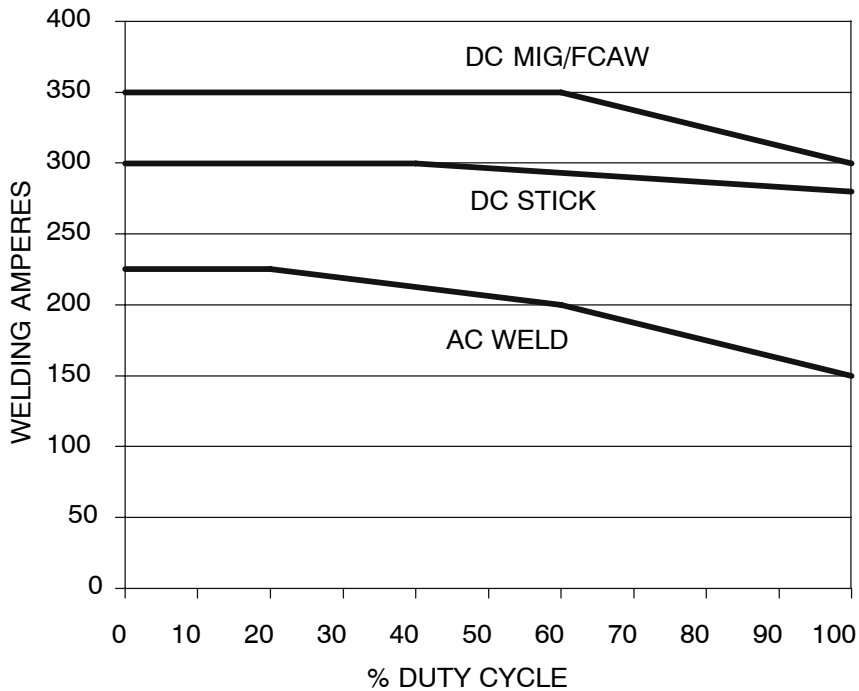

242 683

4-8. Stick And MIG Mode Volt-Ampere Curves

A. CC/DC Stick Mode

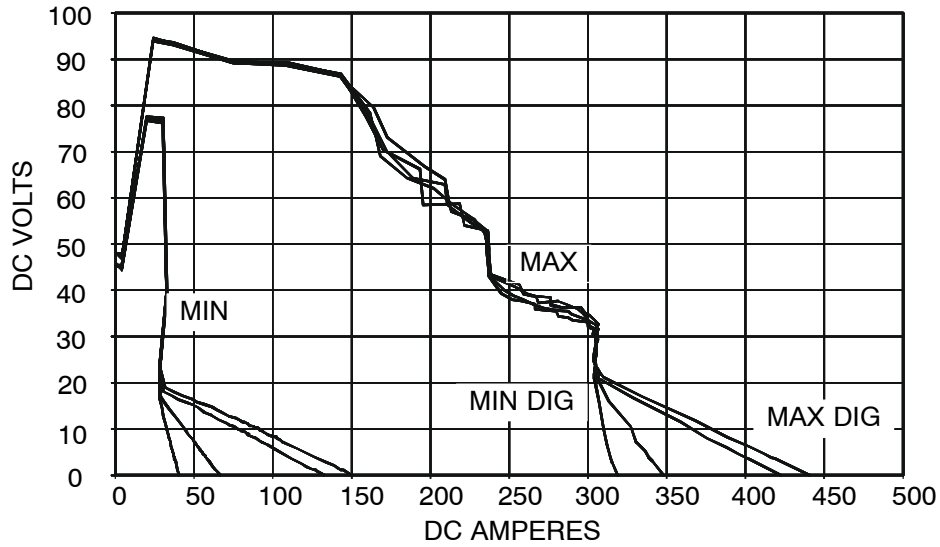

The volt-ampere curves show the minimum and maximum voltage and amperage output capabilities of the welding generator. Curves of other settings fall between the curves shown.

B. CC/AC STICK Mode

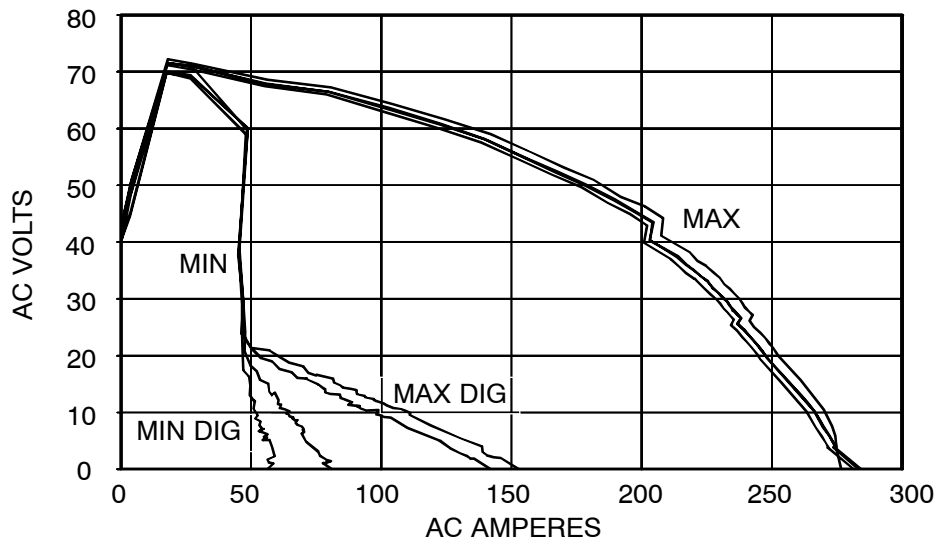

C. CV/DC MIG Mode

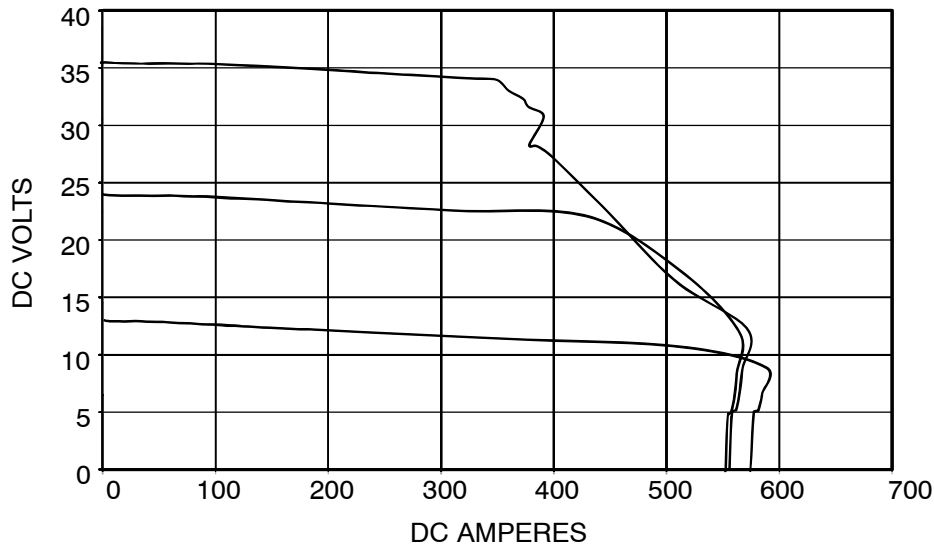

235 696-A / 235 697-A / 235 700-A

4-9. TIG Mode Volt-Ampere Curves

The volt-ampere curves show the minimum and maximum voltage and amperage output capabilities of the welding generator. Curves of other settings fall between the curves shown.

A. CC/AC TIG Mode

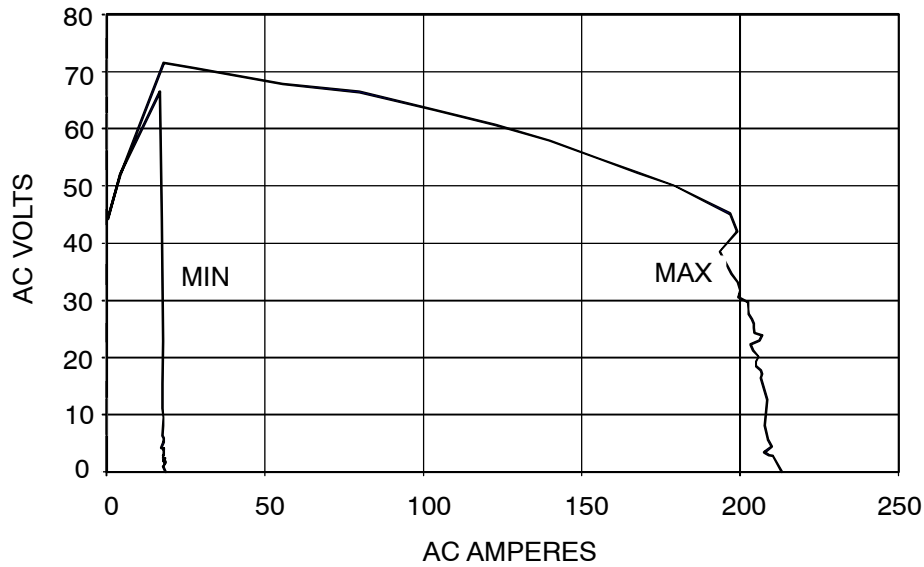

B. CC/DC TIG Mode

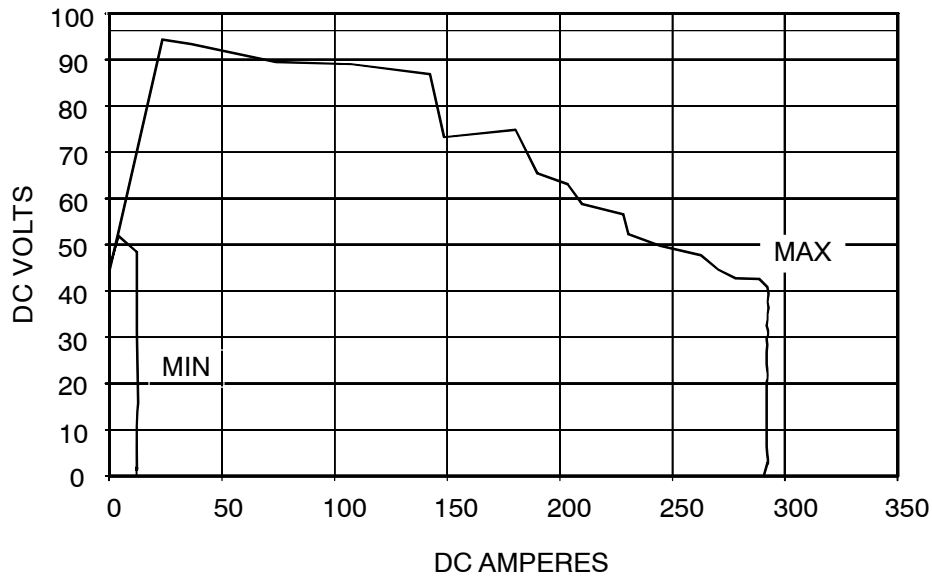

SECTION 5 – INSTALLATION

5-1. Serial Number And Rating Label Location

The serial number and rating information for this product is located on the rear panel. Use rating label to determine rated output. For future reference, write serial number in space provided on back cover of this manual.

5-2. Installing Welding Generator



Movement

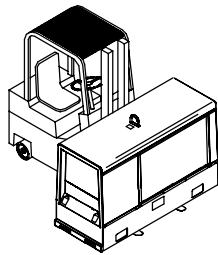

OR

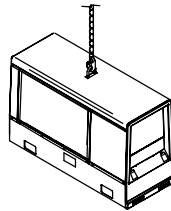

- Do not move or operate unit where it could tip.
- Do not lift unit from end.
- Do not weld on base. Welding on base can cause fuel tank fire or explosion. Bolt unit down using holes provided in base.
- Always securely fasten welding generator onto transport vehicle or trailer and comply with all DOT and other applicable codes.

NOTICE – Do not install unit where air flow is restricted or engine may over-heat.

See Section 4-4 for lifting eye rating.

Location / Airflow Clearance

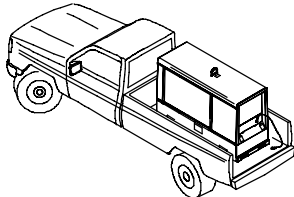

OR

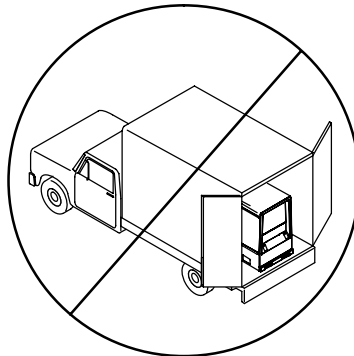
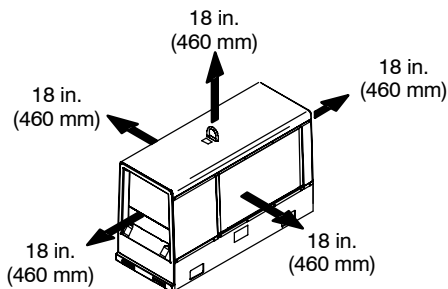
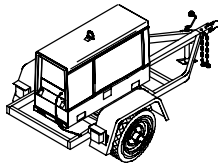

Mounting:

- Do not mount unit by supporting the base only at the four mounting holes. Do not use flexible mounts. Use cross-supports to adequately support unit and prevent damage to base.

1 Cross-Supports

Mount unit on flat surface or use cross-supports to support base.

Mounting

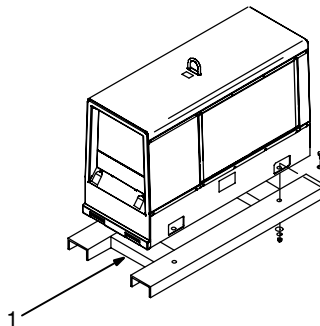
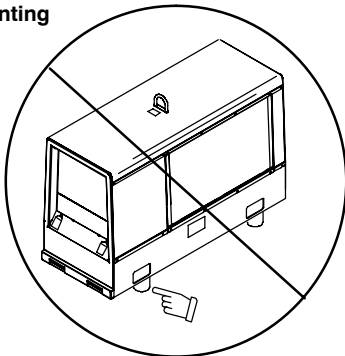

install2 2008-01 – Ref. 800 652 / Ref. 800 477-A / 803 274-A / 804 712

5-3. Grounding Generator To Truck Or Trailer Frame

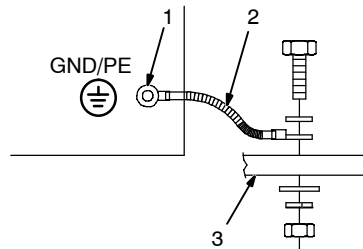
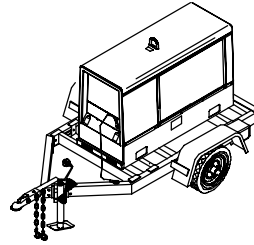
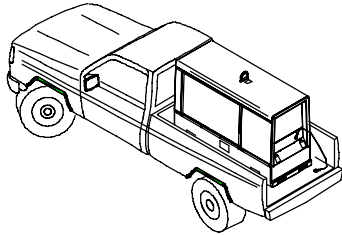

⚠ Always ground generator frame to vehicle frame to prevent electric shock and static electricity hazards.

⚠ Also see AWS Safety & Health Fact Sheet No. 29, Grounding of Portable And Vehicle Mounted Welding Generators.

⚠ Bed liners, shipping skids, and some running gear insulate the welding generator from the vehicle frame. Always connect a ground wire from the generator equipment grounding terminal to bare metal on the vehicle frame as shown.

⚠ If unit does not have GFCI receptacles, use GFCI-protected extension cord.

- 1 Equipment Grounding Terminal (On Front Panel)
- 2 Grounding Cable (Not Supplied)
- 3 Metal Vehicle Frame

Connect cable from equipment ground terminal to metal vehicle frame. Use #10 AWG or larger insulated copper wire.

⚠ *Electrically bond generator frame to vehicle frame by metal-to-metal contact.*

rot_grnd 2008-01 – 800 652-D

5-4. Engine Prestart Checks

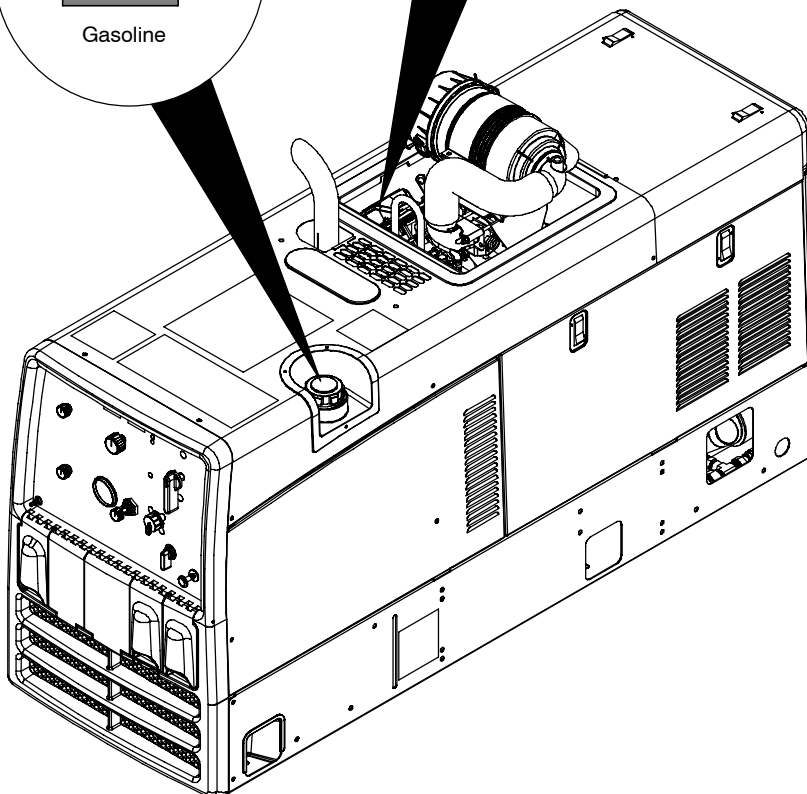
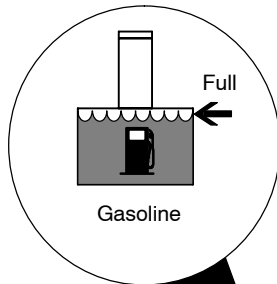
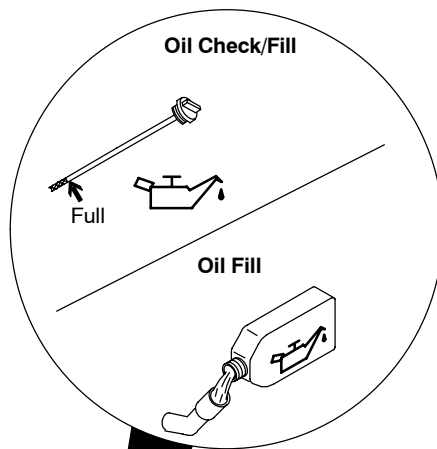
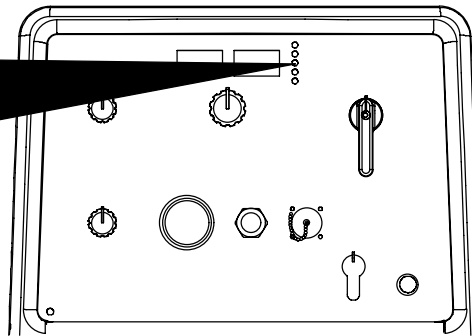
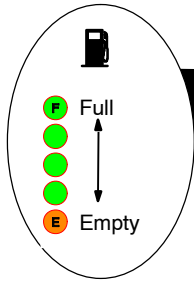
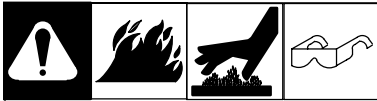

Check all fluids daily. Engine must be cold and on a level surface. Unit is shipped with 10W30 engine oil.

☞ Follow run-in procedure in engine manual.

☞ This unit has a low oil pressure shutdown switch. However, some conditions may cause engine damage before the engine shuts down. Check oil level often and do not use the oil pressure shutdown system to monitor oil level.

Fuel

Add fresh fuel before starting engine the first time (see maintenance label for specifications). Always leave filler neck empty to allow room for expansion. Check fuel level on a cold engine before use each day.

To check fuel level, turn Engine Control switch to Auto Speed position. LED's indicate fuel level in tank.

Engine Oil

☞ Do not exceed the "Full" mark on the oil level dipstick. The fuel pump may operate erratically if crankcase is overfilled.

After fueling, check oil with unit on level surface. If oil is not up to full mark on dipstick, add oil (see maintenance label).

Use front panel meters to determine hours until next recommended oil change (see Section 9-1).

☞ For cold weather starting information, see Section 6-2.

Keep battery in good condition. Store battery in warm area.

Use correct grade oil for cold weather.

5-5. Compressor Prestart Checks

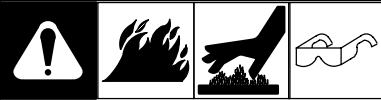

Primary Oil Fill/Check

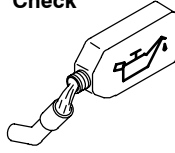

☞ Use only Mobil 1 Synthetic ATF oil.

Check Oil

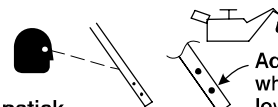

Add 12 oz. when below lower hole.

Screw in dipstick completely when checking level.

- Do not mix oil types.
- Do not open dipstick until unit has been off for 10 minutes.
- Do not open while running.
- Do not overfill.

Optional Oil Fill/Check

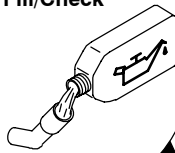

☞ Keep oil level in threaded area of fill pipe.

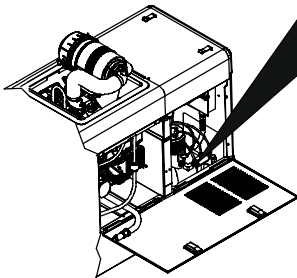

Check all fluids daily. Engine must be cold and on a level surface. Unit is shipped with oil.

Open top service door.

☞ Rear panel and compressor radiator removed to show compressor components.

☞ The compressor has a high oil temper-

ature shutdown. High oil temperature can be caused by low oil level or hot air recirculation.

☞ Screw dipstick in completely to accurately check oil level.

Check oil with unit on level surface. Check oil level at primary or optional oil fill/check location as shown. If oil is not up to full mark

on dipstick, add oil (see compressor maintenance label in Section 10-2).

Use front panel meters to determine hours until next recommended compressor oil change (see Section 7-1).

Inspect compressor air cleaner element and replace if dirty (see Section 10-3).

Close top service door.

236 200

5-6. Connecting the Battery

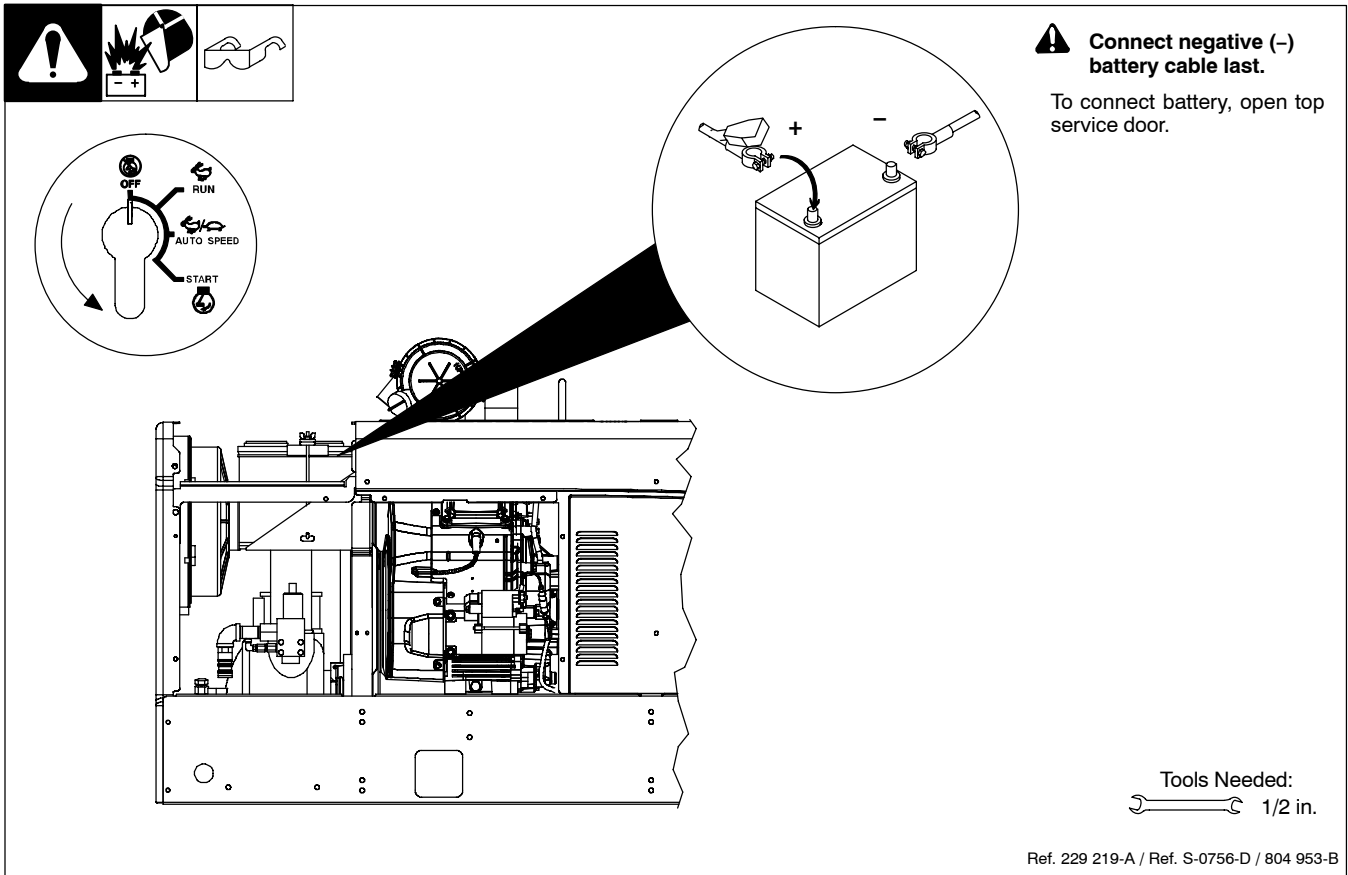

⚠ Connect negative (-) battery cable last.

To connect battery, open top service door.

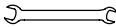
Tools Needed:
 1/2 in.

Ref. 229 219-A / Ref. S-0756-D / 804 953-B

5-7. Installing Exhaust Pipe

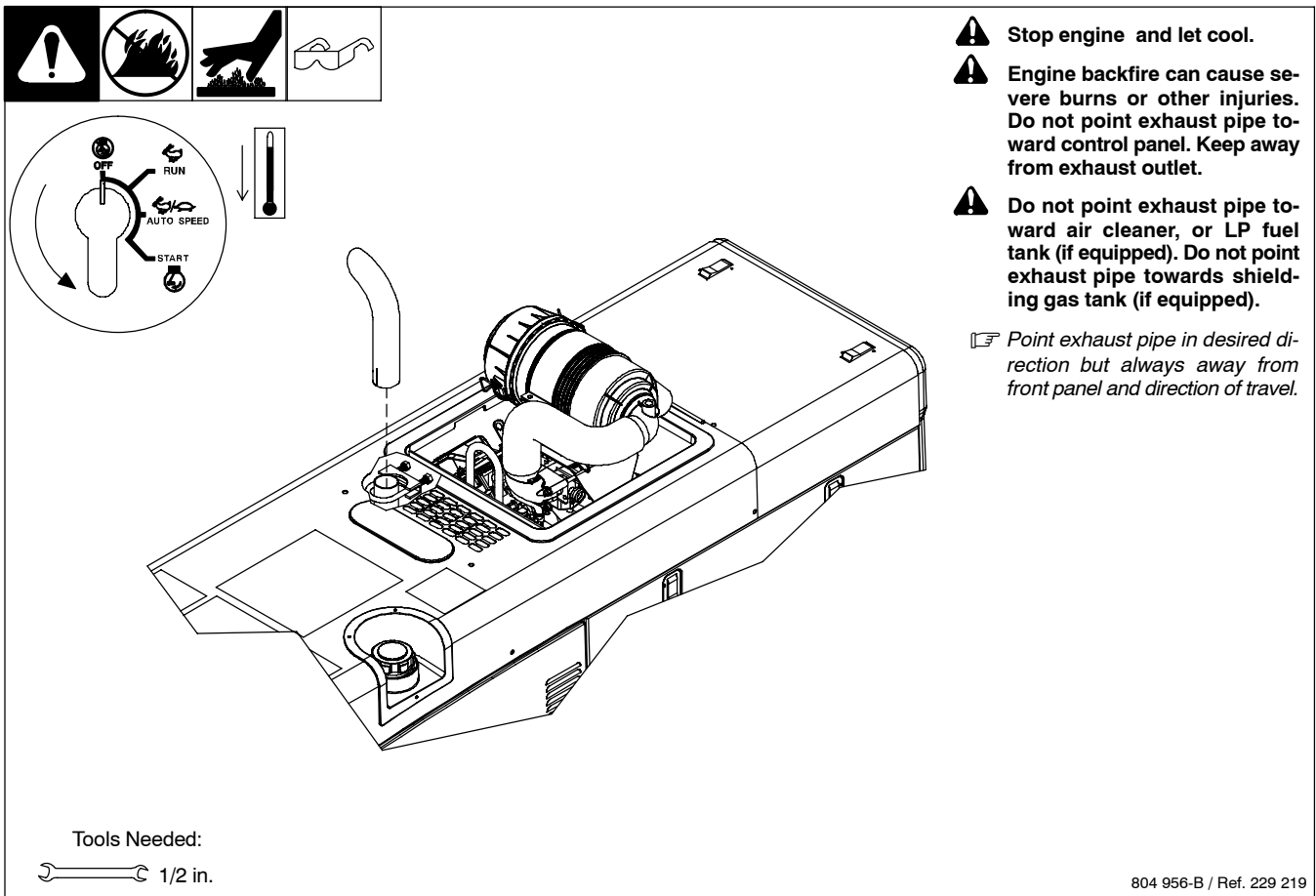

⚠ Stop engine and let cool.

⚠ Engine backfire can cause severe burns or other injuries. Do not point exhaust pipe toward control panel. Keep away from exhaust outlet.

⚠ Do not point exhaust pipe toward air cleaner, or LP fuel tank (if equipped). Do not point exhaust pipe towards shielding gas tank (if equipped).

☞ Point exhaust pipe in desired direction but always away from front panel and direction of travel.

Tools Needed:
 1/2 in.

804 956-B / Ref. 229 219

5-8. Weld Output Terminals

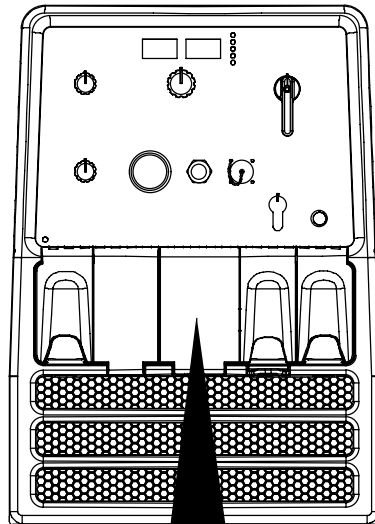
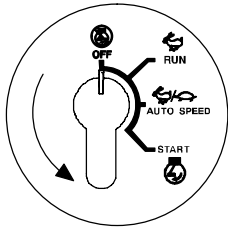

⚠ Stop engine.

⚠ Do not connect to CC and CV terminals at the same time.

- 1 Work Weld Output Terminal
- 2 Stick/TIG (CC) Weld Output Terminal
- 3 Wire (CV) Weld Output Terminal

For MIG welding, connect work cable to Work terminal and wire feeder cable to Wire (CV) terminal.

For Stick welding, connect work cable to Work terminal and electrode holder cable to Stick/TIG (CC) terminal.

For TIG welding, connect work cable to Stick/TIG (CC) terminal and electrode holder cable to Work terminal.

Tools Needed:

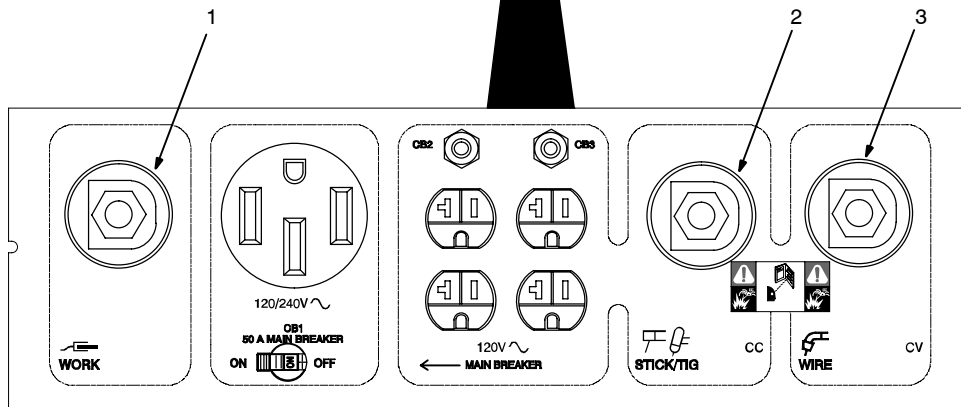
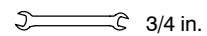

Ref. 229 219 / 803 778-B

5-9. Connecting To Weld Output Terminals

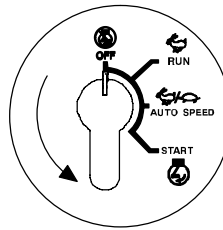

⚠ Stop engine.

⚠ Failure to properly connect weld cables may cause excessive heat and start a fire, or damage your machine.

ⓘ Do not place anything between weld cable terminal and copper bar. Make sure that the surfaces of the weld cable terminal and copper bar are clean.

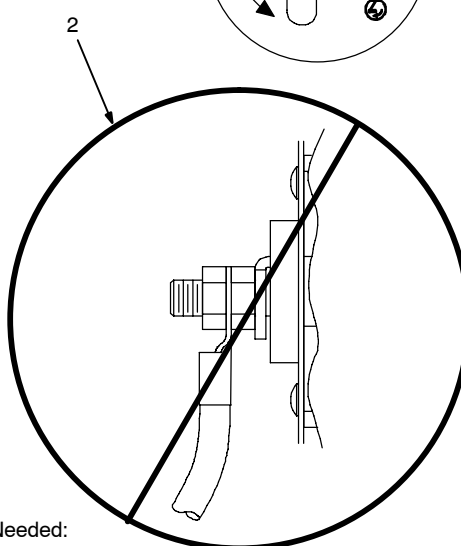
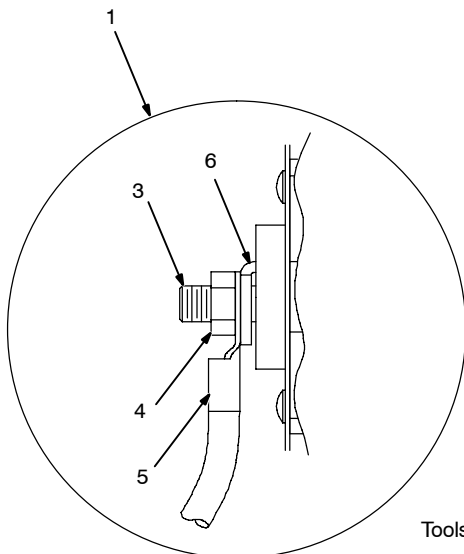

- 1 Correct Weld Cable Connection
- 2 Incorrect Weld Cable Connection
- 3 Weld Output Terminal
- 4 Supplied Weld Output Terminal Nut
- 5 Weld Cable Terminal
- 6 Copper Bar

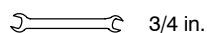

Remove supplied nut from weld output terminal. Slide weld cable terminal onto weld output terminal and secure with nut so that weld cable terminal is tight against copper bar.

Tools Needed:



803 778-B

5-10. Selecting Weld Cable Sizes*

	Welding Amperes	Weld Cable Size** and Total Cable (Copper) Length in Weld Circuit Not Exceeding***							
		100 ft (30 m) or Less		150 ft (45 m)	200 ft (60 m)	250 ft (70 m)	300 ft (90 m)	350 ft (105 m)	400 ft (120 m)
		10 – 60% Duty Cycle	60 – 100% Duty Cycle	10 – 100% Duty Cycle					
Weld Output Terminals  Stop engine before connecting to weld output terminals.  Do not use worn, damaged, undersized, or poorly spliced cables.	100	4 (20)	4 (20)	4 (20)	3 (30)	2 (35)	1 (50)	1/0 (60)	1/0 (60)
	150	3 (30)	3 (30)	2 (35)	1 (50)	1/0 (60)	2/0 (70)	3/0 (95)	3/0 (95)
	200	3 (30)	2 (35)	1 (50)	1/0 (60)	2/0 (70)	3/0 (95)	4/0 (120)	4/0 (120)
	250	2 (35)	1 (50)	1/0 (60)	2/0 (70)	3/0 (95)	4/0 (120)	2 ea. 2/0 (2x70)	2 ea. 2/0 (2x70)
	300	1 (50)	1/0 (60)	2/0 (70)	3/0 (95)	4/0 (120)	2 ea. 2/0 (2x70)	2 ea. 3/0 (2x95)	2 ea. 3/0 (2x95)
	350	1/0 (60)	2/0 (70)	3/0 (95)	4/0 (120)	2 ea. 2/0 (2x70)	2 ea. 3/0 (2x95)	2 ea. 3/0 (2x95)	2 ea. 4/0 (2x120)
	400	1/0 (60)	2/0 (70)	3/0 (95)	4/0 (120)	2 ea. 2/0 (2x70)	2 ea. 3/0 (2x95)	2 ea. 4/0 (2x120)	2 ea. 4/0 (2x120)



* This chart is a general guideline and may not suit all applications. If cables overheat, use next size larger cable.

**Weld cable size (AWG) is based on either a 4 volts or less drop or a current density of at least 300 circular mils per ampere.
() = mm² for metric use

***For distances longer than those shown in this guide, call a factory applications representative at 920-735-4505.

S-0007-F

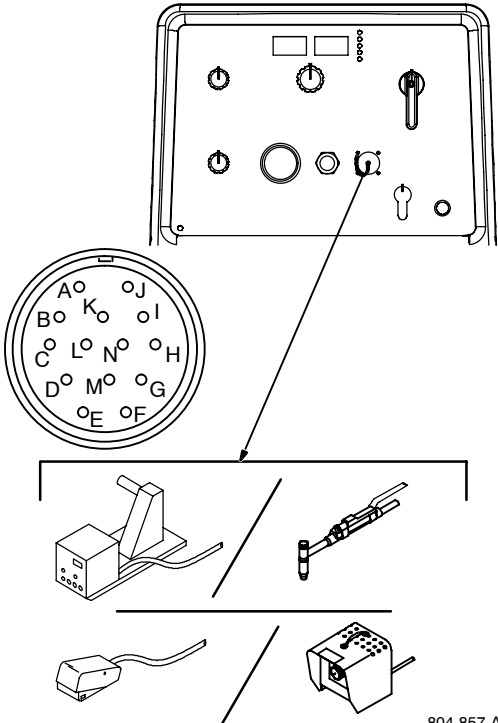
5-11. Remote Receptacle Information

	REMOTE 14	Socket*	Socket Information	
		24 VOLTS AC OUTPUT (CONTACTOR)	A	24 volts AC. Protected by supplementary protector CB4.
			B	Contact closure to A completes 24 volt AC contactor control circuit and keeps engine at Run speed in all modes.
		115 VOLTS AC OUTPUT (CONTACTOR)	I	115 volts AC. Protected by supplementary protector CB3.
			J	Contact closure to I completes 115 volts AC contactor control circuit.
	REMOTE OUTPUT CONTROL	C	+10 volts DC output to remote control.	
		D	Remote control circuit common.	
		E	0 to +10 volts DC input command signal from remote control.	
	A/V AMPERAGE VOLTAGE	F	Current feedback: 1 volt per 100 amperes.	
		H	Voltage feedback: 1 volt per 10 arc volts.	
GND	G	Circuit common for 24 and 115 volts AC circuits.		
	K	Chassis common.		
REMOTE COMPRESSOR ON/OFF	L	Remote compressor on/off (select compressor output on front panel). Grounding pin L stops compressor.		

804 857-A

*The remaining sockets are not used.

5-12. Connecting To The Air Compressor

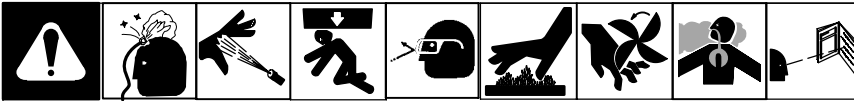

⚠ Stop engine and release air pressure before servicing compressor.

- 1 Air Compressor Outlet 1/2 in. NPT
- 2 Air Hose Routing Options

Use holes in the base and rear panel to route the air compressor hose (customer supplied) from the compressor outlet to the equipment.

 *Compressor outlet is shown with a quick-connect fitting (not supplied).*

Protect hose from rubbing on sheet metal base.

 *Obtain optional 50 ft (15 m) air hose with 1/2 in. NPT swivel fitting (Miller Part No. 300 571).*

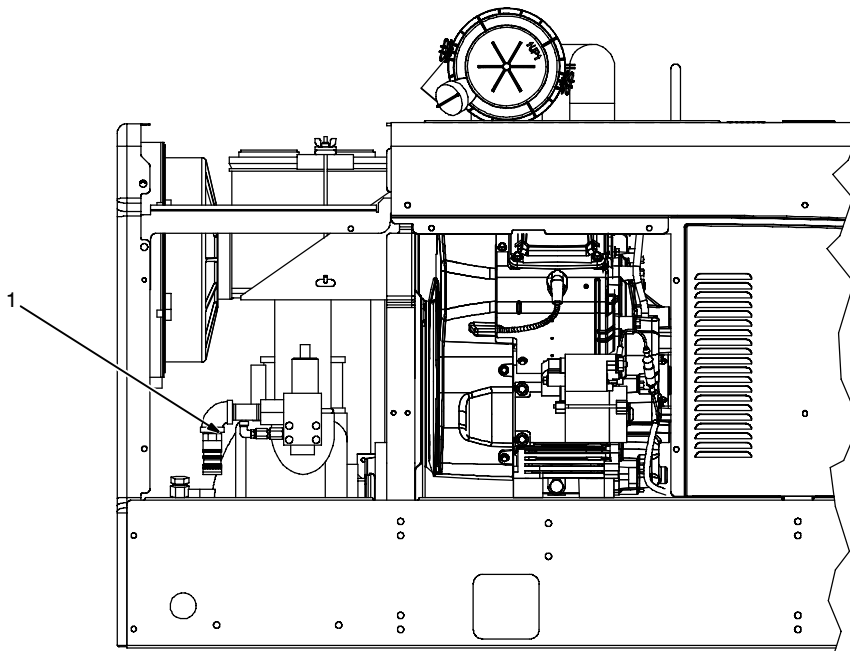

804 953-A / WM Design

SECTION 6 – OPERATING WELDING GENERATOR

6-1. Engine Controls

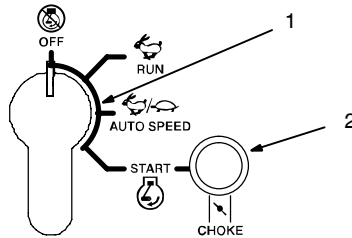
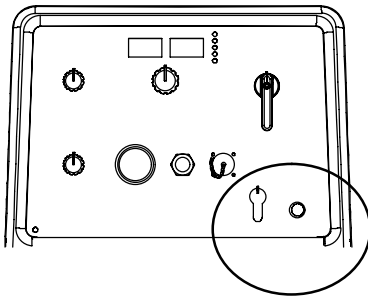

Ref. 804 857-B / Ref. 229 219-C

1 Engine Control Switch

Use switch to start engine, select speed, and stop engine. In Run position, engine runs at weld/power speed. In Auto/Speed position, engine speed responds to the work activity and load:

• Idle	2400 RPM
• Compressor	2400 RPM
• Small Stick/TIG Welding Loads Up To 165 A	3000 RPM
• Compressor	3000 RPM
• MIG/Heavy Stick Welding Loads	3600 RPM
• Compressor	3600 RPM
• Generator Power	3600 RPM

To view engine speed: with engine running and Process Selector switch in any Stick Hot position, cycle switch from Auto Speed to Run three times. Meters will display engine speed ± 16 RPMs. Turn machine off to reset display.

Use switch to reset engine and compressor oil change hours. See section 7-1.

⚠ The unit will not return to idle speed when the remote contactor is on and Process/Contactor switch is in any Wire position. The unit will return to idle speed in all other modes.

2 Engine Choke Control

Use control to change engine air-fuel mix when starting engine.

To Start: Pull out choke and turn Engine Control switch to Start position. Release switch and slowly push choke in when engine starts.

⚠ If the engine does not start, let the engine come to a complete stop before attempting restart.

⚠ During cold weather some gasoline engines encounter difficulties that are easily remedied. See Section 6-2 and 11-4.

To Stop: Turn Engine Control switch to Off position.

6-2. Cold Weather Engine Operation

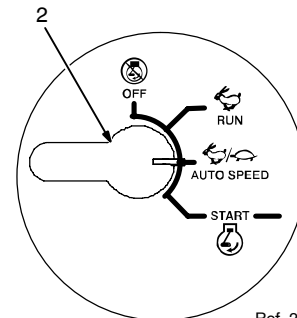
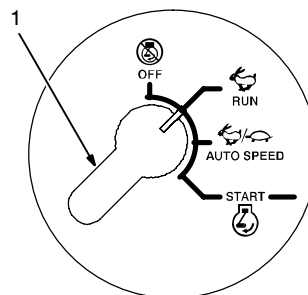

Ref. 229 219-A

1 Engine Control Switch Position For Infrequently Loaded Unit

2 Engine Control Switch Position For Frequently Loaded Unit

Carburetor Icing

Carburetor icing causes the unit to drop below the normal idle speed and then stall. This condition occurs when the temperature is near freezing and the relative humidity is high. Ice forms on the throttle plate and inner bore of the carburetor. The engine typically restarts without problems but soon stalls again.

- Treat gasoline with a fuel de-icer product (isopropyl alcohol).
- Place the Engine Control switch in the Run position.
- Run engine only when expecting to frequently load it.

Breather Icing

Oil breather/pulse line icing occurs in severe cold (continuously below 0°F). Moisture accumulates in the oil from piston ring blow-by if the engine is extensively idled. This may cause vacuum line freezing, oil breather tube freezing or ice in the carburetor. All of these cause operating problems. Due to ice in the lines, the engine may not restart until it is warmed to above freezing.

- Load engine and reduce idle times to prevent engine shutdowns.
- Use an electric fuel pump to avoid pulse line freezing.
- Install engine cold-weather kit.

Kohler (1-800-544-2444) offers kit for cold weather operation. The user can install kit. Kit pulls heated air from the muffler surface

into the carburetor and shuts the cold air off. This increases engine temperature during operation in both idle and high speed.

⚠ When the ambient temperatures become warmer (above 45°F) the air flow will have to be returned to normal.

Synthetic Oil

For temperatures below zero, synthetic oil improves engine starting. After the 50 hour break-in period, the engine oil can be switched between synthetic and non-synthetic type oils.

⚠ Do not extend the 100 hour recommended oil change interval.

In severe cold, use synthetic grades 5W20 or 5W30. See engine maintenance label for additional information.

6-3. Voltage/Amperage Control

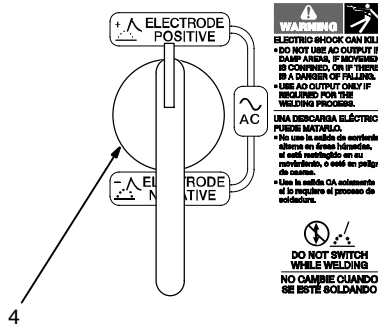
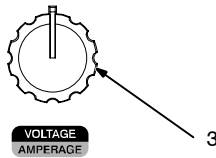
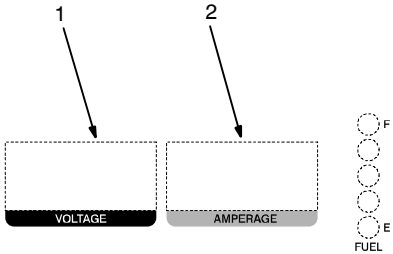
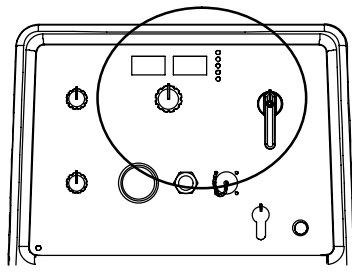

1 And 2 Displays

Displays show weld process information (voltage and amperage) and maintenance information (hourmeter, oil change countdown, or RPM).

Meter Weld Functions: In Wire modes, Voltmeter displays preset weld voltage when not welding. Meters display actual voltage and amperage when welding and for five seconds after welding has stopped.

In Stick and TIG modes, Voltmeter reads ON and Ammeter displays preset amperage when not welding. Meters display actual voltage and amperage when welding and for five seconds after welding has stopped.

See Section 11-1 for additional display code information.

3 Voltage/Amperage Control

Use control to select weld voltage or amperage. Control may be adjusted while welding.

With Process/Contactor switch in any Stick or TIG setting, use control to adjust amperage. With Process/Contactor switch in any Wire position, use control to adjust voltage. When a remote voltage/amperage control is connected to Remote receptacle RC4, control sets the maximum amperage in Stick and TIG modes, but has no effect in MIG modes.

4 Polarity/AC Switch

NOTICE – Do not switch while welding.

Use switch to select DC Electrode Negative or DC Electrode Positive weld output; or AC weld output.

Ref. 804 857-B / Ref. 229 219-C

6-4. Process/Contactor Switch

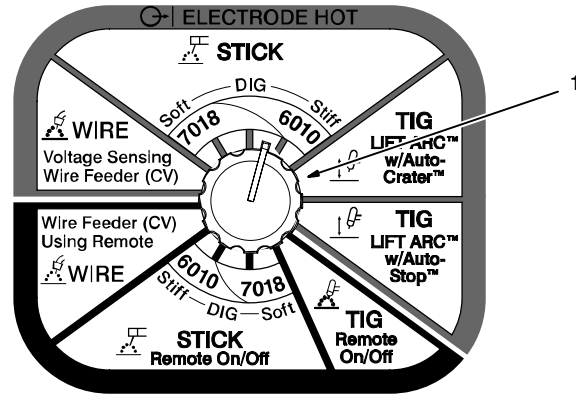
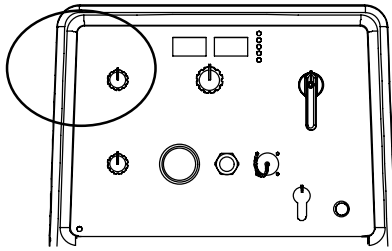

Ref. 804 857-B / Ref. 229 219-C

1 Process/Contactor Switch

⚠ Weld output terminals are energized when Process/Contactor switch is in an Electrode Hot position and the engine is running.

☞ The unit will not return to idle speed when Process/Contactor switch is in a Wire position and the remote contactor is on (closure between pins A and B on remote receptacle).

Use switch to select weld process and weld output on/off control (see table below and Section 5-11).

Place switch in Remote positions to turn weld output on and off with a device connected to the remote receptacle.

Place switch in Electrode Hot positions for weld output to be on whenever the engine is running.

Wire Positions:

Use Wire positions for MIG welding using a voltage sensing wire feeder (Electrode Hot) or wire feeder using remote control.

Stick Positions:

Use Stick positions for stick (SMAW) and air carbon arc (CAC-A) cutting and gouging.

Stick Electrode Hot:

When switch is in a Stick Electrode Hot mode, select one of four dig settings to provide additional amperage during short arc length conditions and help prevent electrodes from “sticking”. See Stick position descriptions following (reading L to R):

Soft Arc (E 7018) - This setting provides a low dig/arc force setting for smooth weld performance. A stable weld puddle with little arc “snap”, and reduces the potential for electrode sticking at shorter arc lengths.

Medium Soft Arc - This setting provides a low to medium dig/arc force that gives a slightly more fluid weld puddle, more arc “snap”, and reduces the potential for electrode sticking at shorter arc lengths.

Medium Stiff Arc - This setting provides medium dig/arc force for open root vertical up joints or joints that do not require additional current for fit up inconsistencies.

Stiff Arc (E6010) - This setting provides a high dig/arc force for open root vertical down joints where additional current is needed to compensate for tight joint fit-up without the need to increase overall welding current. This setting is recommended for those who prefer a very stiff arc with 6010 electrodes.

☞ Engine runs at 3600 RPM when welding with the Process/Contactor switch in the Stiff Arc (6010) position.

Stick Remote On/Off:

When switch is in a Stick Remote On/Off mode, select one of three settings to provide additional amperage during short arc length conditions and help prevent electrodes from “sticking”. See Stick position descriptions following (reading R to L):

Soft Arc (E7018) - This setting provides a low to medium dig/arc force that gives a slightly more fluid weld puddle, more arc “snap”, and reduces the potential for electrode sticking at shorter arc lengths.

Medium Arc - This setting provides medium dig/arc force for open root vertical up joints or joints that do not require additional current for fit up inconsistencies.

Stiff Arc (E6010) - This setting provides a high dig/arc force for open root vertical down joints where additional current is needed to compensate for tight joint fit up without the need to increase overall welding current. This setting is recommended for those who prefer a very stiff arc with 6010 electrodes.

The dig circuit is disabled when switch is in Wire or TIG positions.

TIG Positions:

TIG – Remote On/Off – Use this position for AC or DC TIG welding using remote on/off control.

Electrode Hot – Lift-Arc™ w/Auto Crater™ TIG (DC only) - With switch in this position, a low voltage (10 V DC) is present between the electrode and workpiece preventing overheating, sticking, or contamination of the electrode (see Section 6-6) as the arc is struck.

End the arc using the Auto-Crater feature (see Section 6-6).

Electrode Hot – Lift-Arc™ w/Auto Stop™ TIG (DC only) - With switch in this position, a low voltage (10 V DC) is present between the electrode and workpiece preventing overheating, sticking, or contamination of the electrode (see Section 6-6) as the arc is struck.

End the arc using the Auto-Stop feature (see Section 6-6).

Process/Contactor Switch Settings		
Switch Setting	Process	Output On/Off Control
Electrode Hot – Wire	MIG (GMAW)	Electrode Hot
Electrode Hot – Stick	Stick (SMAW) Select Preferred Dig	Electrode Hot
Electrode Hot – Stick	Air Carbon Arc (CAC-A) Cutting And Gouging Select Any Dig	Electrode Hot
Electrode Hot – Lift Arc w/Auto-Crater	TIG (GTAW) Lift Arc w/Auto-Crater (GTAW) (DC Only)	Electrode Hot
Electrode Hot – Lift Arc w/Auto-Stop	TIG (GTAW) Lift Arc w/Auto-Stop (GTAW) (DC Only)	Electrode Hot
TIG – Remote On/Off	GTAW With HF Unit, Pulsing Device, Or Remote Control (AC or DC)	At Remote Receptacle
Stick – Remote On/Off	Stick (SMAW) With Remote On/Off	At Remote Receptacle
Wire – Wire Feeder (CV) Using Remote	MIG (GMAW)	At Remote Receptacle

6-5. Stick Scratch Start

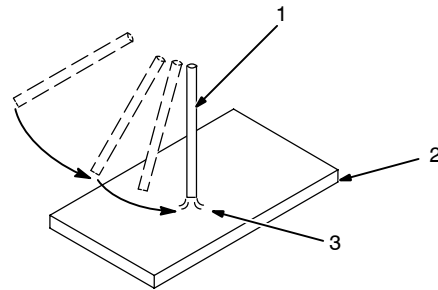

With Stick selected, start arc as follows:

- 1 Electrode
- 2 Workpiece
- 3 Arc

Drag electrode across workpiece like striking a match; lift electrode slightly after touching work. If arc goes out electrode was lifted to high. If electrode sticks to workpiece, use a quick twist to free it.

6-6. Lift-Arc™ TIG With Auto-Crater™ And Auto-Stop™



Arc Start With Lift-Arc

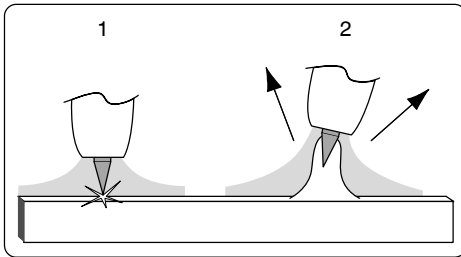

Arc End With Auto-Crater

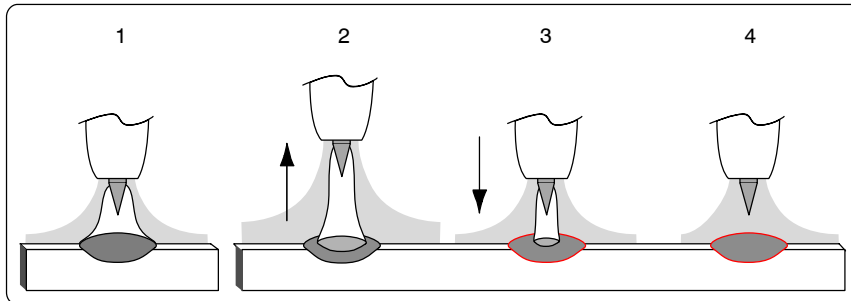

OR

Arc End With Auto-Stop

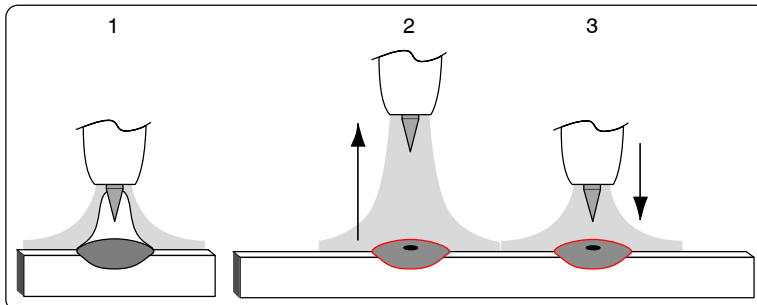

Arc Start With Lift-Arc TIG

Lift-Arc is used for the DCEN GTAW process when HF Start method is not permitted.

Select Lift-Arc at Process/Contact switch.

Turn gas on.

1 Touch or scratch.

2 Lift at any angle.

Touch tungsten electrode to workpiece at weld start point. Slowly lift electrode. Arc is started when electrode is lifted.

Maintain shielding gas coverage and eliminate tungsten and workpiece contamination by using Auto-Crater or Auto-Stop to end the arc.

Arc End With Auto-Crater:

 Remote control is not needed when using Auto-Crater.

1 While welding.

2 Lift torch slightly to start Auto-Crater end (current is reduced).

3 Lower torch. Weld current ramps down.

4 Shielding gas continues until shut off.

Arc End With Auto-Stop:

1 While welding.

2 Lift torch to start Auto-Stop. (Lift higher than that needed to start Auto-Crater.) Arc stops.

3 Move torch back down to maintain gas coverage and prevent contamination.

WM Marketing

6-7. Remote Voltage/Amperage Control

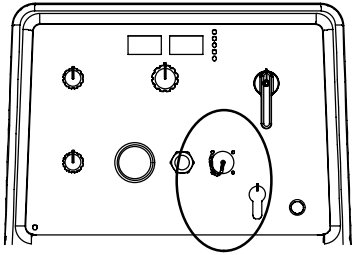

 **REMOTE**

1

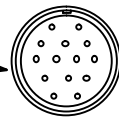

1 Remote Receptacle RC4

Connect optional remote voltage/amperage (V/A) control to RC4 (see Section 5-11).

Use receptacle to connect remote control or wire feeder.

When a remote voltage/amperage control is connected to the Remote receptacle, the Auto Sense Remote feature automatically switches voltage/amperage control to the remote control (see Sections 5-11 and 6-3).

With remote voltage/amperage control connected, weld output in CC mode is determined by a combination of front panel and remote control voltage/amperage settings. In CV mode, weld output is controlled through remote control only.

If no remote voltage/amperage control is connected to the Remote receptacle, the front panel Voltage/Amperage control adjusts voltage and amperage.

2 Remote Hand Control (Optional)

3 Remote Foot Control (Optional)

 *Engine runs at weld/power speed in Wire mode whenever a device connected to the remote receptacle makes closure between pins A and B. In all other modes, the engine runs at idle speed until a load is applied.*

In Example:
Process = Stick (Using Remote On/Off)
Min = 25 A CC/DC
Max = 160 A CC/DC

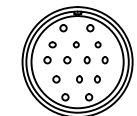

 **REMOTE**

Connect Remote V/A Control To Remote Receptacle RC4

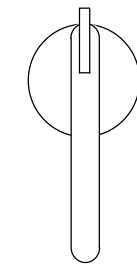

Select DC Output And Polarity

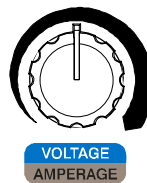

Set V/A Control (Mid-Range: About 160 A)

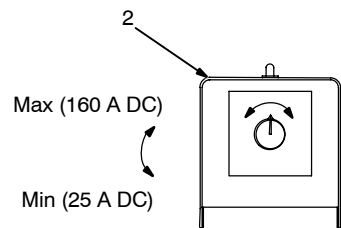

Adjust Remote V/A Control (Stick Welding Only)

3

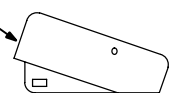

SECTION 7 – COMPRESSOR OPERATION

7-1. Air Compressor Switch

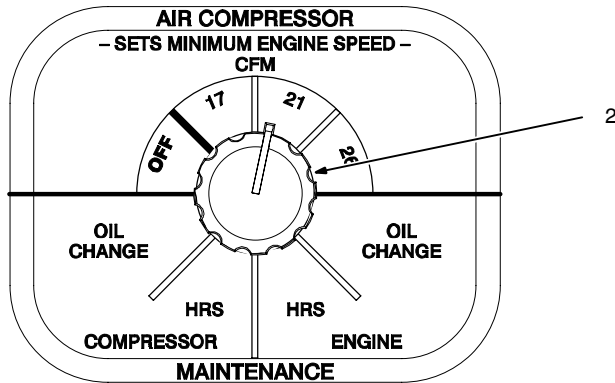
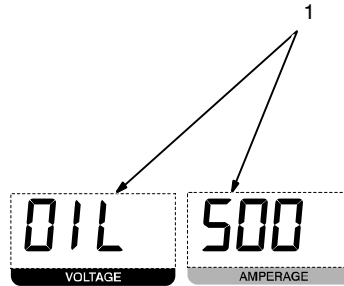
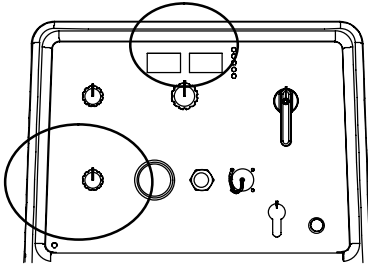
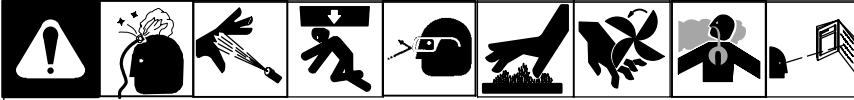

☞ Weld output and generator power are reduced when the air compressor is on.

With the compressor on, weld or generator loads will cause the engine to run at 3600 RPM.

Air Compressor Operation

1 Displays

Displays show air compressor status (on/off), and maintenance information (hours, oil change countdown, fault shutdown).

☞ See Section 11-1 for additional display code information.

2 Compressor Function Switch

Turn switch to Air Compressor CFM settings to turn compressor on. Turn switch to Off position to turn air compressor off.

At 17 CFM, engine runs at 2400 RPM.

At 21 CFM, engine runs at 3000 RPM.

At 26 CFM, engine runs at 3600 RPM.

Use 26 CFM setting for maximum air output.

☞ Weld output and generator power are reduced when the air compressor is on.

With the compressor on, weld or generator loads will cause the engine to run at 3600 RPM.

☞ To reduce moisture in the compressor air, install optional air cooler with separator (Part No. 300 420), or desiccant dryer (Part No. 195 117).

☞ When the temperature inside the unit drops below 45° (7°C), internal heaters activate to prevent air system freeze-up.

Air Compressor Maintenance

Use switch to monitor engine and compressor maintenance requirements.

Engine Hrs position displays total engine hours.

Engine Oil Change position displays hours left before next oil change. Hours count down from 100.

Compressor Hrs position displays total compressor hours.

Compressor Oil Change position displays hours left before next oil change. Hours count down from 500.

☞ Negative hours indicate time past recommended oil change.

To reset oil change hours: with engine off, place switch in Engine or Compressor Oil Change position and cycle Engine Control switch between Auto/Run and Run three times.

7-2. Air Compressor Gauge And Regulator

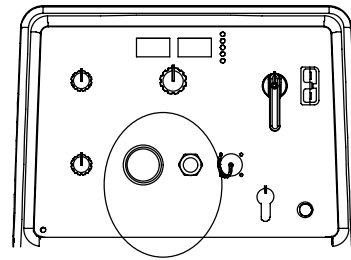
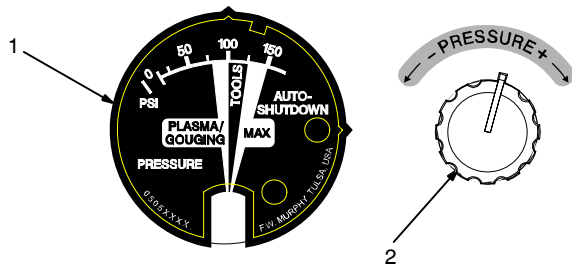
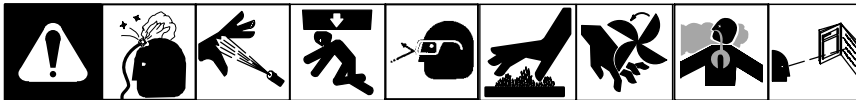

Ref. 804 857-A / Ref. 229 219-A / 229 807-B

⚠ The air pressure gauge reads the air compressor line pressure. Air pressure in the compressor case may be high even when the gauge reads zero. Wait 10 minutes for compressor blow down cycle to complete before checking/adding oil or performing maintenance.

☞ Weld output and generator power are reduced when the air compressor is on. With the compressor on, weld or generator loads will cause the engine to run at 3600 RPM.

- 1 Air Compressor Gauge
- 2 Air Pressure Regulator

Adjust system pressure with the regulator. Set pressure in the no-flow condition only. To reduce engine load and allow higher weld and generator output, set at lowest possible pressure for the job.

☞ Set pressure in the 80 – 100 psi (552 – 689 kPa) range to operate plasma cutting equipment or to gouge (CAC-A). Set pressure in the 100 – 125 psi (689 – 862 kPa) range to operate pneumatic tools.

☞ Do not set pressure above 150 psi (1034 kPa). If air pressure exceeds 150 psi the compressor clutch will disengage and shut down the compressor. Do not set pressure below 80 psi (552 kPa). Compressor will supply 80 psi regardless of setting below 80 psi.

See Section 7-3 for air compressor overload information.

7-3. Air Compressor Overload Protection

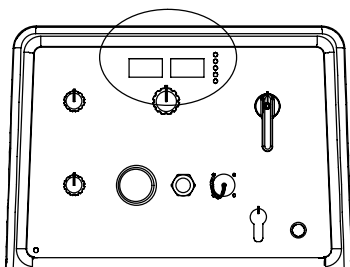
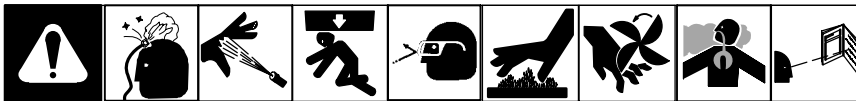

☞ See Section 9-5 for engine/generator overload protection.

Over Pressure Protection

☞ Do not set air pressure above 150 psi (1034 kPa). If air pressure exceeds 150 psi the compressor clutch will disengage and shut down the compressor.

If the compressor shuts down due to high pressure, use the Air Pressure regulator to reduce the system pressure. See Section 7-2.

The compressor is equipped with an emergency relief valve that will open if pressure approaches 200 psi (1379 kPa).

Over Temperature Protection

☞ The compressor is equipped with high oil temperature shutdown. High oil temperature can be caused by low oil, hot air recirculation, blocked or clogged cooler, or fan failure.

☞ When the temperature inside the unit drops below 45° (7° C), internal heaters activate to prevent air system freeze-up. Ice in air system components may cause an Over Pressure condition.

Ref. 804 857-A / Ref. 229 219-A

7-4. Compressor Blow Down

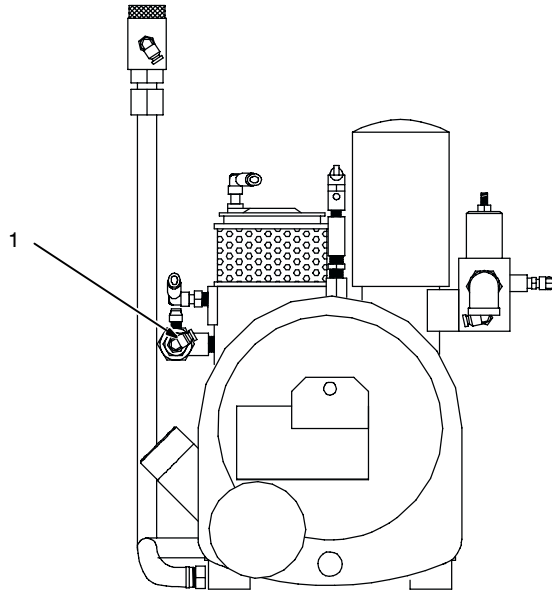
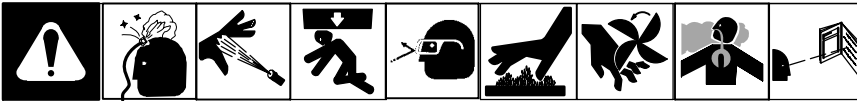

1 Blow Down Valve

To prevent foaming or sudden release of pressure, allow 10 minutes after shutdown before opening the compressor oil dipstick/fill cap or performing other compressor maintenance.

To control the release of air mixed in the compressor oil (while running), the compressor goes through a blow down cycle when the compressor is turned off or the engine is stopped. The blow down valve slowly discharges the pressure in the compressor.

236 200

Notes

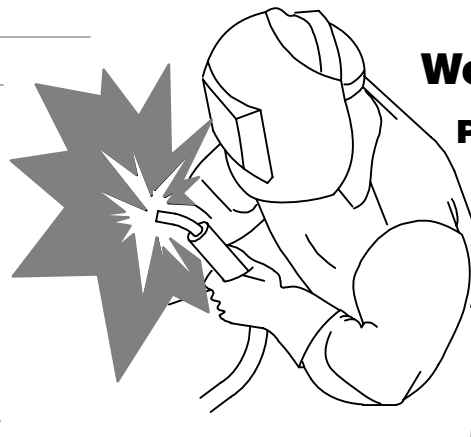

Work like a Pro!

Pros weld and cut safely. Read the safety rules at the beginning of this manual.

SECTION 8 – OPERATING AUXILIARY EQUIPMENT

8-1. Generator Power Receptacles And Supplementary Protectors



⚠ If unit does not have GFCI receptacles, use GFCI-protected extension cord.

ℹ Generator power decreases as weld current or air compressor output increases.

- 240 V 50 A AC Receptacle RC1
- 120 V 20 A AC Duplex Receptacle RC2
- 120 V 20 A AC Duplex Receptacle RC3

RC1 supplies 60 Hz single-phase power at weld/power speed. Maximum output is 11 kVA/kW.

- Supplementary Protector CB1
- Supplementary Protector CB2
- Supplementary Protector CB3

CB1 protects receptacles RC1, RC2, RC3, and 115 volt AC output to Remote Receptacle RC4 from overload. If CB1 opens, the receptacles do not work and 115 volt AC output to Remote Receptacle RC4 stops. Place switch in On position to reset.

CB2 protects RC2 from overload. CB3 protects RC3 and the 115 volt AC output to Remote Receptacle RC4 from overload. If CB2 opens, RC2 does not work. If CB3 opens, RC3 does not work and the 115 volt AC output to RC4 stops. Press button to reset.

ℹ If supplementary protector continues to open, contact Factory Authorized Service Agent.

Combined output of all receptacles limited to 10 kVA/kW rating of the generator.

EXAMPLE: If 20 A is drawn from each 120 V duplex receptacle, only 20 A is available at the 240 V receptacle:

$$2 \times (120 \text{ V} \times 20 \text{ A}) + (240 \text{ V} \times 25 \text{ A}) = 9.6 \text{ kVA/kW}$$

Ref. 229 219

8-2. Optional GFCI Receptacles



⚠ If unit does not have GFCI receptacles, use GFCI-protected extension cord.

ℹ Generator power decreases as weld current or compressor output increases.

Combined output of all receptacles limited to 10 kVA/kW rating of the generator.

GFCI Receptacle Option

- 120 V 20 A AC GFCI Receptacles GFCI-2 and GFCI-3

GFCI2 and GFCI3 supply 60 Hz single-phase power at weld/power speed. Maximum output from GFCI-2 or GFCI-3 is 2.4 kVA/kW. Circuit protection is the same as standard receptacles.

If a ground fault is detected, the GFCI Reset button pops out and the circuit opens to disconnect the faulty equipment. Check for damaged tools, cords, plugs, etc. connected to the receptacle. Press button to reset receptacle and resume operation.

ℹ At least once a month, run engine at weld/power speed and press Test button to verify GFCI is working properly.



Ref. 229 219

8-3. Simultaneous Weld And Power

 This table shows simultaneous weld and power output with air compressor off.

Weld Current in Amperes	Total Power in Watts	120 V Receptacle Amperes	240 V Receptacle Amperes
300	1000	10	5
250	3500	31	15
200	5200	46	23
150	6700	60	30
100	8000	70	35
0	11,000	88	44

8-4. Wiring Instructions For Optional 240 Volt, Single-Phase Plug (NEMA 14-50P)



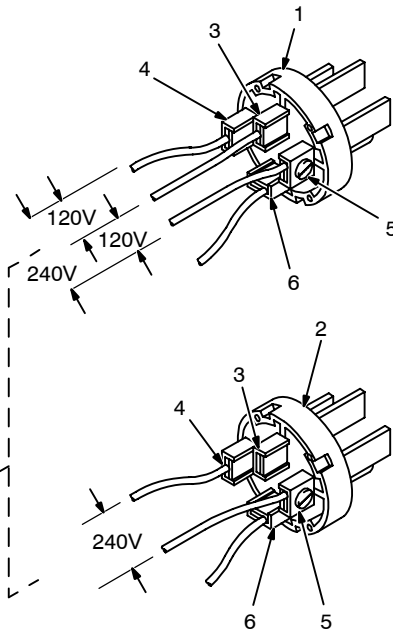



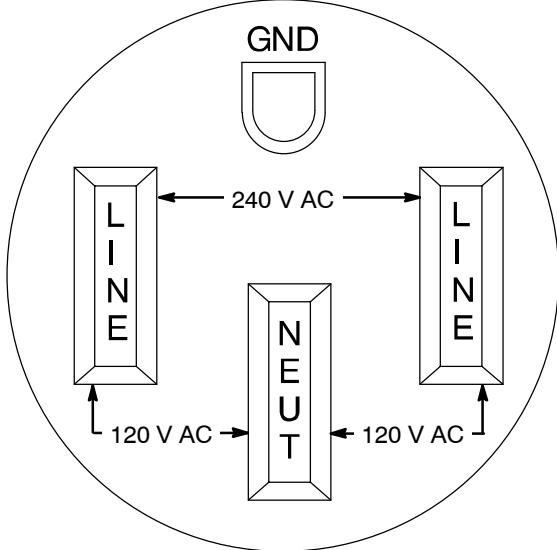

The plug can be wired for a 240 V, 2-wire load or a 120/240V, 3-wire load. See circuit diagram.

- 1 Plug Wired for 120/240 V, 3-Wire Load
- 2 Plug Wired for 240 V, 2-Wire Load
- 3 Neutral (Silver) Terminal
- 4 Load 1 (Brass) Terminal
- 5 Load 2 (Brass) Terminal
- 6 Ground (Green) Terminal
- 7 Amperes Available using 120/240 V Plug

When wired for 120 V loads, each duplex receptacle shares a load with one half of 240 V receptacle.

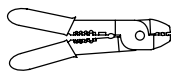

Tools Needed:

Current Available in Amperes	
240 V Receptacle*	Each 120 V Duplex Receptacle
0	20
5	20
10	20
15	20
20	20
25	15
30	10
35	5
40	0

V x A = Watts

*One 240 V load or two 120 V loads.

plug1 11/03 - 120 813-D

SECTION 9 – GENERATOR/ENGINE MAINTENANCE

9-1. Maintenance Label

KOHLER CH750 GAS ENGINE

See Engine Manual for complete engine care. Give Engine Specification and Serial Number when ordering parts.



Check Daily



To Drain Oil:
Push And Turn CCW

Recommended Oil
API Service Classification SG or higher

Oil Change 100 hours
Oil Filter Change 200 hours
Oil Filter MILLER 066 698, Kohler 1205001
Oil Capacity w/filter change Approximately 1.5 quarts

DO NOT OVERFILL Keep oil level between L & F marks on dipstick.

NO SOBRELLENE Mantenga el nivel del aceite entre las marcas L y F del medidor.

Fuel Grade Unleaded, 87 Octane min.
10% Ethanol or less
Fuel Filter MILLER 215 984, Kohler 2505022

Gasoline 

12 Volt Battery BCI Group 61R
Cranking Performance at 0°F (-18°C) 450 Amps min.

Air Filter Service 250 hours – see Owner's Manual
Air Filter MILLER 288 744, Kohler 2508801
Air Filter (Safety Element) MILLER 288 745, Kohler 2508804

Engine Speed
No Load  High Speed 3600 RPM
Mid 3000 RPM
Idle 2400 RPM
Engine speeds are not adjustable.

METER MAINTENANCE FUNCTIONS

- **ENGINE HOURS:** displays engine hours.
- **ENGINE OIL CHANGE:** displays hours left before next oil change. Hours count down from 100.

NOTE: Negative hours indicate time past recommended change.

RESET: With engine off and switch at Engine Oil Change, cycle Engine Control Switch between AUTO SPEED and RUN 3 times.
- **ENGINE RPM's:** With engine running and the Process Selector switch in any Stick HOT position, cycle Engine Control switch from the AUTO SPEED to RUN position 3 times and meters will display Engine RPM's. Accuracy is ±16 RPM's. Turn machine off to reset display.

FUNCIONES DE MANTENIMIENTO DE LOS MEDIDORES

- **La pantalla de horas de funcionamiento:** muestra las horas de marcha del motor.
- **La pantalla de cambio de aceite del motor:** muestra las horas que faltan para el próximo cambio de aceite. Esta cuenta regresiva arranca en 100 horas.

NOTA: las horas con signo negativo indican el tiempo en que se ha sobrepasado el cambio de aceite.

Rearme (puesta a cero): cambie 3 veces el interruptor de control del motor de la posición "AUTO SPEED" a la "RUN" y viceversa (con el motor apagado y el interruptor en la posición de cambio de aceite [Engine Oil Change]).
- **RPMs DEL MOTOR:** Con el motor funcionando y el interruptor de controlar el proceso en cualesquiera posición "Stick HOT", cicle el control del motor de la posición AUTO SPEED a RUN 3 veces y los medidores mostrarán el RPM DEL MOTOR. La precisión es ±16 RPMs. Apague la máquina para rearmar la pantalla.

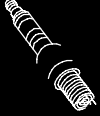

Spark Plug MILLER 288 746, Kohler 2413207,
Champion 3071
Gap: 0.028 in.

Tune-up and Filter Kit . . . (Includes Air, Oil and Fuel Filters, and 2 Spark Plugs)
MILLER 288 748

289-314-G

OM-229 930 Page 41

9-2. Routine Generator/Engine Maintenance











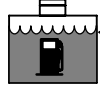

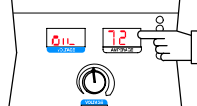

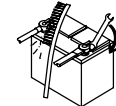
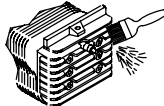

 Use information displayed on the Voltmeter/Ammeter displays to assist in scheduling maintenance (see Section 6-3).

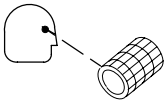
Engine speed is regulated by an electronic governor. Engine speed adjustments may only be performed by a Factory Authorized Service Agent.

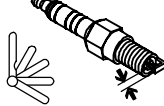
Follow the storage procedure in the engine owner's manual if the unit will not be used for an extended period.

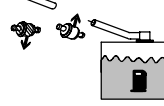
For Compressor Maintenance, see Section 10.

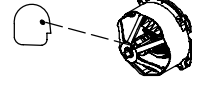
						 <p>Recycle engine fluids.</p>	 <p>Stop engine before maintaining.</p>
<p> See Engine Manual and Maintenance Label for important start-up, service, and storage information. Service engine more often if used in severe conditions.</p>							

		✓ = Check ◇ = Change ● = Clean ☆ = Replace * To be done by Factory Authorized Service Agent			Reference
Every 8 Hours	 ✓ Fuel Level	 ✓ Oil Level	 ✓ Meters for next oil change interval	 ● Oil, Fuel Spills	Sections 5-4, 6-3
Every 25 Hours	 ✓ ● Spark Arrestor Screen (If Equipped)				Sections 9-3, 9-6
Every 50 Hours	 ● Weld Terminals				
Every 100 Hours	 ● Battery Terminals	 ● Cooling System	 ◇ Oil	 ✓ ☆ Air Cleaner Element	Engine Manual, Sections 9-3, 9-4
Every 200 Hours	 ☆ Unreadable Labels	 ✓ Spark Plug Gap	 ◇ Oil Filter	 ☆ Fuel Filter	Engine Manual, Section 9-4
Every 500 Hours	 ✓ ☆ Weld Cables	 ✓ ● Slip Rings* ✓ ☆ Brushes*	 ✓ Valve Clearance*		Engine Manual
Every 1000 Hours	 ● Inside Unit				

9-3. Servicing Air Cleaner

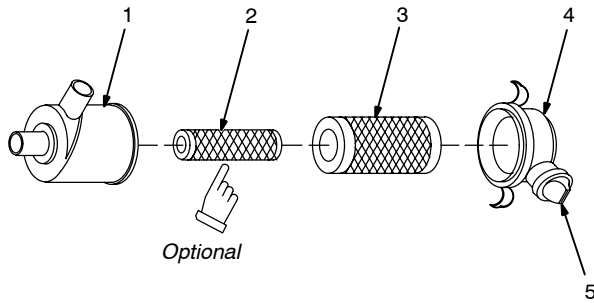
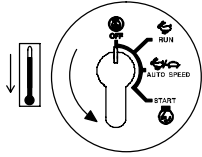

⚠ Stop engine.

⚠ Do not run engine without air cleaner or with dirty element. Engine damage caused by using a damaged element is not covered by the warranty.

☞ The air cleaner primary element can be cleaned but the dirt holding capacity of the filter is reduced with each cleaning. The chance of dirt reaching the clean side of the filter while cleaning and the possibility of filter damage makes cleaning a risk. Consider the risk of unwarrantable equipment damage when determining whether to clean or replace the primary element.

*If you decide to clean the primary element, we strongly recommend installing an optional safety element to provide additional engine protection. **Never clean a safety element.** Replace the safety element after servicing the primary element three times.*

Clean or replace primary element if dirty (see note above before cleaning). **Replace** primary element if damaged. Replace primary element yearly or after six cleanings.

- 1 Housing
- 2 Safety Element (Optional)
- 3 Primary Element
- 4 Dust Cap
- 5 Dust Ejector

To clean air filter:

Wipe off cap and housing. Remove cap and dump out dust. Remove element(s). Wipe dust from inside cap and housing with damp cloth. Reinstall safety element (if present). Reinstall cap.

⚠ Do not clean housing with air hose.

Clean primary element with compressed air only.

Air pressure must not exceed 100 psi (690 kPa). Use 1/8 in (3 mm) nozzle and keep nozzle at least 2 in (51 mm) from inside of element. Replace primary element if it has holes or damaged gaskets.

Reinstall primary element and cap (dust ejector down).

Keep nozzle
2 in (51 mm)
from element.

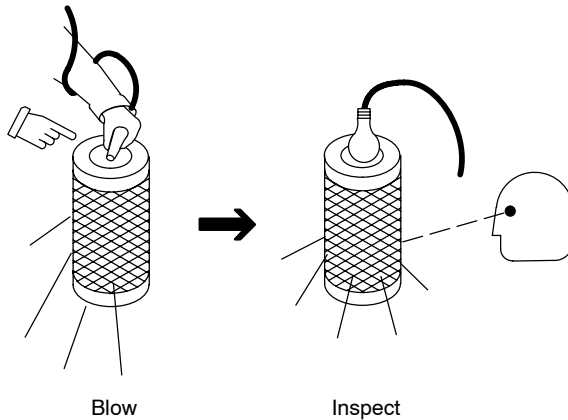

9-4. Changing Engine Oil, Oil Filter, And Fuel Filter

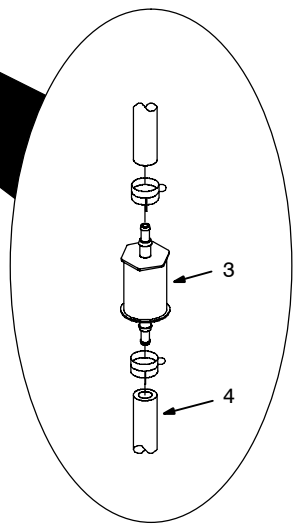
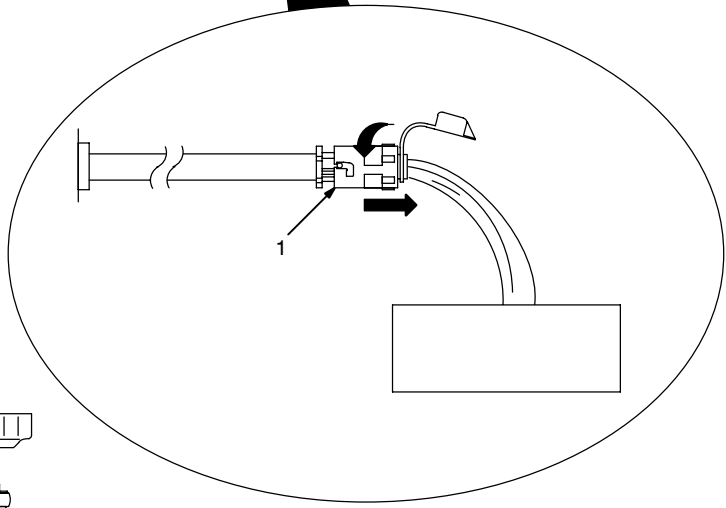
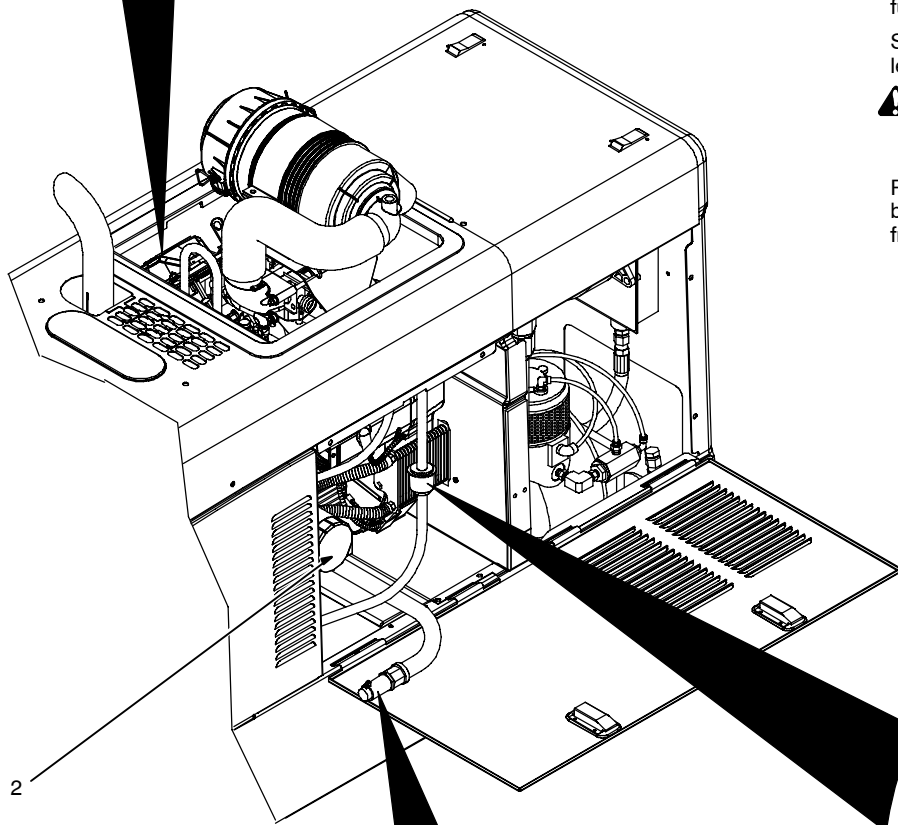
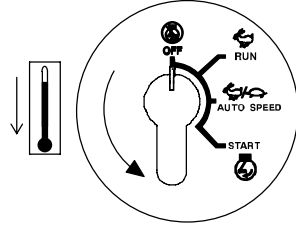
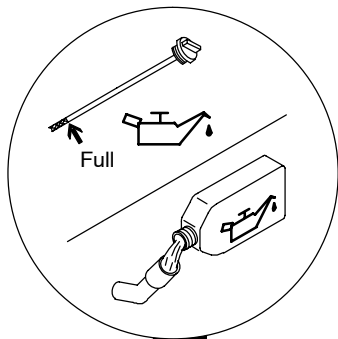

Tools Needed:

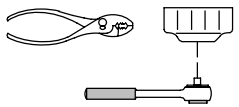

⚠ Stop engine and let cool.

- 1 Oil Drain Valve
- 2 Oil Filter

Change engine oil and filter according to engine manual.

⚠ Close valve and valve cap before adding oil and running engine.

Fill crankcase with new oil to full mark on dipstick (see Section 5-4).

- 3 Fuel Filter
- 4 Fuel Line

Replace line if cracked or worn. Install new filter. Wipe up any spilled fuel.

Start engine, and check for fuel leaks.

⚠ Stop engine, tighten connections as necessary, and wipe up fuel.

Reset oil maintenance countdown by flipping Engine Control switch from Run/Idle to Run three times.

9-5. Overload Protection

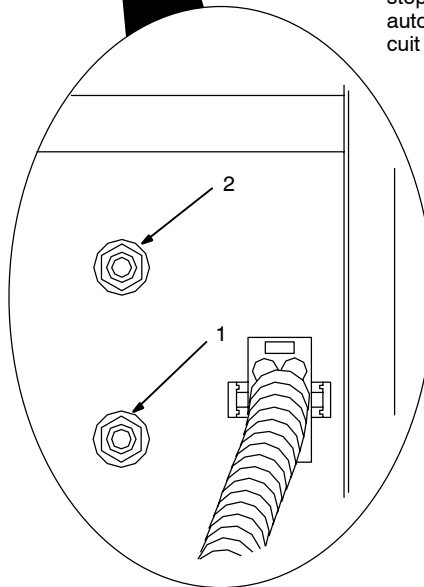
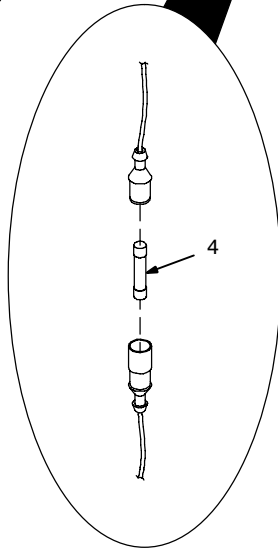
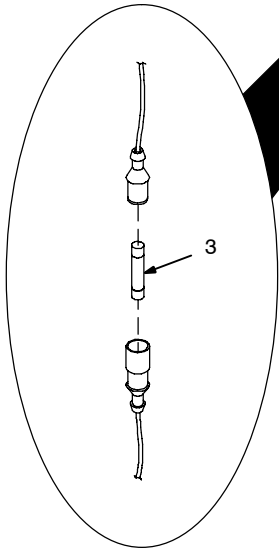
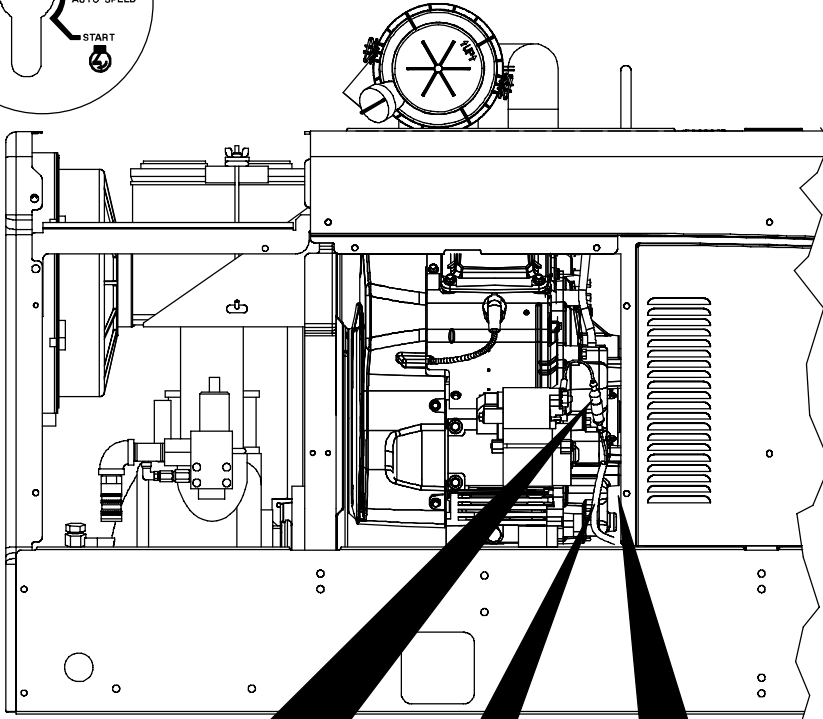
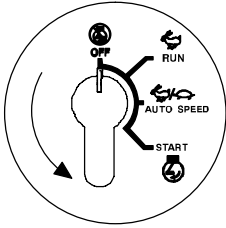

Stop engine.

Open left side door.

 When a circuit breaker, supplementary protector or fuse opens, it usually indicates a more serious problem exists. Contact a Factory Authorized Service Agent.

- 1 Supplementary Protector CB4
- 2 Supplementary Protector CB6

CB4 protects the stator winding supplying 24 volt AC output to Remote receptacle RC4. If CB4 opens, 24 volt AC output to RC4 stops.

CB6 protects the compressor air line heater. If CB6 opens, the compressor air lines may freeze in cold weather and cause a no air pressure or high air pressure condition.

 Supplementary protectors CB1 and CB3 protect the stator winding supplying 115 volt AC output to Remote Receptacle RC4 (see Section 8-1).

Press button to reset.

- 3 Fuse F6 (See Parts List)
- 4 Fuse F7 (See Parts List)

F6 and F7 protect the engine wiring system from overload. If F6 or F7 opens, the engine will not crank.

Replace fuse if open.

Close left side door.

- 5 Circuit Breaker CB5 (Not Shown)

CB5 protects the air compressor. If CB5 opens, the air compressor stops (the clutch and fan stop). CB5 automatically resets when the circuit breaker cools.

9-6. Servicing Optional Spark Arrestor

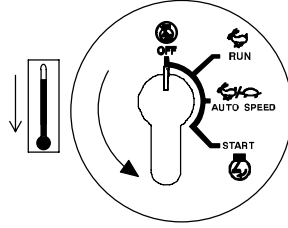
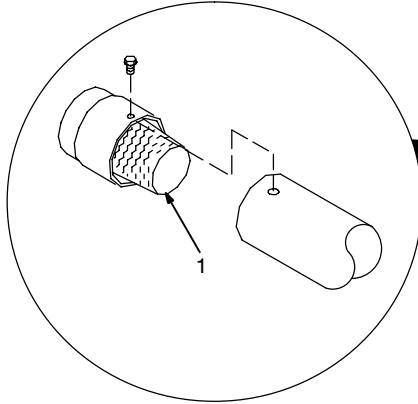
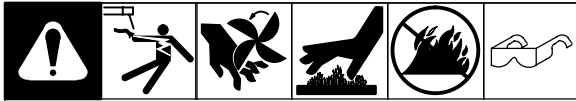

⚠ Stop engine and let cool.

1 Spark Arrester Screen

Clean and inspect screen. Replace spark arrester if screen wires are broken or missing.

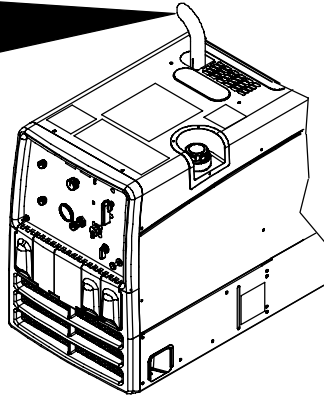

Tools Needed:

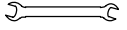
 1/4 in.



804 951 / Ref. 803 572-A

Notes

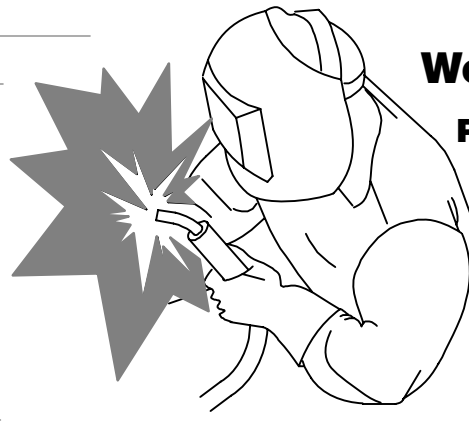



Work like a Pro!

Pros weld and cut safely. Read the safety rules at the beginning of this manual.

SECTION 10 – AIR COMPRESSOR MAINTENANCE

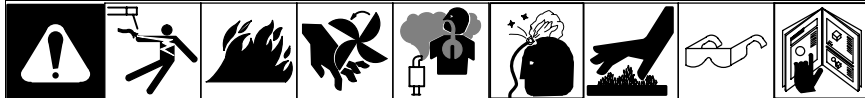



10-1. Maintenance





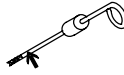
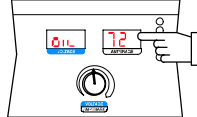

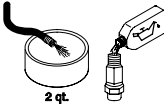
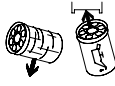
 Recycle engine fluids.
  **Stop engine before maintaining.**

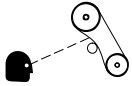
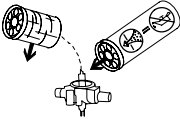
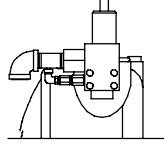
 See compressor Maintenance Label for important start-up and service information. Service compressor more often if used in severe conditions.

 Replace compressor oil and filter after the first 50 hours of operation.

🕒	✔ = Check * To be done by Factory Authorized Service Agent	◇ = Change	● = Clean	☆ = Replace	Reference
Every 8 Hours	 ✔ Oil Level.	To Check Oil Level: Do not open dipstick until unit has been off for 10 minutes. Do not open while running. Screw dipstick fully in before checking oil level.	 ✔ Meters for next oil change interval	 ● Fluid Spills	Sections 5-4, 7-1
Every 500 Hours Or Yearly	 ◇ Oil	 ☆ Oil Filter	 ☆ Air Cleaner	 ✔ Belt Condition/Tension	Section 10-3, 10-4
	 ☆ Air/Oil Separator	 ✔ Air & Control Lines For Wear & Aging			

10-2. Compressor Maintenance Label

<p>AIR COMPRESSOR</p>  <p>Oil Level:</p> <ul style="list-style-type: none"> Do not remove dipstick until unit has been off for 10 minutes. Do not remove while running. Screw in dipstick completely when checking level. Do not mix oil types. Use Mobil 1 Synthetic ATF only. Add 12 oz. when below lower hole. Do not overfill. <p>500 h / 1 yr std.</p> <p>NOTE: Replace oil and filter after first 50 hours; then every 500 hours or yearly.</p> <p>IMPORTANT: Use Mobil 1 Synthetic ATF Only</p> <p>Compressor Oil: MILLER: 232 207</p> <p>Compressor Oil Filter: MILLER: 232 208 (Replace Air Cleaner more often when operating in dirty conditions.)</p> <p>Compressor Air/Oil Separator: MILLER: 232 209</p> <p>Compressor Filter/Separator Kit: MILLER: 235 202 (Includes oil filter, air filter, and separator)</p> <p>Belt: MILLER: 229 913 (Replace if damaged or loose.)</p>	<p>WARNING</p>  <p>ROTATING PARTS can cause injury or death.</p> <ul style="list-style-type: none"> Keep body parts and clothing well clear of belt and fan.  <p>BREATHING COMPRESSED AIR can cause serious injury or death.</p> <ul style="list-style-type: none"> Do not use compressed air for breathing. Use only for cutting, gouging, and tool.  <p>COMPRESSED AIR can cause injury.</p> <ul style="list-style-type: none"> Wear approved safety goggles. Do not direct air stream toward self or others.  <p>HOT METAL from air arc cutting and gouging can cause fire or explosion.</p> <ul style="list-style-type: none"> Do not cut or gouge near flammables. Watch for fire; keep extinguisher nearby. 	<p>¡Precaución!</p> <p>Las PIEZAS GIRATORIAS pueden causar lesiones o la muerte.</p> <ul style="list-style-type: none"> Mantenga su cuerpo, miembros y ropa bien alejados de la correa y del ventilador. <p>NO RESPIRE EL AIRE COMPRIMIDO pues podría causarle graves lesiones o la muerte.</p> <ul style="list-style-type: none"> No utilice aire comprimido para respirar. Utilícelo únicamente para las operaciones de corte, ranurado y acortamiento de herramientas. <p>EL AIRE COMPRIMIDO puede causar lesiones.</p> <ul style="list-style-type: none"> Use gafas de seguridad aprobadas. No dirija el chorro de aire comprimido hacia usted u otras personas. <p>EL METAL CALIENTE producido por el corte y el ranurado por arco con aire puede provocar incendios o explosiones.</p> <ul style="list-style-type: none"> No efectúe operaciones de corte o ranurado cerca de elementos inflamables. Vigile que no se produzcan incendios; tenga siempre a mano un extinguidor.
<p>Trapped Air Pressure and Whipping Hoses can cause injury.</p> <ul style="list-style-type: none"> Release air pressure from tools and system before servicing, adding oil, changing elements, or opening oil drain or oil fill cap. Wait 10 minutes after system pressure is zero before opening. <p>Hot Parts can cause burns and injury.</p> <ul style="list-style-type: none"> Do not touch hot compressor or air system parts. Let system cool down before touching or servicing. <p>Read Owner's Manual before using or servicing unit.</p> <ul style="list-style-type: none"> Stop engine and release air pressure before servicing. 	<p>EL AIRE CONTENIDO EN EL SISTEMA, LA PRESIÓN Y UNA MANGUERA AZOTANDO EL LUGAR DE TRABAJO pueden causar lesiones.</p> <ul style="list-style-type: none"> Antes de realizar tareas de mantenimiento, agregar o cambiar accesorios, abrir drenaje o la tapa de llenado de aceite, asegure la presión de aire en las herramientas y en el sistema. Antes de abrir espere 10 minutos hasta que no haya presión en el sistema. <p>Las PIEZAS CALIENTES pueden causar quemaduras y lesiones.</p> <ul style="list-style-type: none"> No toque las piezas calientes del compresor o del sistema de aire. Deje que el sistema se enfríe antes de realizar tareas de mantenimiento o tocar partes del mismo. <p>Antes de realizar tareas de mantenimiento o utilizar la unidad, lea el Manual del usuario.</p> <ul style="list-style-type: none"> Antes de realizar tareas de mantenimiento, pare el motor y descargue el aire comprimido. 	<p>EL AIRE CONTENIDO EN EL SISTEMA, LA PRESIÓN Y UNA MANGUERA AZOTANDO EL LUGAR DE TRABAJO pueden causar lesiones.</p> <ul style="list-style-type: none"> Antes de realizar tareas de mantenimiento, agregar o cambiar accesorios, abrir drenaje o la tapa de llenado de aceite, asegure la presión de aire en las herramientas y en el sistema. Antes de abrir espere 10 minutos hasta que no haya presión en el sistema. <p>Las PIEZAS CALIENTES pueden causar quemaduras y lesiones.</p> <ul style="list-style-type: none"> No toque las piezas calientes del compresor o del sistema de aire. Deje que el sistema se enfríe antes de realizar tareas de mantenimiento o tocar partes del mismo. <p>Antes de realizar tareas de mantenimiento o utilizar la unidad, lea el Manual del usuario.</p> <ul style="list-style-type: none"> Antes de realizar tareas de mantenimiento, pare el motor y descargue el aire comprimido.
<p>FRONT PANEL SWITCH – MAINTENANCE</p> <p>Compressor Hours – displays compressor hours.</p> <p>Compressor Oil Change – displays hours left before next oil change. Hours count down from 500.</p> <p>NOTE: Negative hours indicate time past recommended change. Reset: With engine off and switch at Compressor Oil Change, cycle Engine Control Switch between AUTO SPEED and RUN 3 times.</p>	<p>PRESSURE SETTING</p> <ul style="list-style-type: none"> Use front panel regulator to set pressure. Do not set above 150 psi. Automatic shutdown will occur. Pressure safety valve may open. Compressor takes engine power even if air isn't flowing. Turn off when not in use. Higher pressures require more engine power. Use lowest pressure required for the process. Lower pressure means more available weld and generator power. 	<p>PRESSURE SETTING</p> <ul style="list-style-type: none"> Use front panel regulator to set pressure. Do not set above 150 psi. Automatic shutdown will occur. Pressure safety valve may open. Compressor takes engine power even if air isn't flowing. Turn off when not in use. Higher pressures require more engine power. Use lowest pressure required for the process. Lower pressure means more available weld and generator power.

282 114-C

10-3. Servicing Compressor Air Cleaner And Air/Oil Separator

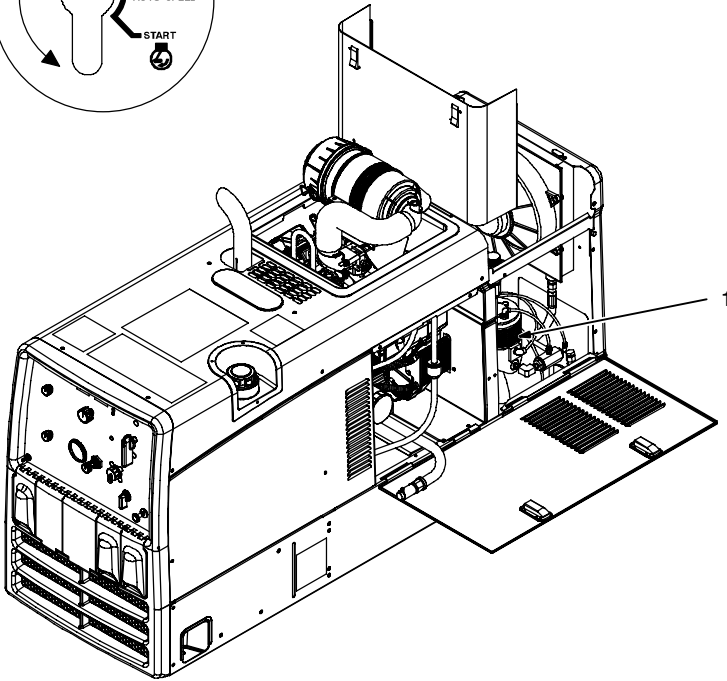
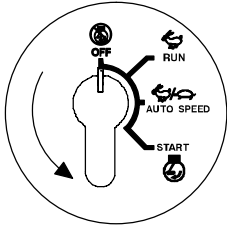
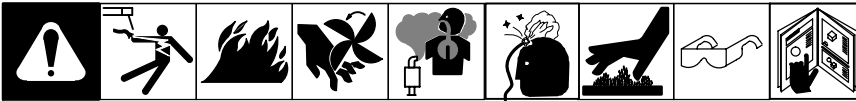

⚠ Stop engine.

⚠ Wait 10 minutes for compressor blow down cycle to complete before performing maintenance.

NOTICE – Do not run air compressor without air cleaner or with dirty element. Compressor damage caused by using a damaged element is not covered by the warranty.

- 1 Compressor Air Cleaner
- 2 Cover
- 3 Air Cleaner Element

Wipe off cover. Remove cover and element. Wipe dust from cover and housing with damp cloth. Inspect element and install new element if necessary. Reinstall cover.

NOTICE – Do not clean element with compressed air.

- 4 Air/Oil Separator

To replace air/oil separator:

Turn filter counterclockwise. Remove filter.

Apply thin coat of oil to gasket on new filter. Install filter and turn clockwise.

Start engine, run air compressor, and check for oil leaks.

⚠ Stop engine.

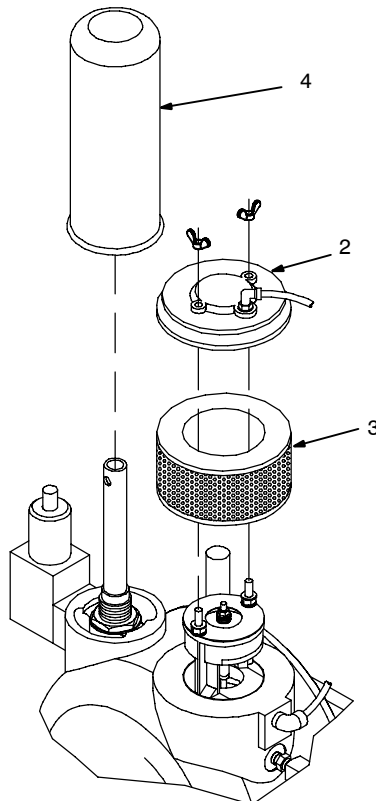

Tools Needed:

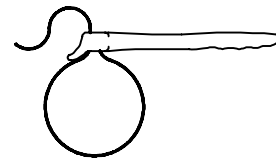

10-4. Changing Air Compressor Oil And Filter

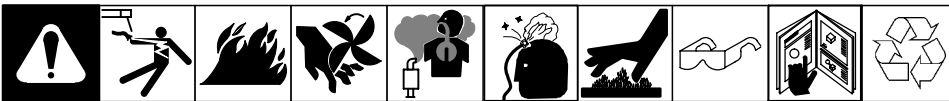

Tools Needed:

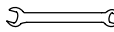
 7/8, 15/16 in

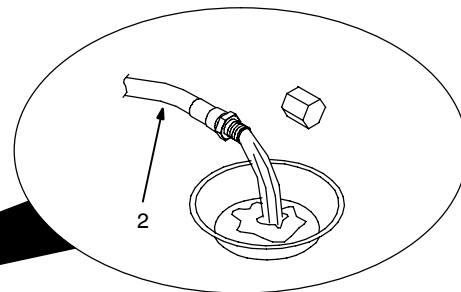
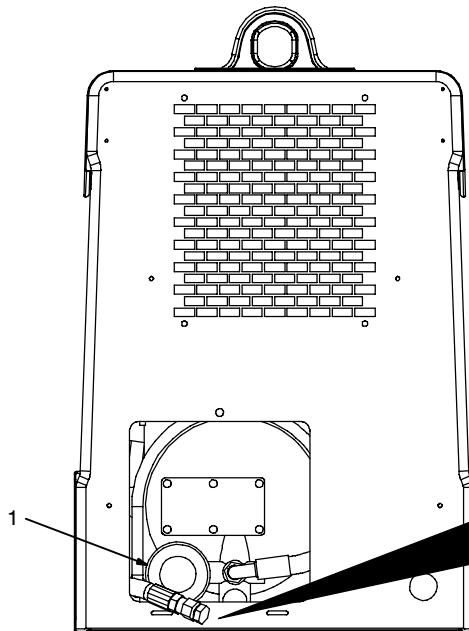
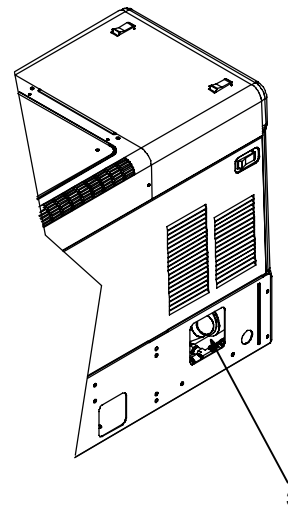
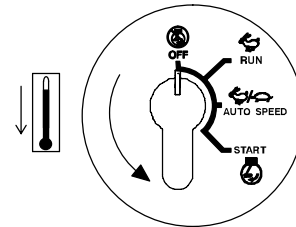
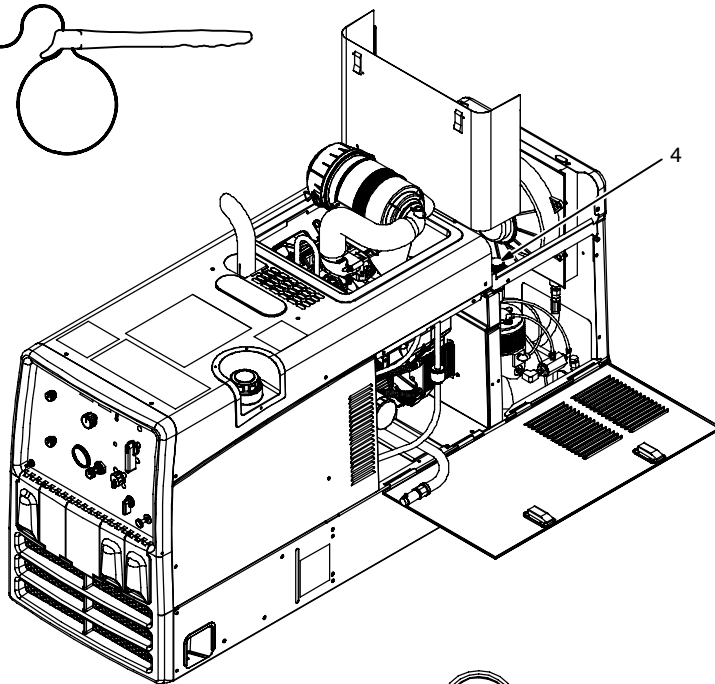
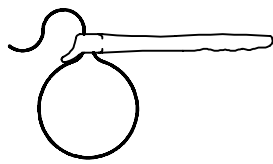

804 950-A / 804 951-A / 804 952-A

 **Stop engine and let cool.**

 **Wait 10 minutes for compressor blow down cycle to complete before performing maintenance.**

- 1 Air Compressor Oil Filter
- 2 Air Compressor Oil Drain Hose
- 3 Air Compressor Oil Fill Cap

4 Air Compressor Oil Dipstick/Fill

To change compressor oil and filter:

Drain compressor oil while compressor is still warm.

Route compressor oil drain hose through access panel on rear panel. Remove compressor oil dipstick/fill cap. Remove plug from oil drain hose and drain oil into a suitable container. Reinstall oil drain hose plug.

Remove filter by turning filter counterclockwise. Apply thin coat of oil to gasket on new filter. Install new filter and turn clockwise until tight.

Add recommended oil until oil level on dipstick shows system is full (see compressor maintenance label for oil specifications). Reinstall oil fill cap. Hand-tighten cap to prevent pressure release.

SECTION 11 – TROUBLESHOOTING

11-1. Front Panel Display Code Information

Left Display	Right Display	Description	How/When Code Is Displayed
ON	25 – 304	Preset Weld Current	Code is displayed when engine is running, Engine Control switch is in Run or Auto Speed position, Process/Contactor switch is in Electrode Hot – Stick or TIG position, and Compressor switch is in Off or On positions.
0	25 – 304	Preset Weld Current	Code is displayed when engine is running, Engine Control switch is in Run or Auto Speed position, Process/Contactor switch is in Remote – Stick or TIG position, and Compressor switch is in Off or On positions.
13 – 35	0	Preset Weld Voltage	Code is displayed when engine is running, Engine Control switch is in Run or Auto Speed position, Process/Contactor switch is in Electrode Hot – Wire or Remote – Wire position, and Compressor switch is in Off or On positions.
HRS	XXXX	Engine Or Compressor Total Operating Hours	Code is displayed when Engine Control switch is in Run or Auto Speed position and Compressor switch is in Engine Hours or Compressor Hours position. (Engine need not be running to display code.)
OIL	XXX	Hours Remaining Until Recommended Oil Change For Engine Or Compressor	Code is displayed when Engine Control switch is in Run or Auto Speed position and Compressor switch is in Engine Oil Change or Compressor Oil Change position. (Engine need not be running to display code.) Display shows negative hours when oil change is overdue.
RPM	XXXX	Engine Speed	Code is displayed when engine is running, Process/Contactor switch is in Electrode Hot – Stick position, and Engine Control switch is toggled between Run and Auto Speed positions three or four times.
AIR	OFF	Air Compressor Off	Before start-up, code is displayed when Engine Control switch is in Run or Auto Speed position and Compressor switch is in Off position. Code is also displayed for three seconds when Compressor switch is moved to Off position while engine is running. (Display then returns to appropriate weld display.)
AIR	ON	Air Compressor On	Before start-up, code is displayed when Engine Control switch is in Run or Auto Speed position and Compressor switch is in any On position. Code is also displayed for three seconds when Compressor switch is moved to any On position while engine is running. (Display then returns to appropriate weld display.)
COMP	TEMP	Compressor Over-Temperature	Code is displayed when compressor has stopped because compressor oil temperature exceeded 240° F (116° C).
OVER	PRES	Compressor Over-Pressure	Code is displayed when compressor has stopped because compressor air pressure exceeded 170 PSI (1172 kPa).
AUTO	CAL.	Auto-Calibration	Code is displayed for about six seconds after start-up as the electronic governor calibrates itself by running the engine at an elevated speed for a short period. The machine provides no output until the display changes.
RE-S	TART	Restart	Code is displayed when unit has stopped due to generator overload or detection of a fault that could cause damage. Turn Engine Control switch Off and then restart. Check all outputs and connections after restarting. If code is displayed again have unit checked by an Authorized Service Agent.
All Segments On	All Segments On	Bulb Test	During engine cranking all LED segments are turned on for test purposes. Observe the displays during cranking to determine if an indicator is faulty.

11-2. Welding Troubleshooting

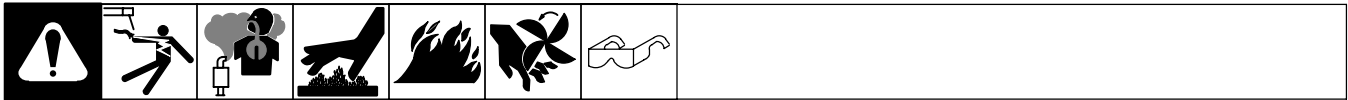

Trouble	Remedy
No weld output.	<p>Check weld control settings.</p> <p>Check weld connections.</p> <p>Disconnect equipment from generator power receptacles during start-up.</p> <p>Increase front panel and/or remote voltage/amperage control settings (see Sections 6-3 and 6-7).</p> <p>Check and secure connections to Remote receptacle RC4 (see Sections 5-11).</p> <p>Have Factory Authorized Service Agent check brushes, slip rings, and circuit boards PC1 and PC2.</p>
Low weld output.	<p>Check control settings.</p> <p>Increase front panel and/or remote voltage/amperage control settings (see Sections 6-3 and 6-7).</p> <p>Check and clean air cleaner as necessary (see Section 9-3).</p> <p>Have Factory Authorized Service Agent check engine speed, brushes, slip rings, and circuit boards PC1 and PC2.</p> <p>See engine manual.</p>
High weld output.	<p>Check control settings.</p> <p>Have Factory Authorized Service Agent check engine speed and circuit boards PC1 and PC2.</p>
Weld output cannot be adjusted.	<p>Have Factory Authorized Service Agent check field current control board PC2.</p>
Erratic weld output.	<p>Check control settings.</p> <p>Clean and tighten connections both inside and outside unit.</p> <p>Check and secure lead connections to remote control.</p> <p>Be sure connection to work piece is clean and tight.</p> <p>Remove excessive coils from weld cables.</p> <p>Use dry, properly stored electrodes.</p> <p>Have Factory Authorized Service Agent check engine speed, brushes, slip rings, and circuit boards PC1 and PC2.</p> <p>Check shielding gas, ensure proper shielding gas coverage while welding.</p>
No remote voltage/amperage control.	<p>Check and tighten connections to Remote receptacle RC4 (see Section 5-11). Check and secure lead connections to remote control.</p>
No front panel voltage/amperage control.	<p>Disconnect remote control from Remote receptacle RC4 if not needed for weld process (see Section 5-11).</p>
No 24 volt AC power output at Remote receptacle RC4.	<p>Reset supplementary protector CB4 (see Section 9-5).</p>
No 115 volt AC power output at Remote receptacle RC4.	<p>Reset supplementary protector(s) CB1 and/or CB3 (see Section 8-1).</p>
Lack of high frequency; difficulty in establishing Gas Tungsten Arc Welding arc.	<p>Use proper size tungsten for welding amperage.</p> <p>Reduce leakage of high frequency from torch or work cable (check grounding, remove excessive coils from weld cables, use shorter weld cables, etc.).</p> <p>Check cables and torch for cracked or deteriorated insulation or bad connections. Repair or replace necessary parts.</p>
Wandering arc – poor control of arc direction.	<p>Reduce gas flow rate.</p> <p>Select proper size tungsten. Properly prepare tungsten.</p>

Trouble	Remedy
Tungsten electrode oxidizing and not remaining bright after conclusion of weld.	Shield weld zone from drafts.
	Increase postflow time.
	Check and tighten all gas fittings.
	Properly prepare tungsten.

11-3. Generator Power Troubleshooting

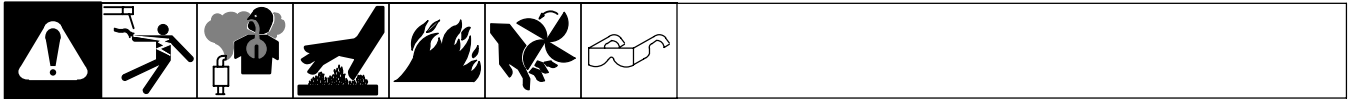

Trouble	Remedy
No power output.	Reset supplementary protectors CB1, CB2 and/or CB3 (see Section 8-1).
	Have Factory Authorized Service Agent check brushes, slip rings, and circuit boards PC1 and PC2.
Low power output.	Check and clean air cleaner as necessary.
	Have Factory Authorized Service Agent check engine speed.
	See engine manual.
High power output.	Have Factory Authorized Service Agent check engine speed.
Erratic power output.	Have Factory Authorized Service Agent check engine speed, brushes, slip rings, and field current control board PC2.
	Check receptacle wiring and connections.

11-4. Engine Troubleshooting

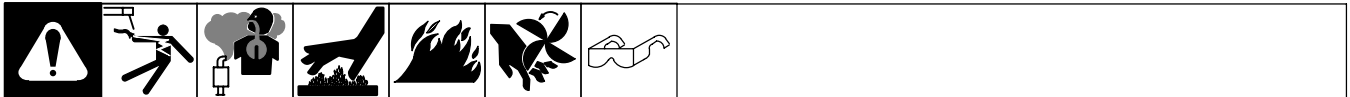

Trouble	Remedy
Engine will not crank.	Check fuses F6 and F7, and replace if open (see Section 9-5).
	Check battery voltage.
	Check battery connections and tighten if necessary.
	Check plug PLG5 and plug PLG8 connections.
	Have Factory Authorized Service Agent check Engine Control switch S2.
Engine does not start.	Check fuel level (see Section 5-4).
	Check battery and replace if necessary.
	Check engine charging system according to engine manual.
	Have Factory Authorized Service Agent check fuel shutoff solenoid FS1 according to engine manual.
	See engine manual.
Engine starts but stops when Engine Control switch returns to Auto Speed position.	Check oil level (see Section 5-4). Low oil pressure shutdown stops engine if oil pressure is too low.
	Use correct grade oil for operating temperature. (see Section 9-1).
	Have Factory Authorized Service Agent check low oil pressure shutdown switch S5.

Trouble	Remedy
Battery discharges between uses.	Place Engine Control switch in Off position when unit is not running.
	Clean top of battery with baking soda and water solution; rinse with clear water.
	Periodically recharge battery (approximately every 3 months).
	Replace battery.
	Check voltage regulator according to engine manual.
Engine stopped during normal operation.	Check fuel level (see Section 5-4).
	Check oil level (see Section 5-4). Low oil pressure shutdown stops engine if oil pressure is too low. Oil level too high reduces capacity of the fuel pump.
	Have Factory Authorized Service Agent check fuel shutoff solenoid FS1 according to engine manual.
	Have Factory Authorized Service Agent check low oil pressure shutdown switch S5.
Engine does not return to idle speed.	Be sure Engine Control switch S2 is in Auto Speed position.
	Remove all weld and generator power loads.
	Place Process/Contactor switch in Electrode Hot position or turn off remote contactor. The unit will not return to idle speed when Process/Contactor switch is in a remote position and the remote contactor is on.
	Turn off remote device connected to Remote receptacle RC4 (see Section 5-11).
	Have Factory Authorized Service Agent check circuit board PC1 and current transformer CT1.
Engine does not remain at weld/power speed when power or weld load is applied with Engine Control switch in Auto Speed position.	Place Engine Control switch in the Run position for small loads.
During operation in near freezing temperatures, engine starts and goes to idle but stalls after a few minutes.	Treat fuel with isopropyl alcohol de-icer product.
	Place Engine Control switch in the Run position until unit has been in operation and loaded for a period of time.
During operation in severe cold weather, engine starts and goes to idle but stalls after a few minutes.	Install engine manufacturer's kit for cold-weather operation.

11-5. Compressor Troubleshooting

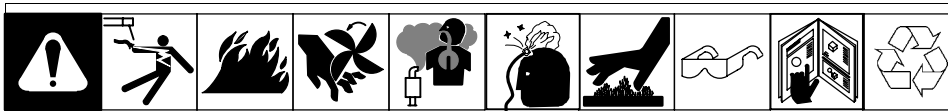

Trouble	Remedy
Air compressor does not operate; no air pressure on gauge.	Place Air Compressor switch in an On position. If compressor is turned off, wait for air pressure to bleed off before turning compressor on again.
	Reset supplementary protector CB5. (CB5 automatically resets when it cools.) If CB5 continues to open, contact Factory Authorized Service Agent.
	Check compressor belt and tension. Be sure correct belt is used and is properly installed. Replace belt if damaged or stretched.
	Have Factory Authorized Service Agent check Air Compressor control circuit and clutch.
Air compressor stops with air demand.	Check compressor oil level (see Section 5-4). Automatic shutdown stops compressor if compressor temperature is too high.
	Verify adequate air flow to compressor. Check for blocked air intake. Recirculation or open covers may cause overheating. Be sure all covers, panels, and doors are in place. Operate in area with proper airflow. Automatic shutdown stops compressor if compressor temperature is too high.
	Replace compressor oil filter (see Section 10-4).
	Have Factory Authorized Service Agent check compressor cooling fan and clean compressor cooler core. Automatic shutdown stops compressor if compressor temperature is too high.

Trouble	Remedy
Air compressor stops after short period of operation.	Check compressor oil level (see Section 5-5). Automatic shutdown stops compressor if compressor temperature is too high.
	Circuit breaker CB5 is open. CB5 automatically resets when the compressor cools. If CB5 continues to open, contact Factory Authorized Service Agent.
	Check fan operation. Fan should run whenever compressor is on. Have Factory Authorized Service Agent check fan circuit.
	Clean debris from oil cooler. Automatic shutdown stops compressor if compressor temperature is too high. Recirculation or open covers may cause overheating. Be sure all covers, panels, and doors are in place. Operate in area with proper airflow.
Low air pressure.	Check for leaks in air lines and hoses, including control line.
	Reduce air demand.
	Close air outlet valve.
	Adjust compressor air pressure (see Section 7-2).
	Check air compressor air cleaner (see Section 10-3).
	Check compressor belt and tension. Be sure correct belt is used and is properly installed. Replace belt if damaged or stretched.
	Have Factory Authorized Service Agent check compressor blow down valve, and for leaks in control lines. Also check air compressor for rated output.
High air pressure.	Adjust compressor air pressure (see Section 7-2).
	Verify control line is connected at regulator valve and inlet valve. Check for frozen control lines.
	Check air/oil separator, and replace if plugged (see Section 10-3).
	Have Factory Authorized Service Agent check for leaks in control lines, and also check air gauge, compressor air inlet valve, safety valve, air pressure switch, and internal heating system.
Insufficient air delivery.	Check air compressor air cleaner (see Section 10-3).
	Check air/oil separator, and replace if plugged (see Section 10-3).
	Check engine speed, and adjust if necessary.
	Check compressor belt and tension. Be sure correct belt is used and is properly installed. Replace belt if damaged or stretched.
	Have Factory Authorized Service Agent check compressor air inlet valve, safety valve, air pressure switch, and internal heating system.
Oil in air from compressor.	Check compressor oil level (see Section 5-5). If oil level is too high, system becomes saturated with oil.
	Change compressor air/oil separator if close to replacement hours (see Section 10-3).
	Check connections of control lines.
	Have Factory Authorized Service Agent check for plugged oil scavenge line.
Air compressor overheats.	Check compressor oil level (see Section 5-4). Automatic shutdown stops compressor if compressor temperature is too high.
	Verify adequate air flow to compressor. Check for blocked air intake. Recirculation or open covers may cause overheating. Be sure all covers, panels, and doors are in place. Operate in area with proper airflow. Automatic shutdown stops compressor if compressor temperature is too high.
	Adjust compressor air pressure (see Section 7-2).
	Replace compressor oil filter (see Section 10-4).
	Have Factory Authorized Service Agent check cooling fan. Automatic shutdown stops compressor if compressor temperature is too high.
	Have Factory Authorized Service Agent check thermal valve element, and replace if necessary.
	Have Factory Authorized Service Agent clean compressor cooler core.
Oil in compressor air cleaner.	Have Factory Authorized Service Agent verify compressor inlet valve is operating properly.
Water in compressor oil.	Operate air compressor to remove water.
Moisture in compressor air.	Install optional air cooler with separator (Part No. 300 420), or desiccant dryer (Part No. 195 117).
System retains pressure after shutdown.	Have Factory Authorized Service Agent check compressor blow down valve, and leak back from airline.

SECTION 12 – PARTS LIST

12-1. Recommended Spare Parts

Dia. Mkgs.	Part No.	Description	Quantity
Recommended Spare Parts			
..... F6	021718 ..	Fuse, Mintr GI 30 Amp 32 Volt	1
..... F7	073429 ..	Fuse, Mintr GI Slo-Blo 15 Amp 32 Volt	1
.....	238743 ..	Tune-up & Filter Kit, Kohler (Includes)	1
.....	238744 ..	Air Filter Element	1
.....	238745 ..	Air Filter, Kohler Safety Element	1
.....	066698 ..	Oil Filter	1
.....	215985 ..	Filter, Fuel w/Clamps & 1/4 in Fuel Line	1
.....	238746 ..	Spark Plug	2
.....	232207 ..	Filter, Oil Air Compressor	1
.....	232208 ..	Filter, Inlet Air Air Compressor	1
.....	232209 ..	Separator, Oil/Air Rotary Screw Compressor	1
.....	229913 ..	Belt, Drive	1

SECTION 13 – ELECTRICAL DIAGRAMS

⚠ WARNING

- Do not touch live electrical parts.
- Disconnect input power or stop engine before servicing.
- Do not operate with covers removed.
- Have only qualified persons install, use, or service this unit.

ELECTRIC SHOCK HAZARD

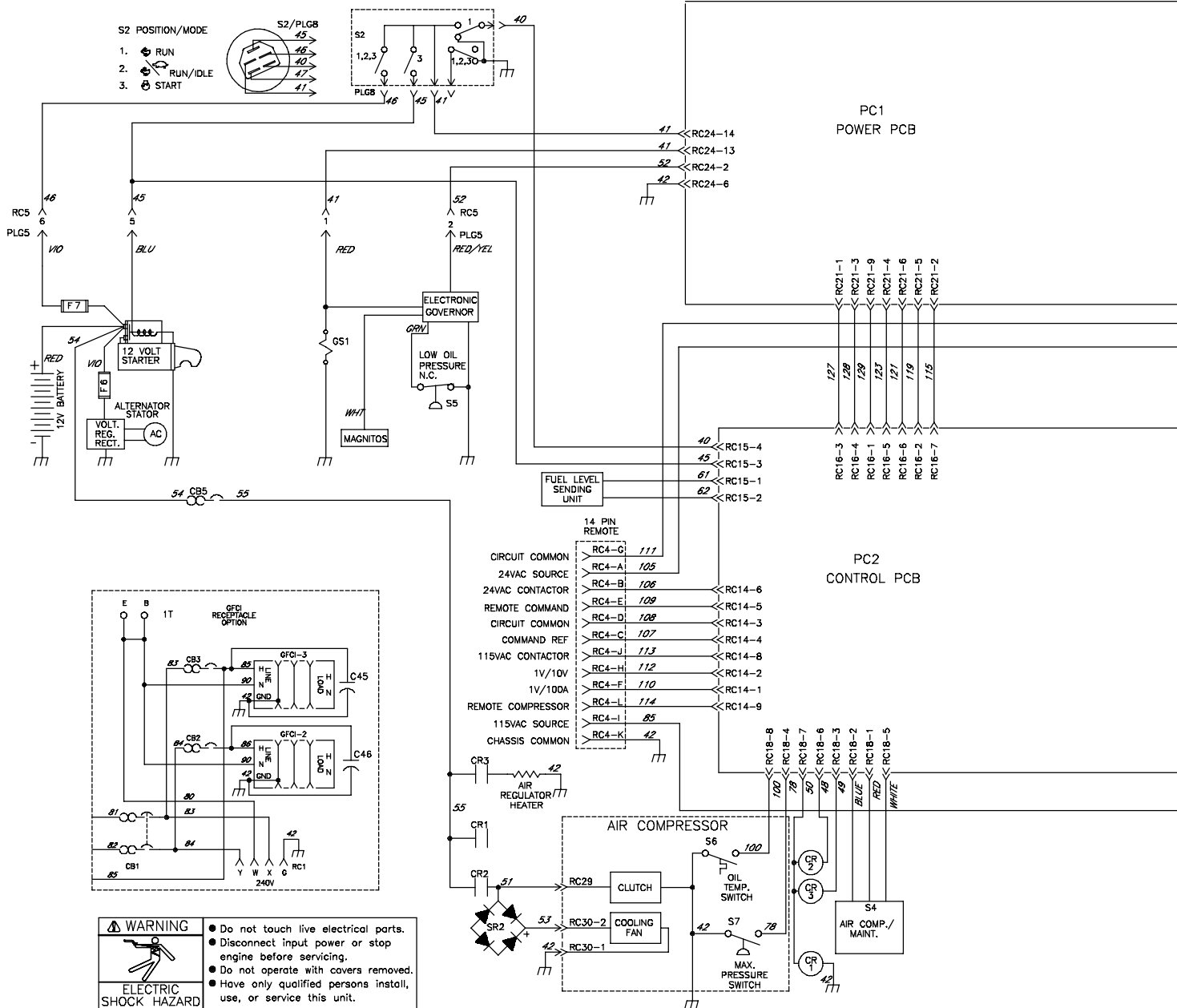

⚠ WARNING

- Do not touch live electrical parts.
- Disconnect input power or stop engine before servicing.
- Do not operate with covers removed.
- Have only qualified persons install, use, or service this unit.

ELECTRIC SHOCK HAZARD

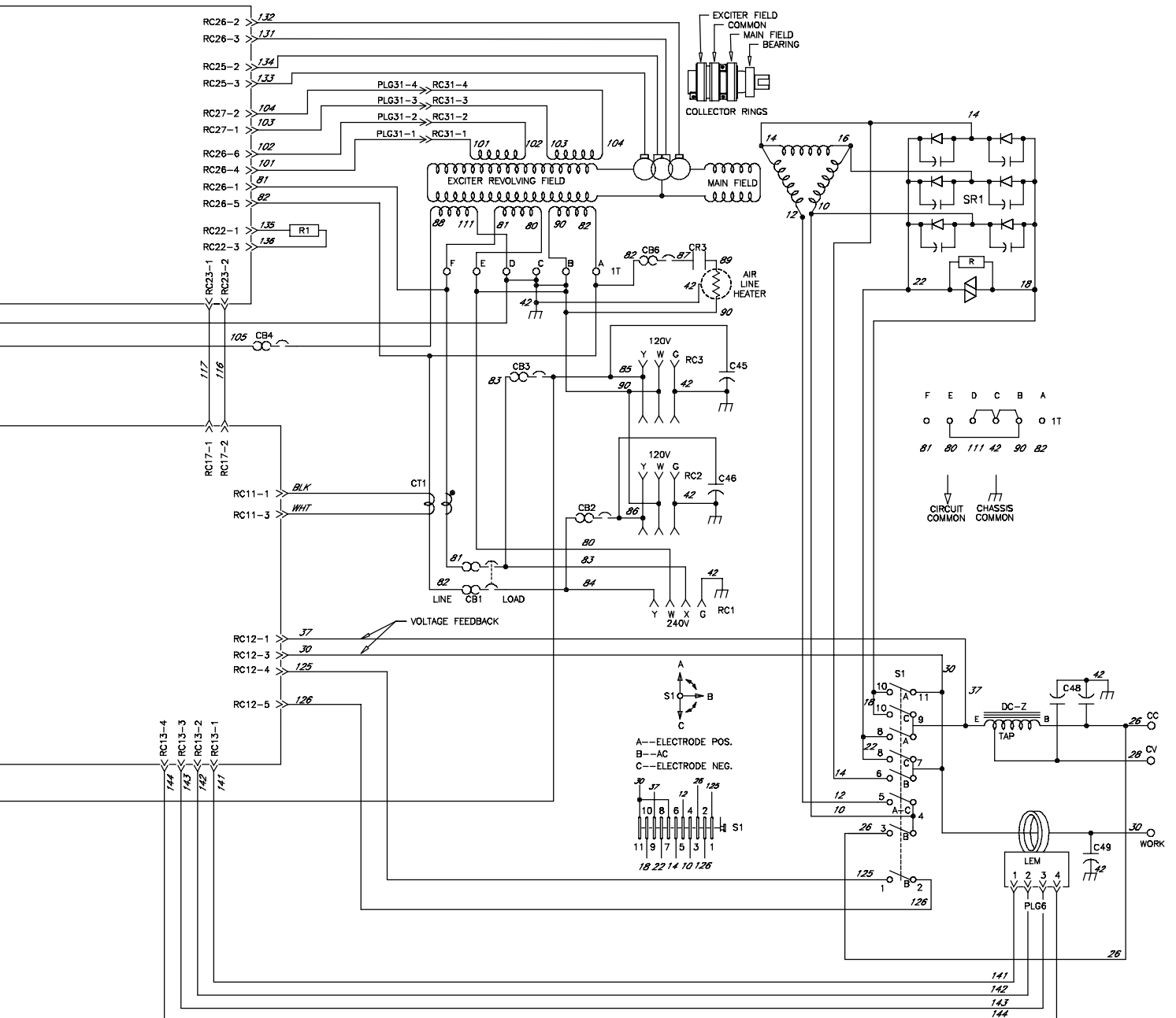

Figure 13-1. Circuit Diagram For Welding Generator



SECTION 14 – GENERATOR POWER GUIDELINES

The views in this section are intended to be representative of all engine-driven welding generators. Your unit may differ from those shown.

14-1. Selecting Equipment



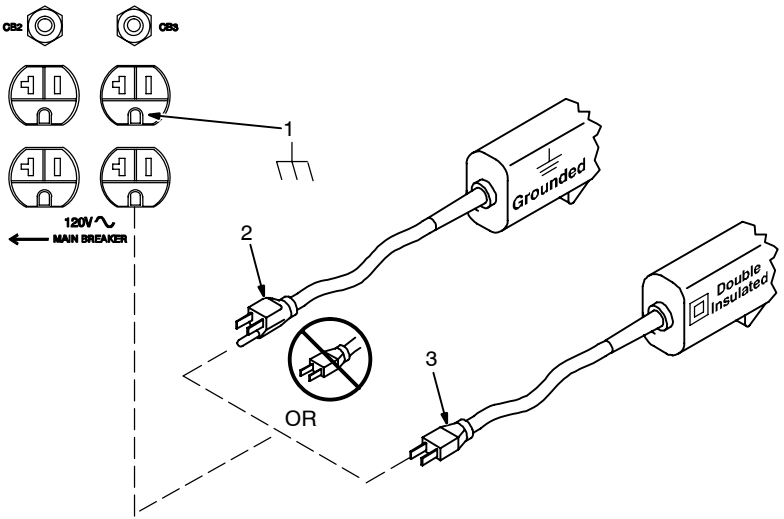

- 1 Generator Power Receptacles – Neutral Bonded To Frame
- 2 3-Prong Plug From Case Grounded Equipment
- 3 2-Prong Plug From Double Insulated Equipment

Be sure equipment has double insulated symbol and/or wording on it.

Do not use 2-prong plug unless equipment is double insulated.

gen_pwr 2008-01 – ST-800 577

14-2. Grounding Generator To Truck Or Trailer Frame

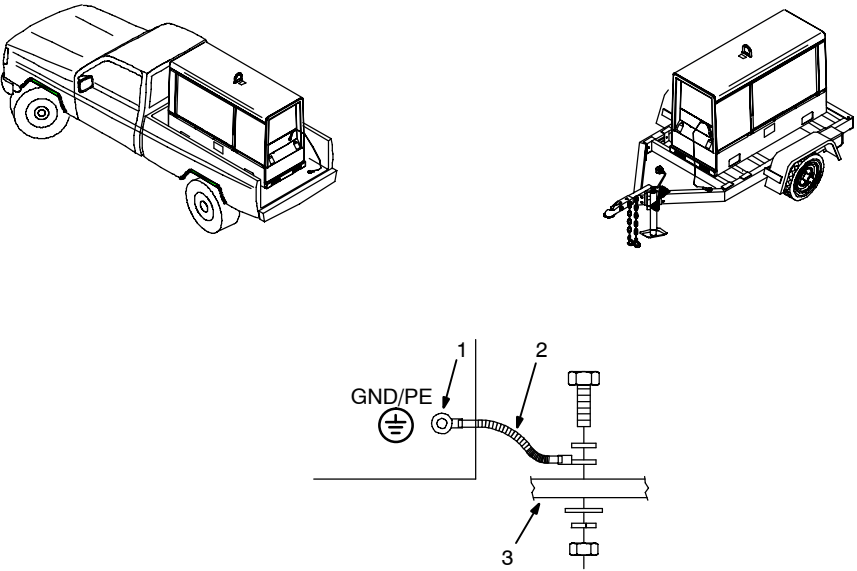

Always ground generator frame to vehicle frame to prevent electric shock and static electricity hazards.

Also see AWS Safety & Health Fact Sheet No. 29, Grounding of Portable And Vehicle Mounted Welding Generators.

- 1 Equipment Grounding Terminal (On Front Panel)
- 2 Grounding Cable (Not Supplied)
- 3 Metal Vehicle Frame

Connect cable from equipment ground terminal to metal vehicle frame. Use #10 AWG or larger insulated copper wire.

Electrically bond generator frame to vehicle frame by metal-to-metal contact.

Bed liners, shipping skids, and some running gear insulate the welding generator from the vehicle frame. Always connect a ground wire from the generator equipment grounding terminal to bare metal on the vehicle frame as shown.

If unit does not have GFCI receptacles, use GFCI-protected extension cord.

800 652-D

14-3. Grounding When Supplying Building Systems

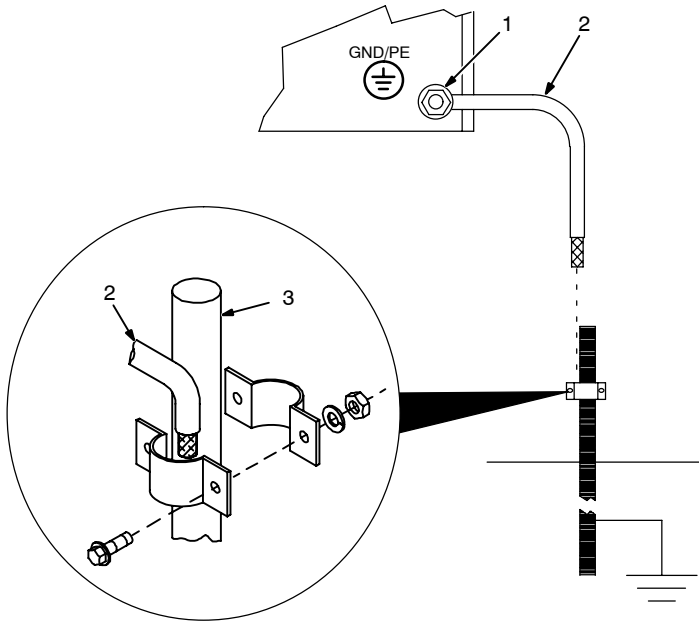

1 Equipment Grounding Terminal

2 Grounding Cable

Use #10 AWG or larger insulated copper wire.

3 Ground Device

Use ground device as stated in electrical codes.

Ground generator to system earth ground if supplying power to a premises (home, shop, farm) wiring system.

Also see AWS Safety & Health Fact Sheet No. 29, Grounding of Portable And Vehicle Mounted Welding Generators.

ST-800 576-B

14-4. How Much Power Does Equipment Require?

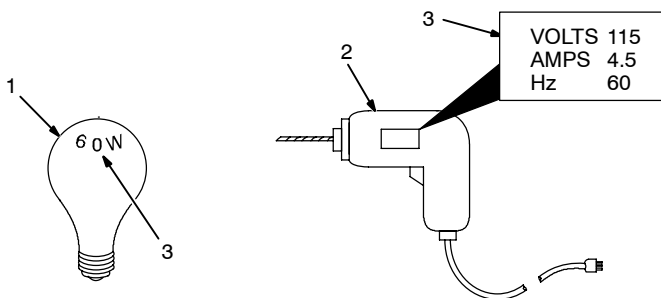

1 Resistive Load

A light bulb is a resistive load and requires a constant amount of power.

2 Non-Resistive Load

Equipment with a motor is a non-resistive load and requires approximately six times more power while starting the motor than when running (see Section 14-8).

3 Rating Data

Rating shows volts and amperes, or watts required to run equipment.

Amperes x Volts = Watts

Example 1: If a drill uses 4.5 amperes at 115 volts, calculate its running power requirement in watts.

$$4.5 \text{ A} \times 115 \text{ V} = 520 \text{ W}$$

The load applied by the drill is 520 watts.

Example 2: If three 200 watt flood lamps are used with the drill from Example 1, add the individual loads to calculate total load.

$$(3 \times 200\text{W}) + 520 \text{ W} = 1120 \text{ W}$$

The total load applied by the three flood lamps and drill is 1120 watts.

S-0623

14-5. Approximate Power Requirements For Industrial Motors

Industrial Motors	Rating	Starting Watts	Running Watts
Split Phase	1/8 HP	800	300
	1/6 HP	1225	500
	1/4 HP	1600	600
	1/3 HP	2100	700
	1/2 HP	3175	875
Capacitor Start-Induction Run	1/3 HP	2020	720
	1/2 HP	3075	975
	3/4 HP	4500	1400
	1 HP	6100	1600
	1-1/2 HP	8200	2200
	2 HP	10550	2850
	3 HP	15900	3900
Capacitor Start-Capacitor Run	5 HP	23300	6800
	1-1/2 HP	8100	2000
	5 HP	23300	6000
	7-1/2 HP	35000	8000
Fan Duty	10 HP	46700	10700
	1/8 HP	1000	400
	1/6 HP	1400	550
	1/4 HP	1850	650
	1/3 HP	2400	800
	1/2 HP	3500	1100

14-6. Approximate Power Requirements For Farm/Home Equipment

Farm/Home Equipment	Rating	Starting Watts	Running Watts
Stock Tank De-Icer		1000	1000
Grain Cleaner	1/4 HP	1650	650
Portable Conveyor	1/2 HP	3400	1000
Grain Elevator	3/4 HP	4400	1400
Milk Cooler		2900	1100
Milker (Vacuum Pump)	2 HP	10500	2800
FARM DUTY MOTORS	1/3 HP	1720	720
Std. (e.g. Conveyors,	1/2 HP	2575	975
Feed Augers, Air	3/4 HP	4500	1400
Compressors)	1 HP	6100	1600
	1-1/2 HP	8200	2200
	2 HP	10550	2850
	3 HP	15900	3900
	5 HP	23300	6800
High Torque (e.g. Barn	1-1/2 HP	8100	2000
Cleaners, Silo Unloaders,	5 HP	23300	6000
Silo Hoists, Bunk Feeders)	7-1/2 HP	35000	8000
	10 HP	46700	10700
3-1/2 cu. ft. Mixer	1/2 HP	3300	1000
High Pressure 1.8 Gal/Min	500 PSI	3150	950
Washer 2 gal/min	550 PSI	4500	1400
2 gal/min	700 PSI	6100	1600
Refrigerator or Freezer		3100	800
Shallow Well Pump	1/3 HP	2150	750
	1/2 HP	3100	1000
Sump Pump	1/3 HP	2100	800
	1/2 HP	3200	1050

14-7. Approximate Power Requirements For Contractor Equipment

Contractor	Rating	Starting Watts	Running Watts
Hand Drill	1/4 in	350	350
	3/8 in	400	400
	1/2 in	600	600
Circular Saw	6-1/2 in	500	500
	7-1/4 in	900	900
	8-1/4 in	1400	1400
Table Saw	9 in	4500	1500
	10 in	6300	1800
Band Saw	14 in	2500	1100
Bench Grinder	6 in	1720	720
	8 in	3900	1400
	10 in	5200	1600
Air Compressor	1/2 HP	3000	1000
	1 HP	6000	1500
	1-1/2 HP	8200	2200
	2 HP	10500	2800
Electric Chain Saw	1-1/2 HP, 12 in	1100	1100
	2 HP, 14 in	1100	1100
Electric Trimmer	Standard 9 in	350	350
	Heavy Duty 12 in	500	500
Electric Cultivator	1/3 HP	2100	700
Elec. Hedge Trimmer	18 in	400	400
Flood Lights	HID	125	100
	Metal Halide	313	250
	Mercury	1000	
	Sodium Vapor	1400	1000
Submersible Pump	400 gph	600	200
Centrifugal Pump	900 gph	900	500
Floor Polisher	3/4 HP, 16 in	4500	1400
	1 HP, 20 in	6100	1600
High Pressure Washer	1/2 HP	3150	950
	3/4 HP	4500	1400
	1 HP	6100	1600
55 gal Drum Mixer	1/4 HP	1900	700
Wet & Dry Vac	1.7 HP	900	900
	2-1/2 HP	1300	1300

14-8. Power Required To Start Motor

Single-Phase Induction Motor Starting Requirements								
Motor Start Code	G	H	J	K	L	M	N	P
KVA/HP	6.3	7.1	8.0	9.0	10.0	11.2	12.5	14.0



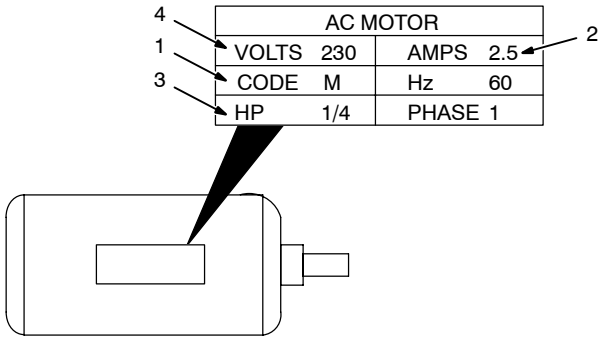

AC MOTOR			
VOLTS	230	AMPS	2.5
CODE	M	Hz	60
HP	1/4	PHASE	1

- 1 Motor Start Code
- 2 Running Amperage
- 3 Motor HP
- 4 Motor Voltage

To find starting amperage:

Step 1: Find code and use table to find kVA/HP. If code is not listed, multiply running amperage by six to find starting amperage.

Step 2: Find Motor HP and Volts.

Step 3: Determine starting amperage (see example).

Welding generator amperage output must be at least twice the motor's running amperage.

(kVA/HP x HP x 1000) / Volts = Starting Amperage

Example: Calculate starting amperage required for a 230 V, 1/4 HP motor with a motor start code of M.

Volts = 230, HP = 1/4, kVA/HP = 11.2

$(11.2 \times 1/4 \times 1000) / 230 = 12.2A$

Starting the motor requires 12.2 amperes.

S-0624

14-9. How Much Power Can Generator Supply?



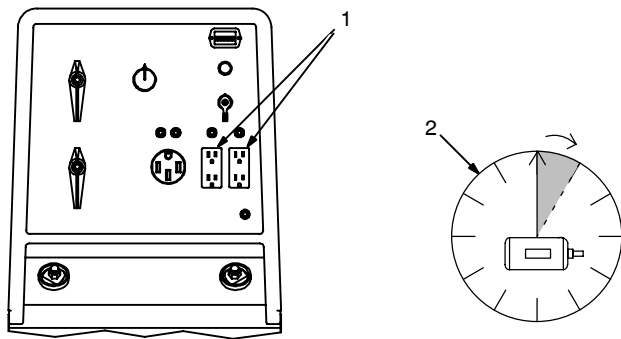

- 1 Limit Load To 90% Of Generator Output

Always start non-resistive (motor) loads in order from largest to smallest, and add resistive loads last.

- 2 5 Second Rule

If motor does not start within 5 seconds, turn off power to prevent motor damage. Motor requires more power than generator can supply.

Ref. ST-800 396-A / S-0625

14-10. Typical Connections To Supply Standby Power

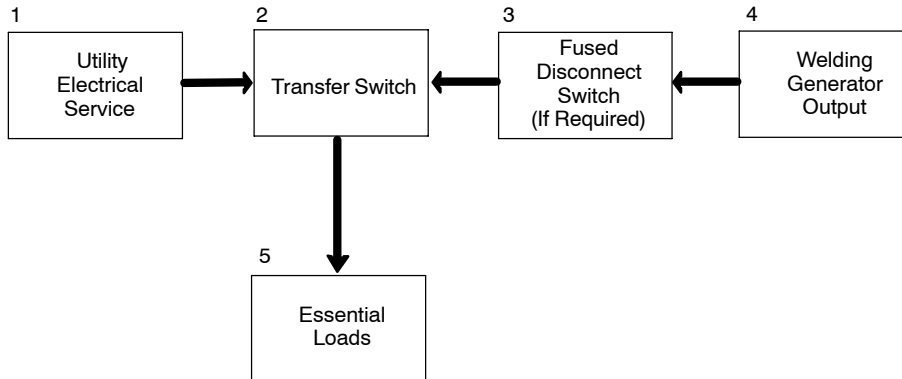

⚠ Have only qualified persons perform these connections according to all applicable codes and safety practices.

⚠ Properly install and ground this equipment according to its Owner's Manual and national, state, and local codes.

📖 *Customer-supplied equipment is required if generator will supply standby power during emergencies or power outages.*

1 Utility Electrical Service

2 Transfer Switch (Double-Throw)

Switch transfers the electrical load from electric utility service to the generator. Transfer load back to electric utility when service is restored.

Install correct switch (customer-supplied). Switch rating must be same as or greater than the branch overcurrent protection.

3 Fused Disconnect Switch

Install correct switch (customer-supplied) if required by electrical code.

4 Welding Generator Output

Generator output voltage and wiring must be consistent with regular (utility) system voltage and wiring.

Connect generator with temporary or permanent wiring suitable for the installation.

Turn off or unplug all equipment connected to generator before starting or stopping engine. When starting or stopping, the engine has low speed which causes low voltage and frequency.

5 Essential Loads

Generator output may not meet the electrical requirements of the premises. If generator does not produce enough output to meet all requirements, connect only essential loads (pumps, freezers, heaters, etc. – See Section 14-4).

14-11. Selecting Extension Cord (Use Shortest Cord Possible)

Cord Lengths for 120 Volt Loads							
							
⚠ If unit does not have GFCI receptacles, use GFCI-protected extension cord.							
Current (Amperes)	Load (Watts)	Maximum Allowable Cord Length in ft (m) for Conductor Size (AWG)*					
		4	6	8	10	12	14
5	600			350 (106)	225 (68)	137 (42)	100 (30)
7	840		400 (122)	250 (76)	150 (46)	100 (30)	62 (19)
10	1200	400 (122)	275 (84)	175 (53)	112 (34)	62 (19)	50 (15)
15	1800	300 (91)	175 (53)	112 (34)	75 (23)	37 (11)	30 (9)
20	2400	225 (68)	137 (42)	87 (26)	50 (15)	30 (9)	
25	3000	175 (53)	112 (34)	62 (19)	37 (11)		
30	3600	150 (46)	87 (26)	50 (15)	37 (11)		
35	4200	125 (38)	75 (23)	50 (15)			
40	4800	112 (34)	62 (19)	37 (11)			
45	5400	100 (30)	62 (19)				
50	6000	87 (26)	50 (15)				

*Conductor size is based on maximum 2% voltage drop

Cord Lengths for 240 Volt Loads							
							
⚠ If unit does not have GFCI receptacles, use GFCI-protected extension cord.							
Current (Amperes)	Load (Watts)	Maximum Allowable Cord Length in ft (m) for Conductor Size (AWG)*					
		4	6	8	10	12	14
5	1200			700 (213)	450 (137)	225 (68)	200 (61)
7	1680		800 (244)	500 (152)	300 (91)	200 (61)	125 (38)
10	2400	800 (244)	550 (168)	350 (107)	225 (69)	125 (38)	100 (31)
15	3600	600 (183)	350 (107)	225 (69)	150 (46)	75 (23)	60 (18)
20	4800	450 (137)	275 (84)	175 (53)	100 (31)	60 (18)	
25	6000	350 (107)	225 (69)	125 (38)	75 (23)		
30	7000	300 (91)	175 (53)	100 (31)	75 (23)		
35	8400	250 (76)	150 (46)	100 (31)			
40	9600	225 (69)	125 (38)	75 (23)			
45	10,800	200 (61)	125 (38)				
50	12,000	175 (53)	100 (31)				

*Conductor size is based on maximum 2% voltage drop

TRUE BLUE[®]

WARRANTY

Effective January 1, 2009

(Equipment with a serial number preface of LK or newer)

This limited warranty supersedes all previous Miller warranties and is exclusive with no other guarantees or warranties expressed or implied.

Warranty Questions?

Call
1-800-4-A-MILLER
for your local
Miller distributor.

Your distributor also gives
you ...

Service

You always get the fast,
reliable response you
need. Most replacement
parts can be in your
hands in 24 hours.

Support

Need fast answers to the
tough welding questions?
Contact your distributor.
The expertise of the
distributor and Miller is
there to help you, every
step of the way.

LIMITED WARRANTY – Subject to the terms and conditions below, Miller Electric Mfg. Co., Appleton, Wisconsin, warrants to its original retail purchaser that new Miller equipment sold after the effective date of this limited warranty is free of defects in material and workmanship at the time it is shipped by Miller. THIS WARRANTY IS EXPRESSLY IN LIEU OF ALL OTHER WARRANTIES, EXPRESS OR IMPLIED, INCLUDING THE WARRANTIES OF MERCHANTABILITY AND FITNESS.

Within the warranty periods listed below, Miller will repair or replace any warranted parts or components that fail due to such defects in material or workmanship. Miller must be notified in writing within thirty (30) days of such defect or failure, at which time Miller will provide instructions on the warranty claim procedures to be followed.

Miller shall honor warranty claims on warranted equipment listed below in the event of such a failure within the warranty time periods. All warranty time periods start on the delivery date of the equipment to the original end-user purchaser, and not to exceed one year after the equipment is shipped to a North American distributor or eighteen months after the equipment is shipped to an International distributor.

1. 5 Years Parts — 3 Years Labor
 - * Original main power rectifiers only to include SCRs, diodes, and discrete rectifier modules
2. 3 Years — Parts and Labor
 - * Transformer/Rectifier Power Sources
 - * Plasma Arc Cutting Power Sources
 - * Process Controllers
 - * Semi-Automatic and Automatic Wire Feeders
 - * Inverter Power Sources (Unless Otherwise Stated)
 - * Water Coolant Systems (Integrated)
 - * Intellitig
 - * Engine Driven Welding Generators
(NOTE: Engines are warranted separately by the engine manufacturer.)
3. 1 Year — Parts and Labor Unless Specified
 - * Motor Driven Guns (w/exception of Spoolmate Spoolguns)
 - * Positioners and Controllers
 - * Automatic Motion Devices
 - * RFCS Foot Controls
 - * Induction Heating Power Sources, Coolers, and Electronic Controls/Recorders
 - * Water Coolant Systems (Non-Integrated)
 - * Flowgauge and Flowmeter Regulators (No Labor)
 - * HF Units
 - * Grids
 - * Spot Welders
 - * Load Banks
 - * Fume Extractors
 - * Arc Stud Power Sources & Arc Stud Guns
 - * Racks
 - * Running Gear/Trailers
 - * Plasma Cutting Torches (except APT & SAF Models)
 - * Field Options
(NOTE: Field options are covered under True Blue[®] for the remaining warranty period of the product they are installed in, or for a minimum of one year — whichever is greater.)
 - * Bernard-Branded Mig Guns (No Labor)
 - * Weldcraft-Branded TIG Torches (No Labor)
 - * Subarc Wire Drive Assemblies
4. 6 Months — Batteries
5. 90 Days — Parts
 - * MIG Guns and Subarc (SAW) Guns

- * Induction Heating Coils and Blankets, Cables, and Non-Electronic Controls
- * APT & SAF Model Plasma Cutting Torches
- * Remote Controls
- * Accessory (Kits)
- * Replacement Parts (No labor)
- * Spoolmate Spoolguns
- * Canvas Covers

Miller's True Blue[®] Limited Warranty shall not apply to:

1. **Consumable components; such as contact tips, cutting nozzles, contactors, brushes, slip rings, relays or parts that fail due to normal wear. (Exception: brushes, slip rings, and relays are covered on Bobcat, Trailblazer, and Legend models.)**
2. Items furnished by Miller, but manufactured by others, such as engines or trade accessories. These items are covered by the manufacturer's warranty, if any.
3. Equipment that has been modified by any party other than Miller, or equipment that has been improperly installed, improperly operated or misused based upon industry standards, or equipment which has not had reasonable and necessary maintenance, or equipment which has been used for operation outside of the specifications for the equipment.

MILLER PRODUCTS ARE INTENDED FOR PURCHASE AND USE BY COMMERCIAL/INDUSTRIAL USERS AND PERSONS TRAINED AND EXPERIENCED IN THE USE AND MAINTENANCE OF WELDING EQUIPMENT.

In the event of a warranty claim covered by this warranty, the exclusive remedies shall be, at Miller's option: (1) repair; or (2) replacement; or, where authorized in writing by Miller in appropriate cases, (3) the reasonable cost of repair or replacement at an authorized Miller service station; or (4) payment of or credit for the purchase price (less reasonable depreciation based upon actual use) upon return of the goods at customer's risk and expense. Miller's option of repair or replacement will be F.O.B., Factory at Appleton, Wisconsin, or F.O.B. at a Miller authorized service facility as determined by Miller. Therefore no compensation or reimbursement for transportation costs of any kind will be allowed.

TO THE EXTENT PERMITTED BY LAW, THE REMEDIES PROVIDED HEREIN ARE THE SOLE AND EXCLUSIVE REMEDIES. IN NO EVENT SHALL MILLER BE LIABLE FOR DIRECT, INDIRECT, SPECIAL, INCIDENTAL OR CONSEQUENTIAL DAMAGES (INCLUDING LOSS OF PROFIT), WHETHER BASED ON CONTRACT, TORT OR ANY OTHER LEGAL THEORY.

ANY EXPRESS WARRANTY NOT PROVIDED HEREIN AND ANY IMPLIED WARRANTY, GUARANTY OR REPRESENTATION AS TO PERFORMANCE, AND ANY REMEDY FOR BREACH OF CONTRACT TORT OR ANY OTHER LEGAL THEORY WHICH, BUT FOR THIS PROVISION, MIGHT ARISE BY IMPLICATION, OPERATION OF LAW, CUSTOM OF TRADE OR COURSE OF DEALING, INCLUDING ANY IMPLIED WARRANTY OF MERCHANTABILITY OR FITNESS FOR PARTICULAR PURPOSE, WITH RESPECT TO ANY AND ALL EQUIPMENT FURNISHED BY MILLER IS EXCLUDED AND DISCLAIMED BY MILLER.

Some states in the U.S.A. do not allow limitations of how long an implied warranty lasts, or the exclusion of incidental, indirect, special or consequential damages, so the above limitation or exclusion may not apply to you. This warranty provides specific legal rights, and other rights may be available, but may vary from state to state.

In Canada, legislation in some provinces provides for certain additional warranties or remedies other than as stated herein, and to the extent that they may not be waived, the limitations and exclusions set out above may not apply. This Limited Warranty provides specific legal rights, and other rights may be available, but may vary from province to province.





Owner's Record

Please complete and retain with your personal records.

Model Name

Serial/Style Number

Purchase Date

(Date which equipment was delivered to original customer.)

Distributor

Address

City

State

Zip



For Service

Contact a **DISTRIBUTOR** or **SERVICE AGENCY** near you.

Always provide Model Name and Serial/Style Number.

Contact your Distributor for:

Welding Supplies and Consumables

Options and Accessories

Personal Safety Equipment

Service and Repair

Replacement Parts

Training (Schools, Videos, Books)

Technical Manuals (Servicing Information and Parts)

Circuit Diagrams

Welding Process Handbooks

To locate a Distributor or Service Agency visit www.millerwelds.com or call 1-800-4-A-Miller

Contact the Delivering Carrier to:

File a claim for loss or damage during shipment.

For assistance in filing or settling claims, contact your distributor and/or equipment manufacturer's Transportation Department.

Miller Electric Mfg. Co.

An Illinois Tool Works Company
1635 West Spencer Street
Appleton, WI 54914 USA

International Headquarters—USA

USA Phone: 920-735-4505 Auto-Attended
USA & Canada FAX: 920-735-4134
International FAX: 920-735-4125

For International Locations Visit
www.MillerWelds.com

